

# URBAN STORM DRAINAGE

VOLUME

1

CRITERIA  
MANUAL



MANAGEMENT, HYDROLOGY, AND HYDRAULICS



# **Urban Storm Drainage Criteria Manual: Volume 1 Management, Hydrology, and Hydraulics**

**Updated January 2016**

Originally Published September 1969



**Urban Drainage and Flood Control District**

2480 West 26<sup>th</sup> Avenue, Suite 156B

Denver, Colorado 80211

[www.udfcd.org](http://www.udfcd.org)

---

**Copyright 2016 by the Urban Drainage and Flood Control District (UDFCD).** All rights reserved. Printed and bound in the United States of America. Unless in conformance with the Permission to Use Statement below, no part of this publication may be reproduced, copied, transmitted, transcribed or stored in any form such as mechanical, electric, optical, chemical, manual or otherwise, without written permission from UDFCD or without the prior written permission of UDFCD. Requests for permission shall be directed to UDFCD at [udfcd@udfcd.org](mailto:udfcd@udfcd.org).

### Permission to Use

Permission granted to user by UDFCD for:

1. Individual, personal single copy reproduction for an individual use only, not for resale; or
2. Public agency, private organization, or trade association, in-house multi-copy reproduction for distribution and use within a single public agency, private organization, or trade association, not for resale.

Prior written approval of UDFCD is required by user for any other use.

### Restrictions Applicable to Commercial Reproduction

Commercial reproduction of individual or multiple copies, or portions thereof, is strictly prohibited without the prior written approval of UDFCD. Requests for permission shall be directed to UDFCD at: [udfcd@udfcd.org](mailto:udfcd@udfcd.org).



# Urban Storm Drainage Criteria Manual

## Contents

### Disclaimer

### Volume 1

#### Preface

- 1.0 Acknowledgements
- 2.0 Purpose
- 3.0 Overview
- 4.0 List of Abbreviations

#### Chapter 1 Drainage Policy

- 1.0 Policies and Principles
- 2.0 UDFCD Hydrologic Data Collection
- 3.0 Planning
- 4.0 Technical Criteria
- 5.0 Floodplain Management
- 6.0 Implementation of Urban Storm Drainage Criteria
- 7.0 References

#### Chapter 2 Drainage Law

- 1.0 Summary of Current General Principle of Drainage and Flood Control Law
- 2.0 General Principles of Drainage Law
- 3.0 Drainage Improvements by a Local Government
- 4.0 Financing Drainage Improvements
- 5.0 Floodplain Management
- 6.0 Special Matters
- 7.0 Conclusion

#### Chapter 3 Planning

- 1.0 Importance of Drainage Planning
- 2.0 Minor (Initial) Drainage System Planning
- 3.0 Drainage Master Planning Process
- 4.0 Floodplain Management
- 5.0 Multi-use Opportunities
- 6.0 References

**Chapter 4 Flood Risk Management**

- 1.0 Introduction
- 2.0 Floodplain Management Fundamentals
- 3.0 Floodplain Mapping Changes and Administration
- 4.0 Flood Insurance
- 5.0 UDFCD, Local and State Floodplain Management Programs
- 6.0 Floodproofing
- 7.0 Assistance for Property Owners
- 8.0 References
- 9.0 Glossary

**Chapter 5 Rainfall**

- 1.0 Overview
- 2.0 Rainfall Depth-Duration-Frequency
- 3.0 Design Storm Distribution for CUHP
- 4.0 Intensity-Duration Curves for Rational Method
- 5.0 Spreadsheet Design Aids
- 6.0 Examples
- 7.0 References

**Chapter 6 Runoff**

- 1.0 Overview
- 2.0 Rational Method
- 3.0 Colorado Urban Hydrograph Procedure
- 4.0 EPA SWMM and Hydrograph Routing
- 5.0 Other Hydrologic Methods
- 6.0 Software
- 7.0 Examples
- 8.0 References

**Chapter 7 Street, Inlets, and Storm Drains**

- 1.0 Introduction
- 2.0 Street Drainage
- 3.0 Inlets
- 4.0 Storm Drain Systems
- 5.0 UD-Inlet Design Workbook
- 6.0 Examples
- 7.0 References

**Chapter 8      Open Channels**

- 1.0    Introduction
- 2.0    Natural Stream Corridors
- 3.0    Preserving Natural Stream Corridors
- 4.0    Stream Restoration Principles
- 5.0    Naturalized Channels
- 6.0    Swales
- 7.0    Hydraulic Analysis
- 8.0    Rock and Boulders
- 9.0    References

**Volume 2****Chapter 9      Hydraulic Structures**

- 1.0    Structures in Streams
- 2.0    Grade Control Structures
- 3.0    Pipe Outfalls and Rundowns
- 4.0    References

**Chapter 10     Stream Access and Recreational Channels**

- 1.0    Introduction and Overview
- 2.0    Public Safety Project Review
- 3.0    Paths Adjacent to Streams
- 4.0    In-Channel Safety
- 5.0    References

**Chapter 11     Culverts and Bridges**

- 1.0    Introduction and Overview
- 2.0    Required Design Information
- 3.0    Culvert Hydraulics
- 4.0    Culvert Sizing and Designs
- 5.0    Culvert Inlets
- 6.0    Outlet Protection
- 7.0    Bridges
- 8.0    Design Examples
- 9.0    Checklist
- 10.0    References

**Chapter 12 Storage**

- 1.0 Overview
- 2.0 Implementation of Regional, Sub-regional, and On-site Detention Facilities
- 3.0 Full Spectrum Detention as the Recommended Approach
- 4.0 Sizing of Full Spectrum Detention Storage Volumes
- 5.0 Design Considerations
- 6.0 Additional Configurations of Detention Facilities
- 7.0 Designing for Operations and Maintenance
- 8.0 Design Examples
- 9.0 References

**Chapter 13 Revegetation**

- 1.0 Introduction
- 2.0 Habitat Types
- 3.0 Site Preparation
- 4.0 Plant Material Selection
- 5.0 Plant Installation
- 6.0 Mulching
- 7.0 Maintenance
- 8.0 Post-construction Monitoring
- 9.0 Conclusion
- 10.0 References

# Disclaimer

## **Attention all persons using the Urban Storm Drainage Criteria Manual (USDCM), its Design Form Spreadsheets, AutoCAD™ Details, and Related Software Products:**

The products listed above have been developed using a high standard of care, including professional review for identification of errors, bugs, and other problems related to the software. However, as with any release of publications, details, and software, errors will be discovered. The developers of these products welcome user feedback in helping to identify them so that improvements can be made to future releases of this manual and all related products.

This manual and all related products are intended to assist and streamline the planning and design process of drainage facilities. The AutoCAD™ details are intended to show design concepts. Preparation of final design plans, addressing details of structural adequacy, public safety, hydraulic functionality, maintainability, and aesthetics, remain the sole responsibility of the designer.

**By the use of the USDCM and/or related design form worksheets, spreadsheets, AutoCAD™ details, software and all other related products, the user agrees to the following:**

### **DISCLAIMER OF WARRANTIES AND DAMAGES**

THE USDCM, ITS DESIGN FORM SPREADSHEETS, AUTO CAD<sup>TH</sup> DETAILS AND RELATED SOFTWARE ARE PROVIDED BY URBAN DRAINAGE AND FLOOD CONTROL DISTRICT (“UDFCD”) AND ITS CONTRACTORS, ADVISORS, REVIEWERS AND MEMBER GOVERNMENTAL AGENCIES (“CONTRIBUTORS”) “AS IS” AND “WITH ALL FAULTS”. ANY EXPRESS OR IMPLIED WARRANTIES, INCLUDING, BUT NOT LIMITED TO, THE IMPLIED WARRANTIES OF MERCHANTABILITY AND FITNESS FOR A PARTICULAR PURPOSE ARE DISCLAIMED. IN NO EVENT SHALL UDFCD OR ITS CONTRIBUTORS BE LIABLE FOR ANY DIRECT, INDIRECT, INCIDENTAL, SPECIAL, EXEMPLARY, OR CONSEQUENTIAL DAMAGES (INCLUDING, BUT NOT LIMITED TO, PROCUREMENT OF SUBSTITUTE GOODS OR SERVICES; LOSS OF USE, DATA, INFORMATION OR PROFITS; OR BUSINESS INTERRUPTION) HOWEVER CAUSED AND ON ANY THEORY OF LIABILITY, WHETHER IN CONTRACT, STRICT LIABILITY, OR TORT (INCLUDING NEGLIGENCE OR OTHERWISE) ARISING IN ANY WAY OUT OF THE USE OF THE USDCM, ITS DESIGN FORM SPREADSHEETS, AUTOCAD<sup>TM</sup> DETAILS, AND RELATED SOFTWARE.





# Preface

## Contents

<b>1.0</b>	<b>Acknowledgements.....</b>	<b>1</b>
<b>2.0</b>	<b>Purpose.....</b>	<b>5</b>
<b>3.0</b>	<b>Overview .....</b>	<b>5</b>
<b>4.0</b>	<b>List of Abbreviations.....</b>	<b>7</b>

## 1.0 Acknowledgements

### Contributors to Original (1969) Version of the Urban Storm Drainage Criteria Manual (USDCM)

Residents of the Urban Drainage and Flood Control District (UDFCD) and many communities beyond the UDFCD boundary have benefited significantly from the pioneering vision of those who were responsible for the original (1969) version of the USDCM, including D. Earl Jones, Jr., P.E., Dr. Jack Schaeffer, Dr. Gilbert White and Kenneth R. Wright, P.E. (lead author). The vast majority of the policies, principles, and criteria in the 1969 USDCM are found in this updated (2015) version—a true testament to the wisdom of these leaders.

UDFCD wishes to acknowledge and thank all individuals and organizations that contributed to development and publication of the 2015 update of Volumes 1 and 2 of the USDCM. The lists of individuals and organizations that follow are our best effort to acknowledge all of the organizations and individuals that were directly involved in the USDCM’s preparation.

#### Urban Drainage and Flood Control District

Paul Hindman, PE	Executive Director
Ken MacKenzie, PE	Editor in Chief
Holly Piza, PE	Editor and Co-author
David Bennetts, PE	Peer Reviewer
Geanesia Hinton	Senior Administrative Assistant

#### Wright Water Engineers, Inc.

#### Chapter/Expertise

Andrew Earles, Ph.D., PE, CPESC Co-author	Multiple chapters
Jane Clary, LEED AP, CPESC Co-author	Multiple chapters
Jon Jones, PE Peer Reviewer	Multiple chapters
Ken Wright, PE Peer Reviewer	Drainage Policy, Drainage Law, Planning
Jennifer Keyes, CPESC	Revegetation
Shannon Tillack, PE, CPESC	Planning, Rainfall, Runoff
Ian Paton, PE, CFM, CPESC	Flood Risk Management
Eliot Wong, PE, CFM	Flood Risk Management
Jim Guo, Ph.D., PE Project Advisor	Rainfall, Runoff
Ben Urbonas, PE, D.WRE Project Advisor	Planning, Rainfall, Runoff

	<b>Chapter/Expertise</b>
<b>Muller Engineering Company</b> Jim Wulliman, PE Co-author	Hydraulic Structures, Storage, Open Channels
Chris Kroeger, PE Co-author	Hydraulic Structures
Tracy Bolger, PE Co-author	Hydraulic Structures, Storage, Open Channels
Carolyn Roan, PE, CFM Co-author	Hydraulic Structures
Derek Johns, PE Peer Reviewer	Hydraulic Structures, Open Channels
Joe Juergensen, PE Peer Reviewer	Hydraulic Structures, Open Channels
Glenn Hamilton, PE Peer Reviewer	Hydraulic Structures
Matt Dillon Peer Reviewer	Open Channels
Lonny Dalton	Hydraulic Structures, Open Channels
Candace Juntunen	Hydraulic Structures, Storage, Open Channels
John Keller	Hydraulic Structures
<b>IRIS Design and Mitigation, Inc.</b> Blair Leisure, M.SC., Restoration Ecologist Co-author	Revegetation
<b>Valarian, Inc.</b> Susan Brown, RLA Technical Advisor and Contributor	Revegetation
Brent Kaslon	Revegetation
<b>McLaughlin Whitewater Design Group</b> Richard McLaughlin, PE Co-author	Recreational Channels
Ben Nielson, PE Contributor	Recreational Channels
John Anderson, RA Contributor	Recreational Channels
Risa Shimoda (The Shimoda Group) Contributor	Recreational Channels
Janet Zeller (US Forest Services) Contributor	Recreational Channels

**ERO**

Janelle Kreutzer, Ecologist  
Peer Reviewer

Denise Larson, Ecologist  
Peer Reviewer

**The Restoration Group, Inc.**

Deb Keammerer, Restoration Ecologist  
Peer Reviewer

**Chapter/Expertise**

Revegetation

Revegetation

Revegetation

**Public Agency Review/Contributors**

Arapahoe County  
Arapahoe Parks and Recreation District  
Boulder County  
City and County of Denver  
City of Aurora  
City of Boulder  
City of Colorado Springs  
City of Fort Collins  
City of Greenwood Village  
City of Lakewood  
City of Littleton  
City of Lone Tree  
City of Longmont  
City of Loveland

City of Northglenn  
City of Thornton  
City of Wheat Ridge  
Colorado State University (CSU)  
CSU Extension  
Douglas County  
Highlands Ranch Metro District  
Jefferson County  
South Suburban Parks and Recreation District  
Southeast Metro Stormwater Authority  
Town of Castle Rock  
Town of Parker  
Town of Superior  
University of Colorado



**Additional Contributors**

Alan Sorrel  
Andrea Cummins  
Anne Heine  
Ashley Byerley  
Barbara Chongtoua  
Barbara Horton  
Basil Hampden  
Bill DeGroot  
Bill McCormick  
Brad Robenstein  
Brett Collins  
Bryan Kohlenberg  
Chris Taliga  
Chuck Haskins  
Corey Huwa  
Craig Coronato  
Curtis Bish  
Dan Bare  
Dan Wolford  
Darren Mollendor  
Dave Skuodas  
David Chenoweth  
David Hirt  
David Hollingsworth

David Mallory  
David VanDellen  
Doug Rockne  
Douglas Hintzman  
Forrest Dykstra  
Fred Bromberger  
Jacob James  
James Kaiser  
Jay Henke  
Jerry Naranjo  
Jessica Lammers  
Jessica Stevens  
Jim Krick  
Jim Lenhart  
Jim Meining  
Joanna Czarnecka  
Joe Williams  
Julie Ash  
Kevin Gingery  
Kurt Kowar  
Larry Roesner  
Laura Kroeger  
Mark Westberg  
Mike Banovich

Mike Sarmento  
Monica Bortolini  
Pam Acre  
Pat O'Connell  
Paul Danley  
Rena Brand  
Rich Borchardt  
Rick Schmitt  
Ross Klopf  
Saeed Farahmandi  
Sandy Pralle  
Sarah Anderson  
Shea Thomas  
Stephanie Dreiling  
Suzanne Moore  
Ted Christianson  
Teresa Patterson  
Terri Fead  
Tom Repp  
Tom Williams  
Walt Hime  
Ward Mahanke

## 2.0 Purpose

Volumes 1 and 2 of the USDCM provide guidance for engineers, planners, landscape architects, developers, and contractors in selecting, designing, constructing, and maintaining stormwater drainage and flood control facilities. Volumes 1 and 2 focus primarily on stormwater quantity management for drainage and flood control purposes. Volume 3 focuses on smaller, more frequently occurring events that have a greater overall impact on the quality of receiving waters.

## 3.0 Overview

This manual is organized according to the following:

- **Chapter 1: Drainage Policy.** Adequate drainage for urban areas is necessary to preserve and promote the general health, welfare, and economic well-being of the region. The *Policy* chapter lists the 12 principles that guide all the criteria in this manual. Additionally, the chapter includes several policies that support good stormwater and floodplain management as well as the goals and actions of UDFCD.
- **Chapter 2: Drainage Law.** This chapter deals with the general principles of drainage law along with local government drainage actions, financing, floodplain management, and special matters. The information provided in this chapter is specific to the State of Colorado.
- **Chapter 3: Planning.** The urban storm drainage system is a subsystem of the total urban infrastructure system and should be integrated with other subsystems including transportation, parks, open space, and utilities. This chapter identifies and discusses key considerations in the planning process. The chapter also describes types of master plans and outlines the master planning process.
- **Chapter 4: Flood Risk Management.** This chapter addresses programs and policies adopted by UDFCD to manage flood risks and reduce potential losses from flood events. This chapter also provides guidance for specific physical measures that can be implemented to help protect individual structures from flood damage.
- **Chapter 5: Rainfall.** The *Rainfall* chapter provides rainfall depth, duration, intensity, and frequency data and analytical methods used to develop the rainfall information needed to carry out the hydrological analysis described in the *Runoff* chapter of the USDCM. This chapter also provides guidance for development of rainfall distributions for use with the Colorado Urban Hydrograph Procedure (CUHP) and Depth Reduction Factor (DRF) adjustments for use when analyzing watersheds in of 5 square miles or more. There is also a companion workbook, UD-Rain, available at [www.udfcd.org](http://www.udfcd.org) that allows the user to perform calculations in accordance with these criteria.
- **Chapter 6: Runoff.** The *Runoff* chapter presents five methods for hydrologic analysis. Peak rate of runoff, runoff volume, and the time distribution of flow provide the basis for all planning, design, and construction of drainage facilities. There is also a companion workbook, UD-Rational, available on the UDFCD website, that applies the Rational Method to estimate stormwater runoff and peak flows from small urban catchments.
- **Chapter 7: Streets, Inlets, and Storm Drains.** This chapter presents design for both stormwater collection and conveyance utilizing streets and storm drains. Inlet capacity, as presented in this chapter, is based on FHWA Hydraulic Circular No. 22 (HEC-22) methodology which was subsequently refined through a multijurisdictional partnership led by UDFCD, where hundreds of

- physical model tests of inlets commonly used in Colorado were performed at the Colorado State University (CSU) hydraulics laboratory. UD-Inlet, available on the UDFCD website, is a companion workbook that allows the user to calculate inlet capacity in accordance with these criteria.
- **Chapter 8: Open Channels.** This chapter presents principles of stream restoration along with special design considerations for constrained urban streams. There is a focus on preservation, enhancement, and restoration of stream corridors. The chapter also includes design of new channels and swales, methods for bank stabilization, and rock sizing.
- **Chapter 9: Hydraulic Structures.** This chapter includes design of various types of grade control structures including check structures, grouted stepped (or sloped) boulder drop structures, sculpted concrete drop structures, and vertical drop structures. Pipe outfalls and rundowns are also included in this chapter.
- **Chapter 10: Stream Access and Recreational Channels.** This chapter provides criteria related to the design of shared-use paths adjacent to streams and criteria for responsible design of recreational channels including boatable channels. The topics in this chapter are largely related to safety; therefore, this chapter also summarizes all criteria related to safety elsewhere in the USDCM and includes guidance for reviewing a project from the standpoint of public safety.
- **Chapter 11: Culverts and Bridges.** This chapter addresses the hydraulic function of culverts and bridges, i.e., conveyance of surface water through embankments such as roadways and railroads. UD-Culvert is a companion workbook available on the UDFCD website that aids in analyzing the flow conditions in circular and box culverts.
- **Chapter 12: Storage.** This chapter provides guidance for the analysis and design of storage facilities that are implemented independently or in combination with stormwater quality facilities. UD-FSD and UD-Detention, both available on the UDFCD website, are companion workbooks to this chapter that allow the user to design or review almost any type and configuration of detention storage facility.
- **Chapter 13: Revegetation.** This chapter provides guidelines and recommendations for revegetation efforts associated with drainage and water quality facilities. The guidance addresses three habitat types: uplands, riparian areas, and wetlands. For each habitat type, guidance is provided with regard to site preparation, plant material selection and installation, maintenance and post-construction monitoring.

A reference section is provided for each chapter, and additional materials and insight on the topics presented in the USDCM may be found by studying the papers and documents listed at the end of each chapter.

The USDCM provides criteria and standards recommended by UDFCD. Designing facilities that go beyond minimum criteria is encouraged. In addition, there may be other requirements by local, state and federal agencies that may have to be met in addition to the minimum criteria provided herein.

## 4.0 List of Abbreviations

### Commonly Used Abbreviations

ASCE	American Society of Civil Engineers
ASTM	American Society for Testing and Materials
BEF	Base flood elevation
BMP	Best management practice
CDOT	Colorado Department of Transportation
CDPHE	Colorado Department of Public Health and Environment
CMP	Corrugated metal pipe
CRS	Colorado Revised Statute(s)
CUHP	Colorado Urban Hydrograph Procedure
CWCB	Colorado Water Conservation Board
DCIA	Directly connected impervious area
DRCOG	Denver Regional Council of Governments
EGL	Energy grade line
EPA	U.S. Environmental Protection Agency
FAA	Federal Aviation Administration
FEMA	Federal Emergency Management Agency
FHAD	Flood Hazard Area Delineation
FHWA	Federal Highway Administration
FIRM	Flood Insurance Rate Map
FIS	Flood Insurance Study
FPE	Flood protection elevation
GSB	Grouted stepped or sloping boulder drop structure
HGL	Hydraulic grade line
HUD	U.S. Department of Housing and Urban Development

H:V	Horizontal to vertical ratio of a slope
ICC	Increased cost of compliance
LID	Low impact development
MDCIA	Minimized directly connected impervious area
NAVD	North American Vertical Datum
NFIA	National Flood Insurance Act
NFIP	National Flood Insurance Program
NGVD	National Geodetic Vertical Datum
NOAA	National Oceanic and Atmospheric Administration
NPDES	National Pollutant Discharge Elimination System
NRCS	Natural Resources Conservation Service
PMP	Probable maximum precipitation
RCP	Reinforced concrete pipe
SBA	Small Business Administration
SEO	Colorado State Engineer's Office
SFHA	Special Flood Hazard Area
SFIP	Standard Flood Insurance Policy
SWMM	EPA Stormwater Management Model
TABOR	Taxpayer Bill of Rights
UDSWM	Urban Drainage Stormwater Management Model
USACE	U.S. Army Corps of Engineers
USGS	U.S. Geological Survey
WEF	Water Environment Federation
WQCV	Water quality capture volume



**Commonly Used Units**

cfs	cubic feet per second
cfs/ft	cubic feet per second per foot
ft	foot
ft <sup>2</sup>	square feet
ft/ft	foot per foot
ft/sec	feet per second
ft/sec <sup>2</sup>	feet per second squared
hr	hour
in	inch
in/hr	inches per hour
in/hr/ac	inches per hour per acre
lbs	pounds
lbs/cy	pounds per cubic yard
lbs/ft <sup>2</sup>	pounds per square foot
lbs/ft <sup>3</sup>	pounds per cubic foot
lbs PLS/acre	pounds pure live seed per acre
min	minute
psi	pounds per square inch
psf	pounds per square foot

# Chapter 1

## Drainage Policy

### Contents

<b>1.0</b>	<b>Policies and Principles .....</b>	<b>1</b>
1.1	Principles.....	2
1.2	Basic Hydrologic Data Collection Policies .....	4
1.3	Planning Policies.....	4
1.4	Technical Criteria.....	5
1.5	Flood Insurance Policy.....	6
1.6	Levee Policy.....	6
1.7	Criteria Implementation Policies.....	6
<b>2.0</b>	<b>UDFCD Hydrologic Data Collection .....</b>	<b>8</b>
<b>3.0</b>	<b>Planning .....</b>	<b>9</b>
3.1	Total Urban System.....	9
3.1.1	Planning Process Elements .....	9
3.1.2	Master Planning .....	10
3.1.3	Floodplain Easements .....	10
3.1.4	Local and Regional Planning .....	11
3.1.5	Development and Site Planning.....	11
3.1.6	Managing Runoff from Frequently Occurring Storms.....	12
3.1.7	Separation of Stormwater and Sanitary Flows.....	13
3.2	Multiple-Objective Considerations .....	13
3.3	Avoiding Transfer of Problems.....	14
3.4	Detention and Retention Storage.....	15
3.4.1	Upstream Storage.....	15
3.4.2	Downstream Storage .....	16
3.4.3	Reliance on Privately Controlled Facilities and Water Storage Reservoirs .....	16
3.4.4	Reliance on Embankments.....	16
<b>4.0</b>	<b>Technical Criteria .....</b>	<b>16</b>
4.1	Intended Use of Design Criteria .....	16
4.2	Initial and Major Drainage Criteria .....	16
4.2.1	Design Storm Return Periods for Initial and Major Drainage Systems .....	16
4.2.2	Critical Facilities.....	17
4.2.3	Runoff Computations.....	17
4.2.4	Joint Probability Computations.....	18
4.2.5	Open Channels for Major Drainage .....	18
4.3	Use of Streets .....	18
4.4	Use of Irrigation Ditches .....	20
4.5	Water Quality Treatment.....	21
4.6	Maintenance of Storage and Water Quality Facilities.....	21
<b>5.0</b>	<b>Floodplain Management.....</b>	<b>21</b>
5.1	Purpose.....	21
5.2	Goals .....	22
5.3	National Flood Insurance Program.....	22
5.4	Floodplain Management.....	22
5.5	Floodplain Filling.....	23

5.6	New Development.....	23
5.7	Floodplain Management Strategies and Tools .....	24
<b>6.0</b>	<b>Implementation of Urban Storm Drainage Criteria .....</b>	<b>25</b>
6.1	Adoption and Use of the USDCM and Master Plans .....	25
6.2	Governmental Participation.....	25
6.3	Amendments to Criteria .....	25
6.4	Financing Drainage Improvements .....	25
<b>7.0</b>	<b>References .....</b>	<b>26</b>

## Tables

Table 1-1.	Design storms and purposes of initial and major drainage systems .....	17
Table 1-2.	Reasonable use of streets for initial storm runoff in terms of pavement encroachment.....	19
Table 1-3.	Major storm maximum street ponding depth .....	19
Table 1-4.	Maximum allowable cross-street flows.....	19
Table 1-5.	Floodplain management strategies and tools.....	24

## Figures

Figure 1-1.	Urban Drainage and Flood Control District (UDFCD) boundary.....	7
-------------	---	---

## 1.0 Policies and Principles

Adequate drainage for urban areas is necessary to preserve and promote the general health, welfare, and economic well-being of the region. Drainage is a regional phenomenon that affects all governmental jurisdictions and all parcels of property. This characteristic of drainage makes it necessary to formulate a program that balances both public and private involvement (Wright-McLaughlin Engineers 1969). Overall, the governmental entities most directly involved must provide coordination and master planning, but drainage planning must also be integrated on a regional level (FEMA 1995).



**Photograph 1-1.** Local grass channel after 35 years of service. Ann Spirm of the Massachusetts Institute of Technology refers to this channel as “urban poetry” in her publications.

The underlying principles in this chapter provide direction for planning drainage facilities. These principles are made operational through a set of policy statements. The application of the policy is, in turn, facilitated by technical drainage criteria, which are the focus of this manual. When considered in a comprehensive manner, at a regional level and with public and private involvement, drainage facilities can enhance the general health and welfare of the region and assure optimum economic and social relationships while avoiding uneconomic flood losses and disruption (White 1945).

### Urban Storm Drainage Criteria Manual (1969 – present)

“The time is ripe in the Denver Region for implementation of a new and more thorough approach to storm drainage as it relates to urban problems. This manual was written in an attempt to provide the various techniques, methodology, and guidelines to achieve that objective.” --Kenneth Wright, March 15, 1969

“To the best of our knowledge, the USDCM is the first such standard prepared for implementation throughout an American metropolitan area. Its adoption will permit consistent reactions to basic problems that are independent of political subdivision boundaries. Its philosophy provides for flexible approaches to realization of necessary drainage control and total water resources objectives, and at the same time encourages improved sensitivity to the total ecology. We believe these approaches will save your region many millions of dollars through the years to come by reducing drainage construction costs and flood hazard exposure, at the same time enhancing the quality of urban life.” --D. Earl Jones, U.S. Department of Housing and Urban Development (HUD), February 10, 1970

All residents of the area have benefited significantly from the pioneering vision of those who were responsible for the original (1969) version of the Urban Storm Drainage Criteria Manual, including Kenneth R. Wright, P.E., D. Earl Jones, Jr., P.E., Dr. Jack Schaeffer, Joe Shoemaker, and Dr. Gilbert White. The vast majority of the policies, principles, and criteria in the 1969 manual were retained in the 2001 and 2016 updates—a true testament to the wisdom of these leaders. This 2016 update builds upon the foundation that they provided more than 40 years ago.

UDFCD's principles and policies for urban storm drainage and floodplain management are briefly summarized in this section, followed by discussion of these policies in the remainder of the chapter.

## 1.1 Principles

Since 1969, UDFCD has embraced principles of drainage planning that guide the criteria in this manual. When these principles are followed, drainage planning and decisions are made in a consistent manner, considering both public safety and environmental protection. These time-tested principles include:

1. **Drainage is a regional phenomenon that does not respect the boundaries between government jurisdictions or between properties.** This makes it necessary to formulate programs that include both public and private involvement. Overall, the governmental entities most directly involved must provide coordination and master planning, but drainage planning must be integrated on a regional level if optimum results are to be achieved. The manner in which proposed drainage systems fit into existing regional systems must be quantified and discussed in the master plan.
2. **A storm drainage system is a subsystem of the total urban water resource system.** Stormwater system planning and design for any site must be compatible with comprehensive regional plans and should be coordinated with planning for land use, open space and transportation. Erosion and sediment control, flood control, site grading criteria, and water quality all closely interrelate with urban stormwater management. Any individual master plan or specific site plan should normally address all of these considerations.
3. **Every urban area has an initial (i.e., minor) and a major drainage system, whether or not they are actually planned and designed.** The initial drainage system, sometimes referred to as the "minor system," is designed to provide public convenience and to accommodate moderate, frequently occurring flows. The major system carries more water and operates when the rate or volume of runoff exceeds the capacity of the minor system. Both systems should be carefully considered.
4. **Runoff routing is primarily a space allocation problem.** The volume of water present at a given point in time in an urban region cannot be compressed or diminished. Channels and storm drains serve both conveyance and storage functions. If adequate provision is not made for drainage space demands, stormwater runoff will conflict with other land uses, result in damages, and impair or disrupt the functioning of other urban systems.
5. **Planning and design of stormwater drainage systems should not be based on the premise that problems can be transferred from one location to another.** Urbanization tends to increase downstream peak flow by increasing runoff volumes and velocities. Stormwater runoff can be stored and slowly released via detention facilities to manage peak flows, thereby reducing the drainage capacity required immediately downstream.
6. **An urban storm drainage strategy should be a multi-objective and multi-means effort.** The many competing demands placed upon space and resources within an urban region argue for a drainage management strategy that meets a number of objectives, including water quality enhancement, groundwater recharge, recreation, wildlife habitat, wetland creation, protection of landmarks/amenities, control of erosion and sediment deposition, and creation of open spaces.
7. **Design of the storm drainage system should consider the features and functions of the existing drainage system.** Every site contains natural features that may contribute to the management of stormwater without significant modifications. Existing features such as natural streams, depressions, wetlands, floodplains, permeable soils, and vegetation provide for infiltration, help control the velocity of runoff, extend the time of concentration, filter sediments and other pollutants, and recycle

nutrients. Each development plan should carefully map and identify the existing natural system. Techniques that preserve or protect and enhance the natural features are encouraged. Good designs improve the effectiveness of natural systems rather than negate, replace or ignore them.

8. **In conjunction with new development and redevelopment, coordinated efforts should be made to minimize increases in, and reduce where possible, stormwater runoff volumes, flow rates, and pollutant loads to the maximum extent practicable.** Key practices include:
  - The perviousness of the site and natural drainage paths should be preserved to the extent feasible. Areas conducive to infiltration of runoff should be preserved and integrated into the overall runoff management strategy for the site.
  - The rate of runoff should be slowed. Preference should be given to stormwater management systems that maximize vegetative and pervious land cover. These systems will promote infiltration, filtering and slowing of the runoff. It should be noted that, due to the principle of mass conservation, it is virtually impossible to prevent increases in post-development runoff volumes for all storm events when an area urbanizes. Existing stormwater regulations typically require control of peak flows to predevelopment levels to the maximum extent practicable, and increasingly, regulatory agencies are implementing requirements focused on the control of runoff volumes for smaller, frequently occurring events. Increased flow volumes may not cause flooding problems if a watershed has a positive outfall to a stream or river; however, increases in runoff volumes may cause problems for small, enclosed watersheds (i.e. draining to a lake) or into streams of limited capacity. Increases in runoff volumes, if not appropriately managed, can also adversely affect stream stability.
  - Pollution control is best accomplished by implementing a series of measures, which can include source controls, minimizing directly connected impervious area, and construction of on-site and regional facilities to control both runoff and pollution. Implementing measures that reduce the volume of runoff produced by frequently occurring events through infiltration and disconnection of impervious areas is one of the most effective means for reducing the pollutant load delivered to receiving waters.
9. **The stormwater management system should be designed beginning with the outlet or point of outflow from the project, giving full consideration to downstream effects and the effects of off-site flows entering the system.** The downstream conveyance system should be evaluated to ensure that it has sufficient capacity to accept design discharges without adverse upstream or downstream impacts such as flooding, stream bank erosion, and sediment deposition. In addition, the design of a drainage system should take into account the runoff from upstream sites, recognizing their future development runoff potential (e.g., imperviousness).
10. **The stormwater management system requires regular maintenance.** Failure to provide proper maintenance reduces both the hydraulic capacity and pollutant removal efficiency of the system. The key to effective maintenance is clear assignment of responsibilities to an established entity and a regular schedule of inspections to determine maintenance needs and to ensure that required maintenance is conducted. Local maintenance capabilities should be a consideration when selecting specific design criteria for a given site or project.
11. **Floodplains should be preserved whenever feasible and practicable.** Nature has claimed a prescriptive easement for floods, via its floodplains, that cannot be denied without public and private cost. Floodplain encroachment must not be allowed unless competent engineering and planning have proven that flow capacity is maintained, risks of flooding are defined, and risks to life and property are strictly minimized. Preservation of floodplains is a policy of UDFCD to manage flood hazards,

preserve habitat and open space, create a more livable urban environment, and protect the public health, safety, and welfare (White 1945).

12. **Reserve sufficient right-of-way for lateral movement of incised floodplains.** Whenever an urban floodplain is contained within a narrow non-engineered channel, its lateral movement over time can cause extensive damage to public and private structures and facilities. For this reason, whenever such a condition exists, it is recommended that, at a minimum, the channel be provided with grade control structures and a right-of-way corridor be preserved of a width corresponding to normal depth calculations for the future stable channel geometry, plus maintenance access requirements.

## 1.2 Basic Hydrologic Data Collection Policies

1. A program for collecting and analyzing storm runoff and flood data should be maintained so that intelligent and orderly planning may be undertaken for storm drainage facilities.
2. A program should be maintained to delineate flood hazard areas along all waterways in urbanized areas and in areas that may be urbanized in the future. This program should make full use of the information and data from the Federal Emergency Management Agency (FEMA), the U.S. Geological Survey (USGS), private consulting engineers, and the Colorado Water Conservation Board (CWCBC). This information should be regularly reviewed and updated to reflect changes due to urbanization, changed channel conditions, climate change, and the occurrence of extraordinary hydrologic events.
3. Before commencing design of any drainage project, comprehensive facts and data should be collected and examined for the particular watershed and area under consideration, and the basis for the design should then be agreed upon by the governmental entities affected.

## 1.3 Planning Policies

1. Storm drainage is a part of the total urban environmental system. Therefore, storm drainage planning and design must be compatible with comprehensive regional plans. A master plan for storm drainage should be developed and maintained in an up-to-date fashion at all times for each urbanizing drainage watershed.
2. The planning for drainage facilities should be coordinated with planning for open space and transportation. By coordinating these efforts, new opportunities may be identified that can help solve drainage problems. Natural streams should be used to convey storm runoff wherever feasible. Major consideration must be given to the floodplains and open space requirements of the area (White 1945).
3. Planning and design of stormwater drainage systems should not be based on the premise that problems can be transferred from one location to another.
4. Storage of runoff in detention and retention reservoirs can reduce the drainage conveyance capacity

### Accessing UDFCD Hydrologic Data, Floodplain Maps and Flood Alert System

Much of the hydrologic data originally envisioned in the 1960s is now readily available on the UDFCD website ([www.udfcd.org](http://www.udfcd.org)) and is accessible for developers, engineers, local governments, and the general public.

requirement immediately downstream. Acquisition of open space adjacent to streams provides areas where storm runoff can spread out and be stored for slower delivery downstream.

5. Runoff from small, frequently occurring storms should be managed to reduce runoff peak flows, volumes (where feasible) and pollutant loading to streams. Management of these frequently occurring events helps to protect beneficial uses of streams and promotes channel stability.

#### **1.4 Technical Criteria**

- Storm drainage planning and design should follow the criteria developed and presented in this Urban Storm Drainage Criteria Manual (USDCM).
- Every urban area has two separate and distinct drainage systems, whether or not they are actually planned and designed. One is the initial system, and the other is the major system. To provide for orderly urban growth, reduce costs to future generations and avoid loss of life and major property damage, both systems must be properly planned, engineered and maintained.
- The determination of runoff magnitude should be by the Rational Formula, the Colorado Urban Hydrograph Procedure (CUHP), or statistical analyses based on an adequate record of actual measured flood occurrences as set forth in the Runoff chapter of this manual. The method of statistical analysis is very problematic for watersheds that lack stationarity, (i.e., have been altered via urbanization or other physical changes over the record of measured floods).
- Use of streets for urban drainage should fully recognize that the primary use of streets is for traffic. Streets should not be used as floodways for initial storm runoff. Usability of the street during minor storms and reduction of street maintenance costs should be objectives of urban drainage design.
- Irrigation ditches should not be used as outfall points for initial or major drainage systems, unless such use is shown to be without unreasonable hazard, as substantiated by thorough hydraulic engineering analysis, and written approval of the ditch owner(s) is obtained. In addition, irrigation ditches cannot be relied on to mitigate upstream runoff.
- Proper design and construction of stormwater detention basins and retention ponds is necessary to minimize future maintenance and operating costs and to avoid public nuisances, health hazards, and safety hazards. This is particularly important, given the many detention and retention facilities in an urban area.
- Management of runoff from frequently occurring storm events should include four steps: 1) employing runoff reduction practices, 2) implementing best management practices (BMPs) that provide a water quality capture volume with slow release and/or infiltration, 3) stabilizing streams and 4) implementing site-specific and other source control BMPs, as needed. See Chapter 1, Volume 3 of the USDCM for additional information on the four-step process.
- The various governmental entities within the UDFCD boundary have adopted floodplain management programs, which must be maintained over the long-term. Floodplain management must encompass comprehensive criteria designed to encourage the adoption of permanent measures that will lessen the



- Exposure of life, property and facilities to flood losses, improve the long-range land management and use of flood-prone areas, and inhibit, to the maximum extent feasible, unplanned and economically unjustifiable future development in such areas.

### **1.5 Flood Insurance Policy**

Flood insurance is an integral part of the strategy to manage flood losses. UDFCD encourages the continued participation of local governments in the National Flood Insurance Program, as set forth in the National Flood Insurance Act (NFIA) of 1968, as amended.

### **1.6 Levee Policy**

1. UDFCD strongly discourages local governments from authorizing or permitting the use of levees in regard to new development in flood hazard areas.
2. UDFCD will consider levees to protect existing development only as a last resort when no other mitigation option is feasible.

### **1.7 Criteria Implementation Policies**

1. The USDCM should continue to be adopted by all governmental entities operating within the UDFCD boundary (Figure 1-1).
2. Each level of government is encouraged to participate in a successful drainage program.
3. Problems in urban drainage administration encountered by governmental entities can be reviewed by UDFCD to determine if equity or public interests indicate a need for drainage policy, practice, or procedural amendments. The financing of storm drainage improvements is fundamentally the responsibility of the affected property owners—both those directly affected by the water and those from whose land the water flows.

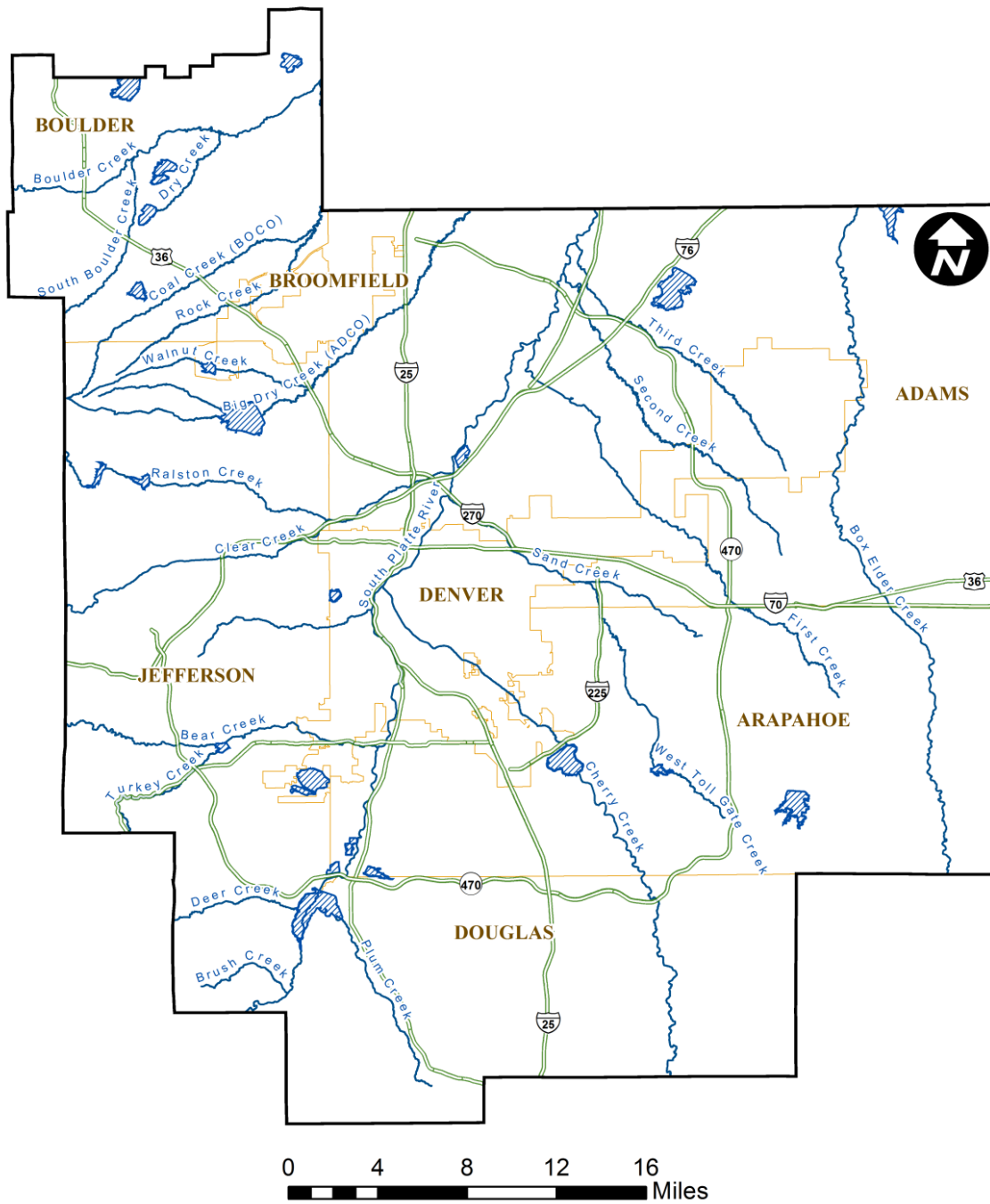


Figure 1-1. Urban Drainage and Flood Control District (UDFCD) boundary

## 2.0 UDFCD Hydrologic Data Collection

A well developed and systematic inventory of basic hydrologic data and knowledge provides the foundation for sound decision making that protects the public health, safety and welfare and results in effective use of public funds. Prior to the commencement of any drainage project, comprehensive facts and data are collected and examined for the particular watershed and area under consideration. The following key information leads to scientifically-based and cost-effective drainage planning:

- **Data Collection Program.** An important step in a drainage program is to get the facts. A program for collecting and analyzing storm runoff and flood data is maintained to promote intelligent and orderly planning (Jones 1967).
- **Storm Runoff and Flood Damage Data.** Storm runoff and flood damage data should be collected in a systematic and uniform manner.
- **Rainfall-Runoff Characterization.** A program is maintained to collect and analyze rainfall-runoff relationships in urbanized portions of the UDFCD boundary.
- **Inventory of Successful Projects.** Some drainage projects function better than others. It is important to determine why, so that key features may be identified for use on future projects.
- **Publicly Accessible UDFCD Library.** As a key component of UDFCD's education and outreach program, UDFCD actively maintains an electronic library of drainage master planning studies, as-built drawings, maps, hydrologic data and guidance documents, which is available for use by all governmental entities, planners, and engineers. The public is encouraged to access this library through the UDFCD website ([www.udfcd.org](http://www.udfcd.org)). Additionally, archived material (hydrologic and hydraulic models, master planning study technical appendices, etc.) may be made available by email request to [udfcd@udfcd.org](mailto:udfcd@udfcd.org).
- **Runoff Magnitude Records.** Where practical, the magnitude of computed and measured runoff peaks is tabulated for UDFCD streams and gulches so that comparisons may be readily made between watersheds and erroneous values may be more easily identified.
- **Floodplain Data.** A program to delineate flood hazard areas along all waterways within the UDFCD boundary is maintained by UDFCD. This program makes full use of UDFCD's Flood Hazard Area Delineation (FHAD) studies, FEMA Flood Insurance Studies, Natural Resources Conservation Service and USGS data, and floodplain studies by others. This information is regularly reviewed and updated to reflect changes due to urbanization, changed stream conditions, and the occurrence of extraordinary hydrologic events.
  - **Small Streams.** Small streams and other waterways, which are often overlooked, have a large damage potential. These waterways should receive early attention in areas subject to urbanization. Floodplain information should be shown on preliminary and final subdivision plats, including the areas inundated by major storm runoff and areas of potential erosion.
  - **Central UDFCD Database.** Floodplain data and mapping is stored in a central UDFCD depository available to all planners, developers, and engineers. All floodplain mapping, master planning documents, and FHADs, as well as many, design reports, as-builts and other UDFCD documents, are now available online in a database that is searchable by waterway, document type, keywords, etc.

- **Floodplains.** Floodplain management efforts should focus on developing information in areas that have a one percent chance of being inundated in any given year—that is, the 100-year floodplain. Local governmental entities may choose to regulate floodplains for other frequencies of flooding; however, the 100-year floodplain based on runoff from the projected fully urbanized watershed must be defined and is the minimum basis for regulation.
- **Priority for Data Acquisition.** UDFCD has established priorities for data acquisition because it recognizes that not all of the desired data can be collected at one time. When setting priorities, consideration is given to 1) areas of rapid urban growth, 2) drainage problem areas, 3) local interest and capabilities in floodplain management, and 4) the potential for developing high-quality, robust data sets.

## 3.0 Planning

### 3.1 Total Urban System

Storm drainage is a part of the total urban environmental system. Therefore, storm drainage planning and design should be compatible with comprehensive regional plans. Master plans for storm drainage have been developed and are maintained in an up-to-date fashion for most of the watersheds in the UDFCD region. An effort to complete the coverage of master plans for yet unplanned areas of UDFCD should be continued until full coverage is achieved.

#### 3.1.1 Planning Process Elements

Good urban drainage planning is a complex process. Fundamentals include:

1. **Major Drainage Planning:** Local and regional planning should consider the major drainage system necessary to manage the 100-year runoff; that is the runoff having a one percent probability of occurrence in any given year. Implementation of major drainage plans will reduce loss of life and major damage to the community and its infrastructure.
2. **Outfall System Planning:** Outfall system planning efforts identify detention, water quality and conveyance practices within a watershed that ultimately discharges to a receiving stream. Outfall system plans typically address storm drain improvements, stream crossing improvements, stream enlargement, stabilization, and floodplain preservation.
3. **Initial Drainage System Planning:** All local and regional planning should consider the initial drainage system to transport the runoff from 2-year to 5-year storms; these storms have a 50% to 20% respective probability of occurrence in any given year. The planner of an initial system must strive to minimize future drainage problems from these more frequently occurring storms.
4. **Water Quality and Environmental Design:** All planning efforts should address stormwater quality treatment requirements, opportunities for the development to mimic natural hydrology and preserve natural features, enhance habitat, and evaluate impacts of new facilities. When convened early in the planning and design process, a multi-disciplinary design team can help to ensure that the benefits to total urban systems are considered in the drainage planning effort.

#### Evolution of UDFCD Master Planning Program

“Initially, master planning was aimed at reducing flood potential in areas already developed. Now, much of our time is also spent on growth areas, working to prevent flood problems from ever occurring.”

—Ben Urbonas, UDFCD Master Planning Program Manager from 1976 to 2008.

5. **Long-term Maintenance and Operation:** Future operation and maintenance by private and public entities needs to be considered during the planning stages to ensure that the facility functions as designed over the long-term.

### 3.1.2 Master Planning

Drainage design does not lend itself to a piecemeal approach; therefore, master plans for drainage should be prepared on a prioritized basis. Such plans already cover most of the developed watersheds within in the UDFCD boundary. Additional plans will be developed for areas yet unplanned. In addition, existing master plans will be updated as needed to reflect conditions that change over time.

Initial steps include the planning of major drainage systems from the point of outfall, proceeding in an upstream direction. Major drainage systems, which are defined as servicing an area of at least 130 acres, are typically well defined and often dictate the design of the initial drainage system, including storm drains, detention facilities, and stormwater quality BMPs.

Master planning must be based upon potential future upstream development, taking into consideration both upstream and downstream existing and future regional publicly owned and operated (or controlled) detention and retention storage facilities. Assurances for construction and perpetual operation and maintenance of detention and retention facilities must be provided for the effects of the facilities to be considered in master planning. In the absence of such detention and retention facilities, the basis of design for both the initial and major systems is fully developed upstream conditions without storage.

Each municipality and county within UDFCD's boundary is responsible for master planning urban storm drainage facilities within its jurisdiction. UDFCD can help to coordinate efforts. Cooperation between governmental entities is needed to solve drainage problems, and joint city, county and UDFCD efforts are encouraged. Master planning is best accomplished on a systematic priority basis so that the most demanding problems, such as areas of rapid urbanization, are addressed first.

UDFCD has established a standard format for master plan reports and drawings so that a uniform planning approach and coordination of efforts can occur more easily. Master planning should be completed in adequate detail to provide a clear drainage framework for future development in a particular watershed. Generalized concepts based on rough hydrological analyses should not be used as master plans; a more rigorous analysis is necessary.

### 3.1.3 Floodplain Easements

A master plan should be prepared prior to development in a watershed. Where development occurs in a watershed in advance of a master plan, flood easements should be retained for the 100-year floodplain. If available the future conditions 100-year floodplain should be used for this purpose. Where an existing master plan recommends the preservation of a defined floodplain, every effort should be made to acquire and/or preserve an easement or property right (ownership) for such a floodplain.

On any floodplain, nature possesses an



**Photograph 1-2.** National Medal of Science winner, Dr. Gilbert White, recommended naturalistic floodplains because they save people from damages and are good for the economy and the environment.

intrinsic easement for intermittent occupancy by runoff waters. Humans can deny this easement only with difficulty. Encroachments upon, or unwise land modifications within this easement can adversely affect upstream and downstream flooding occurrences during nature's inevitable periodic occupancy of this easement. Floodplain regulations, therefore, must define natural easements and boundaries and must delineate floodplain and floodways that are consistent with the overall public interest.

### 3.1.4 Local and Regional Planning

Local and regional planning, whether performed under federal or state assistance programs or under completely local auspices, should consider and evaluate opportunities for multi-objective water resources management.

### 3.1.5 Development and Site Planning

All land development proposals should receive full site planning and engineering analyses. In this regard, professional consideration must be given to the criteria outlined in this manual. Development of an area without the provision of adequate drainage multiplies the cost to the public because the drainage problem must be corrected later, usually at public expense. Where flood hazards are involved, local planning boards should consider proposed land use so that it is compatible with the flood hazard risks involved with the property, and appropriate easements should be provided to preclude encroachment upon waterways or flood storage areas.

A development plan should consider broad goals such as:

- Drainage and flood control problem alleviation,
- Economic reasonableness,
- Broader regional development context,
- Environmental preservation and enhancement, considering water quality and stream stability,
- Social and recreational objectives.



**Photograph 1-3.** An urban storm drainage strategy should be a multi-objective and multi-means effort.

These goals have the potential to influence the type of drainage subsystem selected. Planning for drainage facilities should be related to the goals of the urban region, should be looked upon as a subsystem of the total urban system, and should not proceed independent of these considerations (Wright 1967).



### 3.1.6 Managing Runoff from Frequently Occurring Storms

Protecting and enhancing the water quality of streams is an important objective of drainage planning. Erosion control, maintaining stream stability, and reducing pollutant loading from stormwater runoff must be considered. Volume 3 of the USDCM provides criteria for stormwater runoff BMPs that help to reduce runoff volumes for frequently occurring storm events and provide treatment of the water quality capture volume (WQCV), which is based on the 80<sup>th</sup> percentile runoff-producing event.

The first step in managing runoff from frequently occurring storms is implementing runoff reductions

#### Common Stormwater Quality Terms and Concepts

**Best Management Practice (BMP):** A device, practice, or method for removing, reducing, retarding, or preventing targeted stormwater runoff constituents, pollutants, and contaminants from reaching receiving waters. (Some entities use the terms "Stormwater Control Measure" or "Stormwater Control.")

**Low Impact Development (LID):** LID is a comprehensive land planning and engineering design approach to managing stormwater runoff with the goal of mimicking the pre-development hydrologic regime. LID emphasizes conservation of natural features and use of engineered, on-site, small-scale hydrologic controls that infiltrate, filter, store, evaporate, and detain runoff close to its source.

**Minimizing Directly Connected Impervious Area (MDCIA):** MDCIA includes a variety of runoff reduction strategies based on reducing impervious areas and routing runoff from impervious surfaces over grassy areas to slow runoff and promote infiltration. MDCIA is recommended as a key technique for reducing runoff peaks and volumes for frequently-occurring storms following urbanization. MDCIA is a key component of LID.

**Green Infrastructure:** Planning and design of systems intended to benefit from the services and functions provided in the natural environment. In regard to wet weather management, and on a regional scale, preservation of riparian floodplains and channel stabilization that allows for vital habitat and wildlife passage through techniques similar to those found in nature, preserves ecological function and creates balance between built and natural environments. On an urban level, wet weather management practices that include infiltration, evapotranspiration, and reuse to help restore natural hydrology.

**Water Quality Capture Volume (WQCV):** This volume represents runoff from frequent storm events such as the 80th percentile runoff-producing event. The volume varies depending on local rainfall data. Within the UDFCD boundary, the WQCV is based on runoff from 0.6 inches of precipitation.

**Excess Urban Runoff Volume (EURV):** EURV represents the difference between the developed and pre-developed runoff volume for the range of storms that produce runoff (generally greater than the 2-year event for pervious land surfaces). The EURV is relatively constant for a given imperviousness over a wide range of storm events.

**Full Spectrum Detention:** This practice utilizes capture and slow release of the EURV. UDFCD has found this method better replicates historic peak discharges for the full range of storm events compared to multi-stage detention practices.

practices, also known as *minimizing directly connected impervious area* (MDCIA), which reduces the amount and connectivity of impervious surfaces in a development. This can be accomplished through a variety of techniques such as functional grading, wide and shallow surface flow sections, disconnection of hydrologic flow paths, and the use of bioretention and permeable pavements. The extent to which MDCIA and runoff reduction can be implemented on a development site is dependent on the site conditions (e.g., soil type, groundwater depth, depth to bedrock) and development type (e.g., new development, redevelopment, ultra urban, infill.). Opportunities for runoff reduction should be evaluated in each development. Once this step has been completed, then BMPs designed to treat the remaining WQCV can be implemented. An alternative to treating the WQCV is use of an integrated detention and water quality detention facility based on capture and treatment of the Excess Urban Runoff Volume (EURV). Design criteria for these facilities, described as full spectrum detention facilities, are provided in the *Storage* chapter.

### 3.1.7 Separation of Stormwater and Sanitary Flows

Sanitary sewage systems that overflow or bypass untreated sewage into surface streams are not permitted in Colorado. Drainage planning should prevent inflow to sanitary sewers resulting from street flow and channel flooding. In cases where sanitary sewers are flooded by urban storm runoff, engineers and planners should work together to correct these problems. Additionally, illegal connections of sanitary sewers to the storm drain system or conditions where storm drains intercept flows from leaking sanitary sewers must be corrected to protect public health.

## 3.2 Multiple-Objective Considerations

Planning for drainage facilities should be coordinated with planning for open space, recreation and transportation. By coordinating these efforts, new opportunities can be identified which can assist in the solution of drainage problems (Heaney, Pitt and Field 1999).

1. **Lower Drainage Costs.** Planning drainage works in conjunction with other urban needs results in more orderly development and lower costs for drainage and other facilities.
2. **Open Space.** Open space provides significant urban social and environmental benefits. Use of stabilized, natural streams is often less costly than constructing artificial channels. Combining the open space needs of a community with the major drainage system is a desirable combination of uses that reduces land costs and promotes riparian zone protection and establishment over time.
3. **Transportation.** Design and construction of new streets and highways should be fully integrated with drainage needs of the urban area for better streets and highways and better drainages and to avoid creation of flooding hazards. The location of borrow pits needed for road construction should be integrated with broad planning objectives, including storm runoff detention.
4. **Natural Channels.** Natural streams should be used in lieu of storm drains for stormwater runoff wherever practical. Preservation and protection of natural streams are encouraged; however, significant consideration must be given to their stability as the tributary area urbanizes.
5. **Channelization.** Natural streams within an urbanizing area are often deepened, straightened, lined, and sometimes put underground. A community loses a natural asset when this happens. Channelizing a natural waterway usually speeds up the flow, causing greater downstream flood peaks and higher drainage costs, and does nothing to enhance the environment. Natural streams within an urbanizing area require stabilization, not channelization.



6. **Channel Storage.** Streams having “slow-flow” characteristics, vegetated bottoms and sides, and wide water surfaces provide significant floodplain storage capacity. This storage is beneficial because it reduces downstream runoff peaks and provides an opportunity for groundwater recharge. Wetland channels, wide natural streams, and adjacent floodplains provide urban open space.



**Photograph 1-4.** Streams having “slow-flow” characteristics with vegetated bottoms and sides can provide many benefits.

7. **Major Runoff Capacity.** Streams and their residual floodplains should be capable of carrying the 100-year storm runoff, which can be expected to have a one percent chance of occurring in any given year.

8. **Maintenance and Maintenance Access.** Urban streams require both scheduled and unscheduled maintenance activities such as removal of sediment, debris and trash; mowing, and repair of hydraulic structures. Assured long term maintenance is essential, and it must be addressed during planning and design. UDFCD assists with drainage facility maintenance, provided that the facilities are designed and constructed in accordance with the UDFCD’s Maintenance Eligibility Guidelines. The most current version of these guidelines may be obtained from UDFCD’s website ([www.udfcd.org](http://www.udfcd.org)). Designers are strongly encouraged to adhere to the design criteria listed in the Maintenance Eligibility Guidelines. Waterways, detention facilities, and other drainage facilities must have permanent access for routine and major maintenance activities.

### 3.3 Avoiding Transfer of Problems

Planning and design of stormwater drainage systems should not be based on the premise that problems can be transferred from one location to another. Both intra-watershed and inter-watershed transfers

#### Multi-purpose Values of Urban Stream Corridors

“Urban stream corridors provide many critical functions in the life of a community. During storm events, they function as conveyance systems for storm runoff. Floodplain managers have a keen interest in making this function as reliable and safe as possible. But, urban stream corridors are much more. Their linear nature is well suited to trails and a variety of recreational activities. Human beings are naturally drawn to water and the natural environment. Moreover, Coloradoans seek an active outdoor lifestyle and value natural areas for beauty and the appreciation of wildlife. Urban streams also provide an immense ecological resource and are central to the natural processes that support the environment.

Thus, thoughtful treatment of these natural systems creates community assets that are important to local governments and developers as they plan new projects and especially to the future residents. Therefore, trails, recreational activities, floodplain, wetland, and riparian preservation are critical community values.”

—Bill DeGroot, UDFCD Floodplain Management Program Manager (1974- 2014)

should be avoided and appropriate assumptions should be made during master planning to avoid transfer of problems. Key principles include:

1. **Intra-Watershed Transfer:** Channel modifications that create unnecessary problems downstream should be avoided, both for the benefit of the public and to avoid damage to private parties. Problems to avoid include land and channel erosion and downstream sediment deposition, increase of runoff peaks, and debris transport, among others.
2. **Inter-Watershed Transfer:** Diversion of storm runoff from one watershed to another introduces significant legal and social problems and should be avoided unless specific and prudent reasons justify and dictate such a transfer and no measurable damages occur to the natural receiving water or urban systems or to the public.

### 3.4 Detention and Retention Storage

Stormwater runoff can be stored in detention basins and retention ponds. Such storage, when properly designed, constructed, and maintained with adequate assurances for the long-term, can reduce the peak flow drainage capacity required, thereby reducing the land area and expenditures required downstream. Retention ponds, both on and off-line, require a legal right to store water in Colorado. Consultation with the State Engineer's Office is needed in such cases.



**Photograph 1-5.** Retention ponds with permanent ponding have many benefits, including flood reduction, water quality and land values.

#### 3.4.1 Upstream Storage

Provide temporary storage of storm runoff close to the points of rainfall occurrence to the extent practical. Opportunities for storage include on-site detention basins and retention ponds, parking lots, ball fields, property line swales, parks, road embankments, and borrow pits. Wherever reasonably acceptable from a social standpoint, parks should be used for short-term detention of storm runoff. Such use may help justify park and greenbelt acquisition and expenditures. This "Blue-Green" concept was introduced in the 1960's (Jones 1967) and remains an effective strategy in drainage planning.

Parking lots create more runoff volume and higher runoff rates than natural conditions. Where practical, parking lots should be designed to provide temporary storage of runoff during infrequent events (e.g., 5-year or greater).

Due to the difficulty in quantifying the cumulative effects of very large numbers of small (i.e., on-site) detention/retention facilities (Malcomb 1982; Urbonas and Glidden 1983) and the challenge of assurance of their continued long-term performance or existence (Debo 1982; Prommersberger 1984), UDFCD recognizes only regional, publicly owned (or controlled) facilities in its floodplain management program.

### **3.4.2 Downstream Storage**

Detention and retention of storm runoff is desirable in slow-flow channels, in storage facilities located in the stream, in off-line facilities, and by using planned channel overflow ponding in park and greenbelt areas. Lengthening the time of concentration of storm runoff to a downstream point is an important goal of storm drainage and flood control strategies.

### **3.4.3 Reliance on Privately Controlled Facilities and Water Storage Reservoirs**

Privately controlled facilities cannot be used for flood mitigation purposes in master planning because their perpetuity cannot be reasonably guaranteed. Additionally, publicly owned water storage reservoirs (city, state, water district, irrigation company, etc.) should be assumed to be full for flood planning purposes and only the detention storage above the spillway crest considered in the determination of downstream flood peak flows. Exceptions may occur where legal agreements are in place ensuring flood storage in perpetuity.

### **3.4.4 Reliance on Embankments**

The detention of floodwaters behind embankments created by railroads, highways or roadways resulting from hydraulically undersized culverts or bridges should not be utilized for flood peak mitigation when determining the downstream flood peaks for channel capacity purposes unless such detention has been established in perpetuity through a legally binding agreement.

## **4.0 Technical Criteria**

### **4.1 Intended Use of Design Criteria**

Storm drainage planning and design should adhere to the criteria developed and presented in this manual. The design criteria presented herein represent current best engineering practice, and their use in the region is recommended. The criteria are not intended to be an ironclad set of rules that the planner and designer must follow; they are intended to establish guidelines, standards and methods for sound planning and design. UDFCD revises and updates the criteria as necessary to reflect advances in the field of urban drainage engineering and urban water resources management.

Governmental entities and engineers should utilize the USDCM in planning new facilities and in their reviews of proposed works by developers, private parties, and other governmental entities, including the Colorado Department of Transportation and other agencies of the state and federal governments.

### **4.2 Initial and Major Drainage Criteria**

Every urban area has two separate and distinct drainage systems, whether or not they are actually planned and designed. One is the initial system, and the other is the major system. Both systems must be planned and properly engineered to provide for orderly urban growth, reduce costs to future generations, and avoid loss of life and major property damage.

#### **4.2.1 Design Storm Return Periods for Initial and Major Drainage Systems**

Storm drainage planning and design should fully recognize the need for two separate and distinct storm drainage systems: the initial drainage system and the major drainage system. Recommended design storms for the initial and major drainage systems are specified in Table 1-1. Local governments should not be tempted to specify larger than necessary design runoff criteria for the initial drainage system

because of the direct impact on the cost of urban infrastructure.

Normally, the initial drainage system cannot economically carry major storm runoff, though the major drainage system can provide for the initial runoff. A well-planned major drainage system will reduce or eliminate the need for storm drain systems (Jones 1967). Systems consisting of underground pipes are a part of initial storm drainage systems.

**Table 1-1. Design storms and purposes of initial and major drainage systems**

<b>Drainage System</b>	<b>Design Storm</b>	<b>Purposes</b>
Initial Drainage System	2- to 5-year floods (depends on local criteria)	Reduce the frequency of street flooding and maintenance costs, provide protection against regularly recurring damage from storm runoff, help create an orderly urban system, and provide convenience to urban residents.
Major Drainage System	100-year flood (1% probability of occurrence for any given year)	Avoid major property damage and loss of life for the storm runoff expected to occur from an urbanized watershed.

There are many developed areas within the UDFCD boundary that predate and do not fully conform to the drainage standards in Table 1-1. Flooding problems experienced in such areas were a key reason for the original development of the USDCM. UDFCD recognizes that upgrading already developed areas to conform to all of the policies, criteria, and standards contained in the USDCM will be difficult, if not impractical to obtain, short of complete redevelopment or renewal. However, flood risk management techniques can be applied to these areas.

Strict application of the USDCM in the overall planning of new development is practical and economical; however, when planning drainage improvements and designating floodplains for developed areas, the use of the policies, criteria, and standards contained in the USDCM should be adjusted to provide for economical and environmentally sound solutions consistent with other goals of the area. Where the 100-year storm is not chosen for design purposes, the residual impact of the 100-year storm should be investigated and made known.

#### **4.2.2 Critical Facilities**

Drainage engineers and planners should consider that certain critical facilities may need a higher level of flood protection. For instance, hospitals, police, fire stations and emergency communication centers should be designed in a manner so that their functioning will not be compromised, even during a 100-year flood. The use of a 500-year flood level for such facilities may be justified (and required by State floodplain regulations) in many instances.

#### **4.2.3 Runoff Computations**

The determination of runoff magnitude should be made using the techniques described in the *Runoff* chapter.

The peak discharges determined by any method are approximations. Rarely will drainage works operate at the design discharge. In actual practice, flow will always be more or less, as the hydrograph rises and falls during a storm event. Thus, the engineer should not overemphasize the detailed accuracy and precision of computed discharges but should emphasize the design of practical and hydraulically balanced drainage infrastructure based on sound logic and engineering, as well as dependable hydrology.

The use of more than three significant figures for estimating peak discharges conveys a false sense of precision and should be avoided.

#### **Master Plan Hydrology**

Published peak flows should only be changed when it is clear either an error was made or a recalibration of the regional hydrologic model impacts the area of study and, in either case, when continued use of the published flows is not in the public's interest.

Because of the public's reliance on published peak flow estimates, these values should be changed only when it is clear either an error was made or a recalibration of the regional hydrologic model impacts the area of study and, in either case, when continued use of the published flows is not in the public's interest.

#### **4.2.4 Joint Probability Computations**

The depth of flow in the receiving stream must be taken into consideration for backwater computations for both the initial and major storm runoff. An analysis of the joint probability of occurrence may be warranted. FEMA recommends modeling a 10-year water surface in the receiving stream for a 100-year tributary discharge. HEC-22 also provides guidance based on the ratio of main stream watershed area to that of the tributary stream.

#### **4.2.5 Open Channels for Major Drainage**

Open channels for transporting major storm runoff are more desirable than underground conduits, and use of such is encouraged. Open conveyance planning and design objectives are often best met by using naturalized streams (as described in the *Open Channels* chapter), which characteristically have slower velocities and large width-to-depth ratios. Additional benefits can be obtained by incorporating parks and greenbelts with the naturalized stream layout. Use of naturalized streams (and other storm runoff features) should be considered in the early planning stages of a new development.

When evaluating existing natural water courses (perennial, intermittent and ephemeral), straightening, fill placement, and other alterations should be minimized and carefully evaluated. Such actions tend to reduce flood storage and increase the velocity to the detriment of those downstream of and adjacent to the channel work. Effort should be made to reduce flood peaks and control erosion so that the natural channel regime is preserved as much as practical. Some type of structural stream stabilization is almost always necessary to stabilize the stream against increased flows associated with urbanization. For example, grade control structures and structural protection at the stream toe and on the outer banks at bends are normally required. Riparian buffer zones can be used to accommodate future meandering and bank sloughing, at least in part.

#### **4.3 Use of Streets**

Streets are a significant component of the urban drainage system, and use of streets for storm runoff should be made within reasonable limits, recognizing that the primary purpose of streets is for traffic. Reasonable limits of the use of streets for conveyance of storm runoff should be governed by design criteria summarized in Table 1-2 for initial storm runoff, Table 1-3 for major storm runoff and Table 1-4 for allowable maximum cross-street flow for initial and major design storm runoff. These criteria are

consistent with the intent that major storm runoff will be removed from public streets at frequent and regular intervals and routed into streams, as well as the recognition that runoff tends to follow streets and roadways; therefore, streets and roadways may be aligned to provide a specific runoff conveyance function.

**Table 1-2. Reasonable use of streets for initial storm runoff in terms of pavement encroachment**

Street Classification	Maximum Encroachment
Local	No curb overtopping. Flow may spread to crown of street.
Collector	No curb overtopping. Flow spread must leave at least one lane free of water.
Arterial	No curb overtopping. Flow spread must leave at least one lane free of water in each direction but should not flood more than two lanes in each direction.
Freeway	No encroachment is allowed on any traffic lanes.

**Table 1-3. Major storm maximum street ponding depth**

Street Classification	Maximum Ponding Depth
Local and Collector	Residential dwellings should be no less than 12 inches above the 100-year flood at the ground line or lowest water entry of a building. The depth of water over the gutter flow line should not exceed 12 inches for local and collector streets.
Arterial and Freeway	Residential dwellings should be no less than 12 inches above the 100-year flood at the ground line or lowest water entry of a building. The depth of water should not exceed the street crown to allow operation of emergency vehicles. The depth of water over the gutter flow line should not exceed 12 inches.

**Table 1-4. Maximum allowable cross-street flows**

Street Classification	Initial Design Runoff	Major Design Runoff
Local	6 inches of depth in cross pan	12 inches of depth above gutter flow line.
Collector	Where cross pans allowed, depth of flow should not exceed 6 inches	12 inches of depth above gutter flow line.
Arterial/Freeway	None	No cross flow. 12 inches of maximum depth at upstream gutter or roadway edge

Initial and major drainage planning should go hand-in-hand. When maximum allowable street encroachment will be exceeded, a storm drain system based on the initial storm should be planned. Development of a major drainage system that can also drain the initial runoff from the streets is encouraged; this enables the storm drain system to commence further downstream.

Other design criteria for use of streets include:

- An arterial street crossing will generally require a storm drain system.
- Bubblers (inverted siphons which convey flows beneath roadways) are discouraged because of plugging with sediment and difficulty in maintaining them. Additionally, these serve as a breeding ground for bacteria and mosquitos.
- Collector streets should have cross pans only at infrequent locations as specified by the governing entity and in accordance with good traffic engineering practices.
- The local street criteria for overtopping also apply to any private access road that serves commercial areas or more than one residence, for emergency access and safety reasons.
- Drainage design objectives for streets should include reducing street repair and maintenance costs, minimizing nuisance to the public, and minimizing frequent disruption of traffic flow.

#### **4.4 Use of Irrigation Ditches**

Use of irrigation ditches for collection and transport of either initial or major storm runoff should be prohibited unless specifically provided in a UDFCD master plan or approved by UDFCD and the ditch owner, following adequate hydraulic engineering analysis that demonstrates such use is without unreasonable hazard.

Irrigation ditches are typically characterized by flat slopes and limited carrying capacity. Experience and hydraulic calculations demonstrate that these physical limitations generally preclude use of ditches as an outfall point for the initial storm drainage system. Exceptions to the rule can occur when the capacity of the irrigation ditch is adequate to carry the normal ditch flow plus the initial storm runoff with adequate freeboard to avoid creating a hazard to those below the ditch. In such cases, written approval must be obtained from the ditch owner stating that the owner understands the physical and legal (i.e., liability) consequences of accepting such runoff.

Irrigation ditches are not suitable as an outfall for the major storm runoff. Without major reworking of irrigation ditches to provide major carrying capacity without undue hazard to those downstream or below the ditch, the ditches are almost always totally inadequate for such a use and should not be used as an outfall. Moreover, because ditches are normally privately owned, one cannot assume the perpetual existence or function of a ditch.

Other irrigation ditch-related considerations include:

- Land planners downhill from a ditch should ignore the effects of the ditch in hydrologic calculations, but should also plan for continued ditch seepage.
- Irrigation ditches are sometimes abandoned in urban areas after the agricultural land is no longer farmed. Provisions must be made for a ditch's perpetuation, defined as continued operation,



capacity, and serviceability, prior to its being chosen and used as an outfall for urban drainage.

## 4.5 Water Quality Treatment

Stormwater quality BMPs are designed based on either the Water Quality Capture Volume (WQCV) or the Excess Urban Runoff Volume (EURV):

- **WQCV:** The WQCV, as described in detail in Volume 3 of the USDCM, corresponds to approximately the 80th percentile runoff event and is used in BMPs designed for water quality purposes only. It is appropriate to size BMPs for the entire area tributary to the BMP. The release rate for the WQCV varies based on the type of BMP.
- **EURV:** The EURV represents the difference between the developed and pre-developed runoff volume for the range of storms that produce runoff (generally greater than the 2-year event from pervious land surfaces). The EURV is relatively constant for a given imperviousness over a wide range of storm events. The EURV is a greater volume than the WQCV and is detained over the minimum time necessary to allow for the recommended drain time of the WQCV, and is used to better replicate peak discharge in receiving waters for runoff events exceeding the WQCV. The EURV is associated with Full Spectrum Detention, a simplified sizing method for both water quality and flood control detention. EURV calculation procedures are provided in the *Storage* Chapter.

## 4.6 Maintenance of Storage and Water Quality Facilities

Long-term maintenance provisions must be arranged for storage and water quality facilities. Maintenance of detention or retention facilities includes the removal of debris, excessive vegetation from the embankment, and sediment. Maintenance requirements for water quality facilities (BMPs) vary, depending on the BMP type, as described in Chapter 6, Volume 3 of the USDCM. Without maintenance, detention, retention, and water quality facilities will become unsightly social liabilities and eventually become ineffective for their intended functions.

# 5.0 Floodplain Management

## 5.1 Purpose

Governmental entities within the UDFCD area should continue to implement floodplain management programs. Floodplain management includes comprehensive criteria designed to encourage, where necessary, the adoption of permanent state or local measures which will lessen exposure of life, property and facilities to flood losses, improve long-range land management and use of flood-prone areas, and inhibit, to the maximum extent feasible, unplanned future development in such areas.

### Floodplain Management

“Preventing new flood damage potential is not only a critical function of any total flood control program, it is typically the surest, most cost-effective way to reduce total annual losses from flooding. Prevention requires adhering to a well-documented, well-understood drainage philosophy that encourages utilization of non-structural methods of flood damage mitigation. Sensible land use regulations coupled with defined floodplains and drainage master plans keep new flood damage potential from being introduced into the 100-year floodplains.”—Bill DeGroot, UDFCD Floodplain Management Program Manager (1974 to 2014)



## 5.2 Goals

Floodplain management includes these two primary goals:

1. **Reduce the vulnerability of residents to the danger and damage of floods.** The dangers of flooding include threats to life, safety, public health, and mental well-being, as well as damage to properties and infrastructure and disruption of the economy. Protection from these hazards should be provided, by whatever measures are suitable, for floods having a one percent recurrence probability in any given year (100-year floods), at a minimum, based on projected build-out in the watershed. Protection from the effects of greater, less frequent flooding is also needed for critical facilities where such flooding would cause service interruptions or unacceptable damages.
2. **Preserve and enhance the natural values of the floodplain.** Natural floodplains serve society by providing floodwater storage, groundwater recharge, water quality enhancement, passive recreation, and habitat for plants and animals. Many floodplains also have cultural and historical significance. It is in the public's interest to avoid development that destroys these values or, in instances where the public good requires development, to ensure that measures are taken to mitigate the floodplain loss through replacement of floodplain functions or other means.

These two goals are achievable through coordinated floodplain management and drainage planning conducted in a coordinated manner by local governments and other entities.

## 5.3 National Flood Insurance Program

Flood insurance should be integral part of a strategy to manage flood losses. The cities and counties in the UDFCD area are encouraged to continue to participate in the National Flood Insurance Program (NFIP) set forth in the NFIA of 1968, as amended. A prerequisite for participation is the adoption of a floodplain management program by the local government that, where necessary, includes adoption of permanent state or local regulatory measures that will lessen the exposure of property and facilities to flood losses. Property owners should be encouraged to buy flood insurance, even outside the designated floodplain, to protect against local flooding where such potential exists.

## 5.4 Floodplain Management

The objectives of floodplain management are to:

1. Adopt effective floodplain regulations.
2. Improve local land use practices, programs, and regulations in flood-prone areas.
3. Provide a balanced program of measures to reduce losses from flooding.
4. Reduce the need for reliance on local and federal disaster relief programs.
5. Minimize adverse water quality impacts.
6. Foster the creation/preservation of greenbelts, with associated societal, water quality, wildlife and other ecological benefits, in urban areas.

The most successful and sustainable way to accomplish all of the above listed objectives is do so while promoting the natural and beneficial uses of the floodplain. The natural and beneficial uses of the floodplain hold political, social, and economic value. Although hydrologic data are critical to the development of a floodplain management program, a successful program is largely dependent on a series of policy, planning, and design decisions. These area-wide decisions provide the setting for floodplain

usage and, when combined with hydrologic considerations and augmented by administrative and other implementation devices, constitute a floodplain management program. The program must give high priority to both flood danger and public programs, such as urban renewal, open space, etc. See the Floodplain Preservation Brochure available at [www.udfcd.org](http://www.udfcd.org) for additional discussion and good examples of developments designed and constructed with value placed on the natural and beneficial functions of the floodplain.

“Floods are acts of God, but flood losses are largely acts of man.”

–Gilbert White, June 1945

## 5.5 Floodplain Filling

While floodplain management allows some utilization of the flood fringe (i.e., areas outside of the formal floodway), the planner and engineer should proceed cautiously when planning facilities on lands below the expected elevation of the 100-year flood. Flood peaks from urbanized watersheds are high and short-lived, which makes storage in the flood fringe important and effective. Filling the flood fringe tends to increase downstream peaks.

## 5.6 New Development

When deciding whether to 1) construct a major flood control project to enable new development or 2) maintain an open area within an urban floodplain, the following factors should be considered:

- Relative costs of the respective alternatives (not only financial, but also non-financial economic costs such as opportunities foregone).
- Opportunities for flood proofing and other measures in relation to the extent of flood hazard.
- Availability of land in non-floodprone areas for needed development.
- Location of the high flood hazard areas, namely, defined floodways.
- Potential adverse effect on others in or adjacent to the floodplain.
- The fact that floods larger than the design flood can and will occur (i.e., some level of risk exposure will still exist, even with well-designed facilities).

## 5.7 Floodplain Management Strategies and Tools

FEMA has developed a variety of floodplain management strategies and tools, as summarized in Table 1-5. Other strategies and tools may also be used.

**Table 1-5. Floodplain management strategies and tools**

<b>Strategy</b>	<b>Brief Description</b>
Reduce Exposure to Floods	Reduce exposure to floods and disruptions by employing floodplain regulations and local regulations. The latter includes zoning, subdivision regulations, building codes, sanitary and well codes, and disclosure to property buyers.
Development Policies	Development policies that include design and location of utility services, land acquisition, redevelopment, and permanent evacuation (purchase of properties).
Disaster Preparedness	Disaster preparedness is an important tool for safeguarding lives and property, and disaster assistance will reduce the impact to citizens from flooding.
Flood Proofing	Flood proofing of buildings is a technique that is wise and prudent where existing buildings are subject to flooding. Flood proofing can help a proposed project achieve a better benefit-cost ratio.
Flood Forecasting	Flood forecasting and early warning systems are important means to reduce flood losses, safeguard health, protect against loss of life and generally provide an opportunity for people to prepare for a flood event before it strikes.
Flood Modification	The use of methods to modify the severity of the flood is a floodplain management tool. These include regional detention, channelization, minimizing directly connected impervious area, and on-site detention.
Modification of Flood Impacts	The impact of flooding can be mitigated (or modified) though the education, flood insurance, tax adjustments, emergency measures, and a good post-flood recovery plan that can be initiated immediately following a flood.

## **6.0 Implementation of Urban Storm Drainage Criteria**

### **6.1 Adoption and Use of the USDCM and Master Plans**

The USDCM should be adopted and used by local governments operating within the UDFCD boundary, as a resource that:

1. Gives direction to public entity efforts to guide private decisions.
2. Gives direction to public entity efforts to regulate private decisions.
3. Provides a framework for a public entity when it seeks to guide other public entities.
4. Provides a framework to assist in coordinating a range of public and private activities.
5. Provides direction for development of master plans and designs and for implementation of drainage facilities.

Drainage master plans should be completed following the criteria in the USDCM and be adopted and implemented by all governmental entities within the master plan boundaries.

### **6.2 Governmental Participation**

Each level of government must participate if a drainage program is to be successful.

### **6.3 Amendments to Criteria**

Problems in urban drainage administration encountered by any governmental entity should be reviewed by UDFCD to determine if equity or public interests indicate a need for drainage policy, practice, or procedural amendments. UDFCD should continually review the needs of the region in regard to urban runoff criteria and should recommend changes as necessary to the USDCM.

### **6.4 Financing Drainage Improvements**

Financing storm drainage improvements is fundamentally the responsibility of the affected property owners (both the persons directly affected by the water and the person from whose land the water flows) as well as the local government. Every effort should be made to keep the cost of drainage solutions reasonable. This will involve careful balancing of storage and conveyance costs and the integration of drainage with other activities such as open space and transportation efforts. Funding must be established, and budgets should be prepared to assure proper maintenance of all new drainage and storage facilities.

## 7.0 References

- Debo, T. 1982. Detention Ordinances—Solving or Causing Problems? In *Stormwater Detention Facilities*, ed. William DeGroot, 332-341. New York: ASCE.
- Federal Emergency Management Agency. 1995. A Unified National Program for Floodplain Management. Washington, D.C.: FEMA.
- Heaney, J.P., R. Pitt, and R. Field. 1999. *Innovative Urban Wet-Weather Flow Management Systems*. Cincinnati, OH: USEPA.
- Jones, D.E. 1967. Urban Hydrology—A Redirection. *Civil Engineering*, 37(8):58-62.
- Malcomb, H.R. 1982. Some Detention Design Ideas. In *Stormwater Detention Facilities*, ed. William DeGroot, 138-145. New York: ASCE.
- Prince George's County, Maryland. 1999. Low-Impact Development Design Strategies—An Integrated Design Approach. Largo, MD: Prince George's County, Maryland, Department of Environmental Resources.
- Prommersberger, B. 1984. Implementation of Stormwater Detention Policies in the Denver Metropolitan Area. *Flood Hazard News*, 14(1)1, 10-11.
- Urban Drainage and Flood Control District, 2007. Resolution No. 10, Series of 2007, District Levee Policy.
- Urbonas, B. and M.W. Glidden. 1983. Potential Effectiveness of Detention Policies. *Flood Hazard News*, 13(1) 1, 9-11.
- White, G.F. 1945. *Human Adjustments to Floods; A Geographical Approach to the Flood Problem in the United States*. Research Paper No. 29. Chicago, IL: University of Chicago, Department of Geography.
- Wright, K.R. 1967. Harvard Gulch Flood Control Project. *Journal of the Irrigation and Drainage Division*, 91(1):15-32.
- Wright-McLaughlin Engineers. 1969. *Urban Storm Drainage Criteria Manual*. Prepared for the Denver Regional Council of Governments. Denver, CO: Urban Drainage and Flood Control District.

# Chapter 2

## Drainage Law

### Contents

<b>1.0</b>	<b>Summary of Current General Principles of Drainage and Flood Control Law</b> .....	<b>1</b>
1.1	Introduction.....	1
1.2	Legal Principles.....	1
<b>2.0</b>	<b>General Principles of Drainage Law</b> .....	<b>4</b>
2.1	Private Liability.....	4
2.1.1	Common Enemy Rule.....	5
2.1.2	Civil Law Rule.....	5
2.1.3	Reasonable Use Rule .....	5
2.2	Municipal Liability.....	6
2.2.1	Planning Drainage Improvements.....	6
2.2.2	Construction, Maintenance, and Repair of Drainage Improvements .....	7
2.2.3	Summary.....	8
2.3	Municipal Liability for Acts of Others.....	9
2.3.1	Acts or Omissions of Municipal Officers, Agents, or Employees .....	9
2.3.2	Municipal Liability for Acts of Developers .....	9
2.4	Personal Liability of Municipal Officers, Agents, and Employees .....	10
<b>3.0</b>	<b>Drainage Improvements by a Local Government</b> .....	<b>11</b>
3.1	Constitutional Power .....	11
3.2	Statutory Power .....	11
3.2.1	Municipal Statutes.....	11
3.2.2	County Statutes .....	11
3.2.3	State Statutes .....	12
3.2.4	Urban Drainage and Flood Control Act .....	14
3.2.5	Drainage Authority .....	14
<b>4.0</b>	<b>Financing Drainage Improvements</b> .....	<b>15</b>
4.1	Capital Improvement.....	15
4.2	Local Improvement .....	15
4.3	Special Improvement .....	15
4.4	Service Charge .....	16
4.5	Developer’s Cost.....	17
4.6	The Taxpayers Bill of Rights, Article X, Section 20, Colorado Constitution .....	20
4.7	Water Activities—Enterprise Statute 37-45.1-101 C.R.S. ....	22
<b>5.0</b>	<b>Floodplain Management</b> .....	<b>22</b>
5.1	Floodplain Regulations .....	23
5.1.1	Constitutional Considerations .....	23
5.1.2	Statutory Grants of Power.....	23
5.1.3	Court Review of Floodplain Regulations .....	24
5.2	Flood Insurance .....	26
5.3	Flood Warning Systems and Notification .....	27
<b>6.0</b>	<b>Special Matters</b> .....	<b>27</b>
6.1	Irrigation Ditches .....	27
6.2	Dams and Detention Facilities .....	28

6.3	Stormwater Management and Water Law.....	30
6.4	Professional Responsibility.....	31
6.5	Professional Liability.....	32
6.6	Miscellaneous Issues.....	33
<b>7.0</b>	<b>Conclusion .....</b>	<b>35</b>

## 1.0 Summary of Current General Principles of Drainage and Flood Control Law

### 1.1 Introduction

Drainage law not only has its basis in law made by the courts and the legislature but also relies to a large extent on the drainage facts that exist in each case. Therefore, a party with the most reliable facts and information will have a distinct advantage in court. Similarly, drainage engineering and design revolves around drainage law as well as the natural law of gravity.



**Photograph 2-1.** Preserving a natural floodplain, including wetland areas, and using this area for flood control and conveyance, represents sound engineering in concert with established Colorado drainage law.

This chapter deals with the general principles of drainage law along with local government drainage actions, financing, floodplain management, and special matters. This chapter is meant to provide an outline of the general principles of Colorado drainage law for the engineer and agency official. It is not meant to serve as a substitute for a lawyer's opinions, though this chapter may be of interest to practicing attorneys. Also, throughout this chapter cases from other jurisdictions are cited. Although they are from courts located in other states, they are cited since they provide the reasoning and law that most likely would be implemented by courts in the State of Colorado.

In using this chapter of the Urban Storm Drainage Criteria Manual (USDCM), the reader should be familiar with the entire USDCM and should pay particular attention to the *Policy* and *Planning* chapters. In the *Policy* chapter, 12 principles have been stated, with which the reader of this chapter should be familiar. Similarly, the following legal principles are summarized below for ready reference.

### 1.2 Legal Principles

1. The owner of upstream property possesses a natural easement on land downstream for drainage of surface water flowing in its natural course. The upstream property owner may alter drainage conditions so long as the water is not sent down in a manner or quantity to do more harm to the downstream land than formerly. Bittersweet Farms, Inc. v. Zimbelman, 976 P.2d 326 (Colo. App. 1998).
2. On July 1, 2003 the Colorado Legislature substantially changed the law in regard to the liability of governmental entities and the drainage, flood control, and stormwater facilities that they own or maintain. Governmental entities on and after July 1, 2003 have complete governmental immunity in regard to the drainage, flood control, and stormwater facilities that they own or maintain. The law in Colorado however did not change in regard to other facilities that a governmental entity owns and operates. In regard to those other facilities, a governmental entity's liability is determined as if it is a private party. However, the amount of its liability is limited by the Colorado Governmental Immunity Act.
3. A natural watercourse may be used as a conduit or outlet for the drainage of lands, at least where the augmented flow will not tax the stream beyond its capacity and cause flooding of adjacent lands. Ambrosio v. Pearl-Mack Construction Co., 351 P.2d 803 (Colo. 1960).



4. Ditch corporations that own ditches owe a duty to those property owners through which their ditches pass to maintain their ditches using ordinary care so as to prevent damage to adjoining real property. Oliver v. Amity Mut. Irrigation Co., 994 P.2d 495 (Colo. App. 1999). Further, ditch owners are not required under the law to accept stormwater runoff that is result of development that occurs after the ditch was constructed. The ditch owner would have a legal claim based upon trespass as well as a claim based upon the fact that the ditch is not a natural drainage and most likely the increased flows will be deposited into the ditch in a manner or quantity to do more harm than formerly. Hankins v. Borland, 431 P.2d 1007 (Colo. 1967).
  5. Construction or enlargement of jurisdictional dams or reservoirs is subject to approval by the Colorado State Engineer's Office, which, depending on the size of the dam and the hazard classification, may include requirements for spillways to pass up to the Extreme Storm Precipitation (ESP) event<sup>1</sup>. A "jurisdictional dam" is defined as a dam that impounds water above the elevation of the natural surface of the ground creating a reservoir that meets one of the following conditions:
    - i. Has a capacity of more than 100 acre-feet;
    - ii. Has a surface area exceeding 20 acres at the high waterline; or
    - iii. Exceeds 10 feet in height measured vertically from the elevation of the lowest point of the natural surface of the ground where that point occurs along the longitudinal centerline of the dam up to the flow line crest of the emergency spillway of the dam.
- Rules 4 & 5 of the Department of Natural Resources, Division of Water Resources, Office of the State Engineer, Rules and Regulations for Dam Safety and Dam Construction, 2-CCR 402-1, Effective Date: January 1, 2007.
6. The boundaries of the floodplain should be accurately determined and based on a reasonable standard. Mallett v. Mamarooneck, 125 N.E. 2d 875 (N.Y. 1955).
  7. Adoption of a floodplain regulation to regulate flood-prone areas is a valid exercise of police power and is not a taking as long as the regulation does not go beyond protection of the public's health, safety, morals, and welfare. Hermanson v. Board of County Commissioners of Fremont, 595 P.2d 694 (Colo. App. 1979).
  8. The adoption by a municipality of floodplain ordinances to regulate flood-prone areas is a valid exercise of police power and is not a taking. Morrison v. City of Aurora, 745 P.2d 1042 (Colo. App. 1987).
  9. A zoning ordinance is not unconstitutional because it prohibits a landowner from using or developing his land in the most profitable manner. It is not required that a landowner be permitted to make the best, maximum or most profitable use of his property. Baum v. City and County of Denver, 363 P.2d 688 (Colo. 1961) and Sundheim v. Board of County Commissioners of Douglas County, 904 P.2d 1337 (Colo. App. 1995).
  10. The Colorado Governmental Immunity Act (CGIA), in addition to providing complete immunity to

---

<sup>1</sup> The ESP event represents the greatest depth of precipitation for a given duration that is physically possible over a drainage basin through the application of modern meteorological techniques, based on Colorado extreme storm data approved by the State Engineer.

governmental entities for the drainage, flood control, and stormwater facilities that they own or maintain, also does not require a governmental entity to upgrade, modernize, modify, or improve the design or construction of a facility, including but not limited to the drainage, flood control and stormwater facilities that it owns or maintains. This same protection does not include private parties.

11. A “dangerous condition” constitutes an unreasonable risk to the health or safety of the public, which is known to exist or which in the exercise of reasonable care should have been known to exist and which condition is proximately caused by the negligent act or omission of the public entity in constructing or maintaining such facility. 24-10-103 (1.3) C.R.S. However, a dangerous condition shall not exist solely because the design of any facility is inadequate. Again, this protection does not extend to private parties.
12. Under the CGIA, a governmental entity is not protected by immunity in regard to the operation and maintenance of any “public water facility” or “sanitation facility.” 24-10-106 (f) C.R.S.
13. However, under the CGIA, a “public water facility” does not include a “public sanitation facility;” a natural watercourse even if dammed, channelized, or used for transporting domestic water supplies; a drainage, borrow, or irrigation ditch even if dammed, channelized, or containing stormwater runoff or discharge; or a curb and gutter system. 24-10103 (5.7) C.R.S.
14. Also, under the CGIA, a “public sanitation facility” does not include a “public water facility;” a natural watercourse even if dammed, channelized, or containing stormwater runoff, discharge from a storm sewer; a drainage, borrow, or irrigation ditch even if the ditch contains stormwater runoff or discharge from storm sewers; a curb and gutter system or other drainage, flood control, and stormwater facilities. 24-10103 (5.5) C.R.S. Therefore, a public entity will be immune from liability in regard to all drainage and flood control facilities that it designs, constructs and maintains. Again, this protection does not extend to private parties.
15. Under the CGIA, a public entity will not be liable for its failure to upgrade, modernize, modify, or improve the design or construction of a drainage or flood control facility or any other facility that it owns or maintains whether it knows of a deficiency or not or whether it is a dangerous condition or not. 24-10-103 (2.5) C.R.S. The Colorado Legislature in enacting this law found that governmental entities “. . . provide essential public services and functions and the increased legal liability from not having this type of statutory protection poses the danger of disrupting or making prohibitively expensive the provision of such services and functions.”
16. The CGIA has not been challenged in court since its adoption in 2003 although courts have considered whether its application was meant by the Colorado Legislature to be retroactive. Therefore, it is uncertain if the CGIA would withstand a legal challenge. Regardless, governmental entities should, to the best of their ability, attempt to construct, operate, and maintain the drainage, flood control, and stormwater facilities that they own to the same standard that private parties are required to meet.
17. CGIA does not protect a public entity from a claim based upon inverse condemnation. Inverse condemnation is defined as the taking of private property for a public or private use, without compensation, by a governmental or public entity which has refused to exercise its eminent domain power.
18. In imposing conditions upon the granting of land-use approvals, no local government shall require an owner of private property to dedicate real property to the public or pay money to a public entity in an amount that is determined on an individual and discretionary basis, unless there is an essential nexus between the dedication or payment and a legitimate local government interest and the dedication or

payment is roughly proportional both in nature and extent to the impact of the proposed use or development of such property. This law does not apply to any legislatively formulated assessment, fee, or charge that is imposed on a broad class of property owners by a local government. 29-20-203 C.R.S.

19. Public entities that own dams or reservoirs are not subject to strict liability for damages caused by water escaping from their dams or reservoirs. Further, those public entities have no duty to ensure that waters released from an upstream reservoir because of a dam failure would be contained by their facilities or would bypass those facilities without augmentation. Kane v. Town of Estes Park, 786 P.2d 412 (Colo. 1990).
20. A professional engineer is required not only to serve the interests of his or her employer/client but is also required, as his or her primary obligation, to protect the safety, health, property, and welfare of the public. Rule I 2. of The Colorado Rules of Professional Conduct of the State Board of Registration for Professional Engineers and Professional Land Surveyors.
21. Where a municipality imposes a special fee upon owners of property for purposes of providing a service and where the fee is reasonably designed to defray the cost of the service provided by the municipality, such a fee is a valid form of governmental charge within the legislative authority of the municipality. Bloom v. City of Fort Collins, 784 P.2d 304 (Colo. 1989).

## 2.0 General Principles of Drainage Law

Very little is gained if the same act which dries up one tract of land renders the adjoining tract twice as difficult to redeem. Livingston v. McDonald, 21 Iowa 160, 170 (1866).

### 2.1 Private Liability

Traditionally, courts have analyzed the legal relations between parties in drainage matters in terms of such property concepts as natural easements, rights, privileges, and servitudes but have based liability for interfering with surface waters on tort principles. See Kenyon and McClure *Interferences With Surface Waters*, 24 Minn. L. Rev. 891 (1940). Drainage and flood control problems attendant with increased urbanization, the trend in tort law toward shifting the burden of a loss to the best risk-bearer, and complete or partial reinstatement of governmental immunity by the legislature will continue to change the traditional rules that have governed legal relations between parties in drainage matters. These changes are reflected in the three basic rules relating to drainage of surface waters that have been applied over a period of time in the United States: the common enemy rule, the civil law rule (later to be called a “modified civil law rule”), and the reasonable use rule.

### 2.1.1 Common Enemy Rule

Under the common enemy rule, which is also referred to as the common law rule, surface water is regarded as a common enemy, which each property owner may fight off or control as he or she will or is able, either by retention, diversion, repulsion, or altered transmission. Thus, there is no cause of action even if some injury occurs. All jurisdictions originally following this harsh rule have either modified the rule or adopted the civil law rule or reasonable use rule. 5 *Water and Water Rights*, §§450.6, 451.2 (R.E. Clark ed. 1972).

### 2.1.2 Civil Law Rule

The civil law rule, or natural flow rule, places a natural easement or servitude upon the lower land for the drainage of surface water in its natural course, and the natural flow of the water cannot be obstructed by the servient owner to the detriment of the dominant owner. 5 *Water and Water Rights*, §452.2A (R.E. Clark ed. 1972). Most states following this rule, including Colorado, have modified the rule. Under the modified rule, the owner of upper lands has an easement over lower lands for drainage of surface waters, and natural drainage conditions can be altered by an upper proprietor provided the water is not sent down in a manner or quantity to do more harm than formerly. *Hankins v. Borland*, 163 Colo. 575, 431 P.2d 1007 (1967); *H. Gordon Howard v. Cactus Hill Ranch Company*, 529 P.2d 660 (1974); *Hoff v. Ehrlich*, 511 P.2d 523 (1973); but see *Ambrosio v. Perl-Mack Construction Company*, 143 Colo. 49, 351 P.2d 803 (1960) and *Bittersweet Farms, Inc. v. Zimelman*, 976 P.2d 326 (Colo. App. 1998).

### 2.1.3 Reasonable Use Rule

Under the reasonable use rule, each property owner can legally make reasonable use of his land, even though the flow of surface waters is altered thereby and causes some harm to others. However, liability attaches when the harmful interference with the flow of surface water is “unreasonable.” Whether a landowner’s use is unreasonable is determined by a nuisance-type balancing test. The analysis involves three inquiries:

1. Was there reasonable necessity for the actor to alter the drainage to make use of his or her land?
2. Was the alteration done in a reasonable manner?
3. Does the utility of the actor’s conduct reasonably outweigh the gravity of harm to others?

*Restatement Torts*, §§822-831, 833 (1939); *Restatement (Second) Torts*, §158, Illustration 5. Alaska, Hawaii, Kentucky, Massachusetts, Minnesota, New Hampshire, New Jersey, North Carolina, North Dakota, Ohio and Utah have adopted this rule. Some states have restricted their application of the rule to urban areas (South Dakota and Texas). In *Pendegast v. Aiken*, 236 S.E. 2d 787 (1977), the North Carolina Supreme Court traces the common law rule to the civil law rule to adoption by that court of the reasonable use rule, starting at page 793:

It is no longer simply a matter of balancing the interests of individual landowners; the interests of society must be considered. On the whole the rigid solutions offered by the common enemy and civil law rules no longer provide an adequate vehicle by which drainage problems may be properly resolved.

## 2.2 Municipal Liability

A municipality is generally treated like a private party in regard to the determination of negligence in matters other than drainage and flood control. Harbison v. City of Hillsboro, 103 Ore. 257, 204 P. 613, 618 (1922); City of Golden v. Western Lumber and Pole Company, 60 Colo. 382, 154 P. 95 (1916) (a municipality undertaking a public improvement is liable like an individual for damage resulting from negligence or an omission of duty); City of Denver v. Rhodes, 9 Colo. 554, 13 P. 729 (1887). With regard to drainage and flood control improvements, however, the Colorado legislature has legislatively changed the law to provide for immunity of municipalities and other public entities. Since 2003, public entities have been immune from liability in regard to the construction and maintenance of natural watercourses even if dammed, channelized, or containing stormwater runoff, discharge from a storm sewer; a drainage, borrow, or irrigation ditch even if the ditch contains stormwater runoff or discharge from storm sewers; a curb and gutter system or other drainage, flood control, and stormwater facilities. Although these statutes seem to protect public entities from lawsuits in regard to damage to citizens from drainage and flood control facilities that were negligently designed, constructed, or maintained, the prudent approach in designing, constructing, and maintaining these facilities is to assume such immunity is not available to a public entity. In that way, public entities will always be protecting the best interests of its citizens. However, governmental immunity does not protect a public entity from a claim made in inverse condemnation for the taking of property rights without compensation.

In the case of Jorgenson v. City of Aurora, 767 P.2d 756 (Colo. App. 1988), the Colorado Court of Appeals held that given the constitutional genesis of a claim for inverse condemnation, and considering the nature of the right upon which this action is founded, a claim in inverse condemnation is not subject to the Governmental Immunity Act.

It is becoming more and more common for private developers to design, construct, and maintain drainage and flood control facilities. Obviously, the governmental immunity laws do not apply to them.

### 2.2.1 Planning Drainage Improvements

As a general rule, municipalities are under no legal duty to construct drainage improvements unless public improvements necessitate drainage—as in those situations in which street grading and paving or construction of schools accelerates or alters storm runoff. Denver v. Mason, 88 Colo. 294, 295 P. 788 (1931); Denver v. Capelli, 4 Colo. 25, 34 Am. Rep. 62 (1877); Daniels v. City of Denver, 2 Colo. 669 (1875). This is because statutory provisions authorizing municipal drainage improvements and flood control are generally written in non-mandatory language. Thus, absent mandatory statutory language imposing a duty on municipalities or judicial imposition of an implied duty to avoid or abate injuries, municipalities are not liable for failing to provide drainage or flood control.

As noted earlier, public entities are immune from liability for the design, construction, and maintenance of drainage and flood control facilities unless a claim is based upon inverse condemnation. Therefore, those same public entities would also be immune from liability for the planning of drainage improvements.

In the case of Larry H. Miller Corporation-Denver v. Urban Drainage and Flood Control District, et.al. 64 P.3d 941 (Colo. App. 203), Urban Drainage and Flood Control District (UDFCD) was sued by a property owner (Miller) who was damaged by severe flooding on its property causing damages to motor vehicles exceeding \$525,000. One of the Miller's claims was that UDFCD had produced a master plan including Miller's property which was intended to analyze the hydraulic, hydrologic, and existing stormwater systems' capacity and to develop alternative plans to handle stormwater flows to minimize safety hazards and damage resulting from flooding of streets and private property and UDFCD did not follow through

and construct the recommended drainage and flood control improvements. The Colorado Court of Appeals held that there was no requirement that UDFCD own, operate, or maintain any drainage facilities or to acquire property to protect it from flooding. Therefore, in most cases, unless there is a specific statutory requirement to act, public entities (even when aware of a potential problem) are not required to expend funds to remedy that problem. The Court's reasoning being that, in this case, UDFCD was in the best position to allocate its resources.

### 2.2.2 Construction, Maintenance, and Repair of Drainage Improvements

Although municipalities or other public entities can no longer be held legally responsible for damage caused to the public by their negligence, other legal theories have been used to impose liability on municipalities for faulty construction and maintenance of drainage improvements. Thus, a municipality may incur liability for trespass, Barberton v. Miksch, 128 Ohio St. 169, 190 N.E. 387 (1934) (casting water upon the land of another by seepage or percolation resulting from construction and maintenance of a reservoir was a trespass by the municipality); an unconstitutional taking, Mosley v. City of Lorain, 43 Ohio St. 2d 334, 358 N.E. 2d 596 (1976) (the city had effectively appropriated the plaintiff's property by constructing a storm sewer system which channeled a greater volume of water into the creek than the creek could reasonably be expected to handle without flooding); taking, Lucas v. Carney, 167 Ohio St. 416, 149 N.E. 2d (1958) (construction of a public improvement on county property, which greatly increased the amount and force of surface water that flowed onto the plaintiff's property, overflowing and inundating it, raised a claim of pro tanto appropriation); or nuisance, Mansfield v. Bolleet, 65 Ohio St. 451, 63 N.E. 8.6 (1902) (a municipality is liable if it causes drainage to be emptied into a natural watercourse and substantially damages a downstream landowner). Even in the absence of negligence, nuisance, trespass, or taking, the evolving doctrine of inverse condemnation is being used to permit landowners to obtain compensation from a municipality where storm runoff from municipal projects is diverted across another's land on the theory that the city has taken a drainage easement. Thus, like an easement for noise emanating from the municipal airport, physical entry by the public entity or statutory allowance of compensatory damages is not required in order for landowners to recover damages.

In several Colorado cases, however, municipalities have not incurred liability for faulty construction where they are found to be upstream proprietors with a natural easement for drainage—even when water is sent down in a manner or quantity to do more harm than formerly. City of Englewood v. Linkenheil, 362 P.2d 186 (1961) (the city's action in channeling water by a system of drains, catch basins, intakes, and pipes, from a higher place to a place contiguous to the land of the plaintiff, which was a natural drainage area, so as to overflow onto the land of plaintiff did not constitute a taking of property without just compensation); City and County of Denver v. Stanley Aviation Corporation, 143 Colo. 182, 352 P.2d 291 (1960) (plaintiff could not recover from the city for damage caused by flood waters which backed onto lower land on its theory that the city had been negligent or failed to use due care in installing a pipe adequate to carry the waters); Aicher v. Denver, 10 Colo. App. 413, 52 P. 86 (1897) (the city was not found liable for damage where street grade was changed, trolley tracks were permitted in a street, and a culvert was built too small, but the landowner was declared to be in the unfortunate position of having built below the grade of the street).

The CGIA provides in 24-10-103 (1) C.R.S. that maintenance does not include any duty to upgrade, modernize, modify, or improve the design or construction of a facility. Therefore, a public entity, under this statute, would not be found to have failed to maintain a facility if it failed to perform one or more of these enumerated actions. However, if a public entity fails to maintain a facility other than the excluded enumerated actions above, such failure could subject that entity to a claim that such failure was negligent, and such entity would not be protected by the CGIA.

### 2.2.3 Summary

In general, in the absence of negligence, a municipality will not be held liable for increased runoff occasioned by the necessary and desirable construction of drains and sewers. Denver v. Rhodes, 9 Colo. 554, 13 P. 729 (1887). Nor will a municipality be held liable for damages caused by overflow of its sewers or drains occasioned by extraordinary, unforeseeable rains or floods. 18 McQuillan, *Municipal Corporations*, §53.124 (3rd ed. 1971).

Municipal liability may attach when a claim is made alleging inverse condemnation or the taking of property rights without compensation and where a municipality:

1. Collects surface water and casts it in a body onto private property where it did not formerly flow.
2. Diverts, by means of artificial drains, surface water from the course it would otherwise have taken and casts it in a body large enough to do substantial injury on private land, where, but for the artificial drain, it would not go.
3. Fills up, dams back, or otherwise diverts a stream of running water so that it overflows its banks and flows on the land of another. A municipality is also liable if it fails to provide a proper outlet for drainage improvements constructed to divert surface waters or if it fails to exercise ordinary care in the maintenance and repair of drainage improvements.

This latter liability attaches when it is determined that a municipality has not exercised a reasonable degree of watchfulness in ascertaining the condition of a drainage system to prevent deterioration or obstruction. 13 McQuillan, *Municipal Corporations*, §37.254 (3rd ed. 1971). See, also, Malvern v. City of Trinidad, 123 Colo. 394, 229 P.2d 945 (1951).

Thus, the best rule to follow in planning for the construction of drainage improvements, whether following the natural watercourse or artificially draining surface water, is that a municipality is liable if it actively injures private property as a result of improvements made to handle surface water. A municipality in Colorado appears to be in a much stronger position if it can establish that the improvement followed natural drainage patterns. Drainage District v. Auckland, 83 Colo. 510, 267 P. 605 (1928); City of Englewood v. Linkenheil, 362 P.2d 186 4961); City of Boulder v. Boulder and White Rock Ditch and Reservoir Company, 73 Colo. 426, 216 P. 553 (1923). See Kenworthy, "Urban Drainage: Aspects of Public and Private Liability," July-August 1962, *DICTA*, p. 197; Shoemaker, "An Engineering-Legal Solution to Urban Drainage Problems," 45 *Denver Law Journal* 381 (1968).

## 2.3 Municipal Liability for Acts of Others

### 2.3.1 Acts or Omissions of Municipal Officers, Agents, or Employees

The general rule is that a municipality is not liable under the doctrine of respondent superior for the acts of officers, agents, or employees that are governmental in nature but is liable for negligent acts of its agents in the performance of duties relating to proprietary or private corporate purposes of the city. Denver v. Madison, 142 Colo. 1, 351 P.2d 826 (1960). The construction, maintenance, and repair of drainage improvements have been regarded as proprietary or corporate functions. Denver v. Maurer, 47 Colo. 209, 106 P. 875 (1910). Although the governmental-proprietary distinction has been abolished by statute in Colorado, the distinction apparently still applies whenever the injury arises from the act, or failure to act, of a public employee who would be, “or heretofore has been personally immune from liability.” 24-10-106 C.R.S. Thus, a municipality may be held liable for the acts of its officers, agents, or employees for injuries resulting from the design, construction or maintenance of drainage and flood control facilities when the claim is based on inverse condemnation for the taking of property rights without compensation.

Before an individual can recover damages from a public entity for injuries caused by the public entity or one of its employees, the CGIA requires written notice to the public entity involved within 180 days after the date of discovery of the injury. Otherwise, failure to notify is a complete defense to a personal injury action against a municipality. 24-10-109 C.R.S. Kristensen v. Jones, 575 F.2d 854 (1978).

### 2.3.2 Municipal Liability for Acts of Developers

Unless an ordinance or statute imposes a duty on a municipality to prevent or protect land from surface water drainage, a municipality will not incur liability for wrongfully issuing building permits, failing to enforce an ordinance, or approving defective subdivision plans. Breiner v. C & P Homebuilder’s Inc., 536 F.2d 27 (3rd Cir. 1976), reversing the District Court. (In a suit by landowners in an adjacent township against a borough, its engineers, and subdivision developer for damages caused by increased flow of surface water from development where the borough approved a subdivision plan which did not provide drainage facilities and issued building permits, the borough was not liable because it owed no duty to landowners outside its boundaries. However, the developer was held liable.)

One state court, however, has held that a municipality is liable for damages where the municipality has furnished building permits to a contractor for development of an industrial complex which benefited the village financially but also diminished surface area available for drainage of water, causing flooding of neighboring servient estates. Myotte v. Village of Mayfield, 375 N.E.2d 816 (1977). In Myotte, the village’s liability was based on the following reasoning:

To require the developer to pick up the cost of flood prevention by requiring him to acquire land along stream margins for widening or deepening to accommodate accelerated flow, would subject him to possible overreaching by riparian owners. The developer has no power of eminent domain. Municipalities do have powers of condemnation. Accordingly, as an advantaged party with the power to protect itself from crisis pricing, it seems reasonable and just that the municipality should either enlarge the stream to accommodate water accelerated from permitted improvements that enrich it or pay the consequences. Myotte, supra at 820. (Day, J. concurring.). See also, Armstrong v. Francis Corporation, 20 N.J. 320, 120 A.2d 4 (1956); Sheffet v. County of Los Angeles, 3 Cal. App. 3d 720 (1970); Powers, et al., County of Clark and Clark County Flood Control District, District Court, State of Nevada (No. A 125197) (1978).



There is a trend toward imposing a greater burden or responsibility on municipalities for the drainage consequences of urban development. See Wood Brothers Homes, Inc. v. City of Colorado Springs, 568 P.2d 487 (1977) (where the city abused its discretion by not granting variance and by assessing the entire cost of a major drainage channel on the developer, where the area to be served by the major drainage channel already suffered from occasional flooding and needed an expanded drainage facility whether the property was developed or not).

## **2.4 Personal Liability of Municipal Officers, Agents, and Employees**

An injured person always has a remedy against the original tortfeasor even if no recovery may be had from the municipality for acts of its officers, agents, or employees in discharge of governmental functions. Denver v. Madison, 142 Colo. 1, 351 P.2d 826 (1960). Thus, public employees generally have been personally liable for injuries caused by their negligent actions within the scope of employment, even when the defense of sovereign immunity was available to their employers. Antonopoulos v. Town of Telluride, 187 Colo. 392, 532 P.2d 346 (1975); Liber v. Flor, 143 Colo. 205, 353 P.2d 590 (1960). Since an injured person's right to sue the negligent employee of an immune entity derives from the common law, the Colorado Supreme Court will not infer legislative abrogation of that right absent clear legislative intent. Thus, the CGIA is only directed toward liability of public entities. Kristensen v. Jones, 574 P.2d 854 (1978) (a bus driver for the regional transportation district was found personally liable for injuries sustained in a collision with the district's bus, and written notice was not a condition precedent to a suit against a public employee in his or her individual capacity).

The CGIA provides both for the defense of any governmental employee who is sued individually as a result of the employee's acts during the performance of his or her duties as well as the payment of any judgment or settlement. The act provides in part that a public entity shall be liable for the payment of all judgments and settlements of claims against any of its public employees where the claim against the public employee arises out of injuries sustained from an act or omission of such employee occurring during the performance of his or her duties and within the scope of employment, except where such act or omission is willful and wanton or where sovereign immunity bars the action against the public entity (24-10-110 (b)(1) C.R.S.).

Therefore, it is possible for an employee to be personally liable for a negligent act and the public entity to escape liability. Such a situation would arise when the claimant or employee fails to give proper notice to the public entity, thus providing that entity with the defense of lack of jurisdiction against it. However, the public employee would have no such defense.

## 3.0 Drainage Improvements by a Local Government

In an era of increasing urbanization and suburbanization, drainage of surface water most often becomes a subordinate feature of the more general problem of proper land use—a problem acutely sensitive to social change. Pendergast v. Arkin, 236 S.E. 2d 787, 796 N. Carolina.

### 3.1 Constitutional Power

A municipality's inherent police powers enable it to enact ordinances that serve the public's health, safety, morals, or general welfare. Ordinances addressing drainage problems are clearly a proper exercise of a municipality's police powers. Wood Brother's Homes, Inc. v. City of Colorado Springs, 568 P.2d 487, 490 (1977). Hutchinson v. Valdosta, 227 U.S. 303, 308 (1913).

### 3.2 Statutory Power

#### 3.2.1 Municipal Statutes

##### **Municipal Powers—Public Property and Improvements**

31-15-701, 31-15-714 C.R.S. The statute grants municipalities the power to establish, improve, and regulate such improvements as streets and sidewalks, water and water works, sewers and sewer systems, and water pollution controls. In addition, a municipality may, among other powers, “deepen, widen, cover, wall, alter or change the channel of watercourses.” 31-15-711 (1) (a) C.R.S.

##### **Public Improvements—Special Improvement Districts in Municipalities**

31-25-501, 31-25-540 C.R.S. The statute authorizes municipalities to construct local improvements and assess the cost of the improvements wholly or in part upon property specially benefited by such improvements. By ordinance, a municipality may order construction of district sewers for storm drainage in districts called storm sewer districts.

##### **Public Improvements—Improvement Districts in Municipalities**

31-25-601, 31-25-630 C.R.S. The statute authorizes municipalities to establish improvement districts as taxing units for the purpose of constructing or installing public improvements. The organization of districts is initiated by a petition filed by a majority of registered electors of the municipality who own real or personal property in the district.

##### **Sewer and Water Systems—Municipalities**

31-35-401, 31-35-417 C.R.S. The statute authorizes municipalities to operate, maintain, and finance water and sewage facilities for the benefit of users within and without their territorial boundaries. Sewerage facilities are defined as “any one or more of the various devices used in the collection, treatment, or disposition of sewage or industrial wastes of a liquid nature or storm, flood, or surface drainage waters....” 31-35-491(6) C.R.S.

#### 3.2.2 County Statutes

##### **Public Improvements—Sewer and Water Systems**

30-20-401, 30-20-422 C.R.S. The statute authorizes county construction, maintenance, improvement and financing of water and sewerage facilities for the county's own use and for the use of the public and private consumers and users within and without the county's territorial limits.

**County Public Improvement Districts**

30-20-501, 30-20-531 C.R.S. The statute authorizes creation of public improvement districts within any county as taxing units for purposes of constructing, installing, or acquiring any public improvement. 30-20-513 C.R.S. lists special benefits for purposes of assessing improvements within a public improvement district, particularly with respect to storm sewer drainage and drainage improvements to carry off surface waters.

**Public Improvements—Local Improvement Districts—Counties**

30-20-601, 30-20-626 C.R.S. The statute authorizes a county by resolution to construct local improvements and assess costs thereof wholly or in part upon property specially benefited by such improvements.

**Flood Control—Control of Stream Flow**

30-30-101, 30-28-105 C.R.S. The statute authorizes the board of county commissioners of each county for flood control purposes only:

...to remove or cause to be removed any obstruction to the channel of any natural stream which causes a flood hazard, and for such purpose only the board of county commissioners shall have a right of access to any such natural stream, which access shall be accomplished through existing gates and lanes, if possible. Such authority includes the right to modify existing diversion or storage facilities at no expense to the diverter of a water right, but it shall in no way alter or diminish the quality or quantity of water entitled to be received under any vested water right. 30-30-102 (1) C.R.S.

**Conservancy Law—Flood Control**

37-1-101, 37-8-101 C.R.S. The statute authorizes the district court for any county to establish conservancy districts for any of the following purposes:

Preventing floods; regulating stream channels by changing, widening, and deepening the same; regulating the flow of streams; diverting, controlling, or in whole or in part eliminating watercourses; protecting public and private property from inundation...

**Drainage Districts**

37-20-101, 37-33-109 C.R.S. The statute authorizes owners of agricultural lands susceptible to drainage by the same general system of works to petition the board of county commissioners for the organization of a drainage district.

**3.2.3 State Statutes****Colorado Land Use Act**

24-65-101, 24-65-105 C.R.S. The statute establishes a nine-member Colorado land use commission. Among other powers, the commission has authority to assist counties and municipalities in developing guidelines for developing land uses and construction controls within designated floodways.

**Drainage of State Lands**

37-30-101, 37-30-105 C.R.S. The statute authorizes the state board of land commissioners to make contracts with any person, corporation, association, or drainage district to provide drainage of state lands.

**Water Conservation Board of Colorado**

37-61-101, 37-60-123 C.R.S. The statute creates a 13-member state water conservation board for purposes of water conservation and flood prevention. An important duty of this board is to “designate and approve storm or floodwater runoff channels or basins, and to make such designations available to

legislative bodies of cities and incorporated towns, and counties of this state.” 30-60-123 C.R.S.

### **State Canals and Reservoirs**

37-88-101, 37-88-109 C.R.S. The statute authorizes the Department of Corrections to locate, acquire, and construct ditches, canals, reservoirs, and feeders for irrigating and domestic purposes for the use of the State of Colorado. The Board of County Commissioners have charge and control of any state reservoir in their county including the obligation to maintain and keep said reservoir in good condition at the county’s expense. In addition, the county in which the state reservoir is located is liable for any damages resulting from breakage of the dams or water discharges there from.

### **Regulatory Impairment of Property Rights**

29-20-201 C.R.S. This law became effective July 1, 1999. One of the legislative declarations of the act is that “The general assembly further finds and declares that an individual private property owner should not be required, under the guise of police power regulation of the use and development of property, to bear burdens for the public good that should more properly be borne by the public at large.” The main thrust of the act is contained in 29-20-203 (1) C.R.S., which reads as follows:

In imposing conditions upon the granting of land-use approvals, no local government shall require an owner of private property to dedicate real property to the public, or pay money to a public entity in an amount that is determined on an individual and discretionary basis, unless there is an essential nexus between the dedication or payment and a legitimate local government interest, and the dedication or payment is roughly proportional both in nature and extent to the impact of the proposed use or development of such property. This section shall not apply to any legislatively formulated assessment, fee, or charge that is imposed on a broad class of property owners by local government.

The act goes on to prescribe the remedies available to a private property owner who believes his or her rights have been violated under the act. However, unlike most litigation, it is the burden of the local government and not the plaintiff “to establish, based upon substantial evidence appearing in the record” that the dedication or payment required by the local government is roughly proportional to the impact of the proposed use of the subject property.

Therefore, the Colorado legislature has now established a standard that is consistent with the leading case law in this area to assist local governments with reaching a safe harbor when imposing conditions on development. The concepts are fairly simple. First, the conditions imposed have to have some causal relationship with the impact of the development and, second, those conditions must be “roughly proportional” to the impact of the development. However, it should be noted that these restrictions relate only to those instances where the local government is negotiating individually with a developer as to what conditions will be imposed by the local government. The act does provide that, if the local government is legislatively imposing conditions for development on a broad class of property owners, the “essential nexus” and “roughly proportional” requirements of the act do not apply to those legislatively imposed conditions.

**Intergovernmental Relationships**

29-1-201 C.R.S. In 1974, Section 2 of Article XI of the state constitution was amended to permit and encourage governments to make the most efficient and effective use of their powers and responsibilities by cooperating and contracting with other governments. 29-1-203 C.R.S. provides more detail in regard to how that cooperation is to be carried out. It reads in part as follows:

Governments may cooperate or contract with one another to provide any function, service, or facility lawfully authorized to each of the cooperating or contracting units, including the sharing of costs, the imposition of taxes, or the incurring of debt, only if such cooperation or contracts are authorized by each party thereto with the approval of its legislative body or other authority having the power to so approve.

**3.2.4 Urban Drainage and Flood Control Act**

32-11-101 C.R.S., et. seq., established the Urban Drainage and Flood Control District (UDFCD), including all of the City and County of Denver and the urbanized and urbanizing portions of Adams, Arapahoe, Boulder, Broomfield, Douglas, and Jefferson Counties. A twenty-three member board of directors, comprised of twenty-one elected officials and two professional engineers, is given the power to (1) plan solutions to drainage and flood control problems (with an authorized mill levy of 0.1 mill); (2) construct drainage and flood control improvements (with an authorized mill levy of 0.4 mill); (3) maintain such improvements and other natural drainageways in UDFCD (with an authorized mill levy of 0.4 mill); and (4) construct drainage and flood control improvements in and adjacent to the South Platte River (with an authorized mill levy of 0.1 mill). The board also has the power to adopt and enforce a floodplain regulation.

**3.2.5 Drainage Authority**

29-1-204.2 C.R.S. et. seq. permits any combination of municipalities, special districts, or other political subdivisions of the State of Colorado to own and operate drainage facilities and, by contract with each other, to establish a drainage authority to be used by such contracting parties to effect development of drainage facilities in whole or in part for the benefit of the inhabitants of such contracting parties or others.

## 4.0 Financing Drainage Improvements

The ability of one owner to develop land, install impervious surfaces, alter drainage paths, and accelerate runoff onto other properties involves more than issues of what rights and relief should be accorded neighboring property owners. Urbanization may double or triple the peak flows of 5- and 10-year floods. Lands far downstream may be severely affected by the cumulative impact of unplanned and unregulated changes in drainage patterns due to urban clearance, grading, and development. Increasingly, the costs of uncontrolled drainage modifications and stormwater management have fallen on the state and federal budgets. Westen, *Gone With the Water—Drainage Rights and Storm Water Management in Pennsylvania*, 22 Vill. L. Rev. 901, 902 (1976-77).

### 4.1 Capital Improvement

Resources from the current budget, usually derived from sales, property, and income taxes, can be used to finance drainage improvements. Since the cost is paid from the “general fund” or “capital improvement fund” and no specific property tax is levied, the financing is relatively simple.

### 4.2 Local Improvement

Financing for drainage improvements through local improvements or as part of a general bond issue requires that all property be assessed on a valuation basis. Since a majority of all taxpaying electors must approve the decision, the success of this method usually turns on how well the facts (needs) have been prepared and how well a plan has been developed.

### 4.3 Drainage / Stormwater Authority

Drainage authorities also known as stormwater authorities have been created by either single governmental entities or combinations thereof in order to raise funds and use those funds for the design, construction and maintenance of drainage and flood control facilities. Often these authorities fund these improvements by assessing a fee on real property based in part upon the impervious area of each property and whether it is a residence or a commercial property. For example, a significant number of utilities base fees on both total site area and total impervious area. Others utilize “intensity of development” factors. Finally, many others include sophisticated programs of credits and adjustments, depending on site-specific factors. The majority of these authorities have become highly successful since they do not rely on general funds from the forming governments but, instead generate their own source of revenue that does not impact the governmental entities taxing authority. In Colorado, as a result of Colorado statutory law, these drainage and stormwater authorities can be created and funded by the assessment of fees without a vote of the citizens within the boundaries of the authority.

### 4.3 Special Improvement

When drainage improvements are financed as special improvements, the property assessed must be specially benefited. In Colorado, benefits, for purposes of special assessments, are defined in several statutory sections. (See 30-20-513, 30-20-606, 31-25-507, and 37-23-101.5 C.R.S.). For example, 37-23-101.5 C.R.S. provides:

Determination of special benefits—factors considered. (1) The term ‘benefit,’ for the purposes of assessing a particular property within a drainage system improvement district, includes, but is not limited to, the following: (a) any increase in the market value of the property; (b) the provision for accepting the burden from specific dominant

property for discharging surface water onto servient property in a manner or quantity greater than would naturally flow because the dominant owner made some of his property impermeable; (c) any adaptability of property to a superior or more profitable use; (d) any alleviation of health and sanitation hazards accruing to particular property or accruing to public property in the improvement district, if the provision of health and sanitation is paid for wholly or partially out of funds derived from taxation of property owners of the improvement district; (e) any reduction in the maintenance costs of particular property or of public property in the improvement district, if the maintenance of the public property is paid for wholly or partially out of funds derived from taxation of property owners of the improvement district; (f) any increase in convenience or reduction in inconvenience accruing to particular property owners, including the facilitation of access to and travel over streets, roads, and highways; (g) recreational improvements accruing to particular property owners as a direct result of drainage improvement.

This statute was adopted by the Colorado legislature to define “benefits,” a term previously defined only by courts. See Shoemaker, “What Constitutes ‘Benefits’ for Urban Drainage Projects,” 51 *Denver L. Journal* 551 (1974).

A special assessment for a local improvement must specifically benefit or enhance the value of the premises assessed in an amount at least equal to the burden imposed. Bloom v. City of Fort Collins, 784 P.2d 304 (Colo. 1989). Although a benefit to the premises assessed must at least be equal to the burden imposed, the standard of apportionment of local improvement costs to benefits is not one of absolute equality, but one of reasonable approximation. Satter v. City of Littleton, 185 Colo. 90, 522 P.2d 95 (1974). A presumption of validity inheres in a city council’s determination that benefits specifically accruing to properties equal or exceed assessments thereon. Satter, *supra*. Further, a determination of special benefits and assessments is left to the discretion of municipal authorities, and their determination is conclusive in the courts unless it is fraudulent or unreasonable. Orchard Court Development Co. v. City of Boulder, 182 Colo. 361, 513 P.2d 199 (1973). A determination of no benefit in an eminent domain proceeding does not preclude a subsequent special assessment providing a landowner’s property benefited from construction of the improvement. City of Englewood v. Weist, 184 Colo. 325, 520 P.2d 120 (1974). See, also, Denver v. Greenspoon, 140 Colo. 402, 344 P.2d 679 (1959); Town of Fort Lupton v. Union Pacific R.R. Co., 156 Colo. 352, 399 P.2d 248 (1965); Houch v. Little River District, 239 U.S. 254 (1915); and Miller and Lux v. Sacramento Drainage District, 256 U.S. 129 (1921).

#### 4.4 Service Charge

UDFCD can charge service fees for the use of its facilities or services and thereby finance its improvements. 32-11-217 (1)(e), 32-11-306 C.R.S. provides:

Such service charges may be charged to and collected in advance or otherwise by UDFCD at any time or from time to time from any person owning real property within UDFCD or from any occupant of such property which directly or indirectly is, has been, or will be connected with the drainage and flood control system of UDFCD or from which or on which originates or has originated rainfall, other surface and subsurface drainage, and storm and flood waters (or any combination thereof) which have entered or may enter such system, and such owner or occupant of any such real property shall be liable for and shall pay such service charges to UDFCD at the time when and place where such service charges are due and payable.

Storm and flood control facilities fall within the definition of “sewerage facilities” defined in 31-35-401 (6) C.R.S.; 31-35-402 (1) C.R.S. states:

In addition to the powers which it may now have, any municipality, without any election of the taxpaying or qualified electors thereof, has power under this part for:

(f) to prescribe, revise and collect in advance or otherwise, from any consumer or any owner or occupant of any real property connected therewith or receiving service therefrom rates, fees, tolls, and charges or any combination thereof for the services furnished by, or the direct or indirect connection with, or the use of, or any commodity from such water facilities or sewerage facilities or both...

A service charge is neither a tax nor a special assessment but is a fee for the sole purpose of defraying the cost of establishing and maintaining a storm drainage and flood control utility. Western Heights Land Corp. v. City of Fort Collins, 146 Colo. 464, 362 P.2d 155 (1961). See, also, City of Aurora v. Bogue, 176 Colo. 198, 4-9 P.2d 1295 (1971); Brownbriar Enterprises v. City and County of Denver, 177 Colo. 198, 493 P.2d 352 (1972); and City of Boulder v. Arnold, 978 P.2d 149 (Colo. App. 1976) which upheld the City of Boulder's flood control fee. Counties in Colorado have similar powers pursuant to 30-20-402 (1) C.R.S.

#### 4.5 Developer's Cost

A county planning commission or the board of adjustment of any county may condition any portion of a zoning resolution, or any amendments or exceptions thereto, upon "the preservation, improvement, or construction of any storm or floodwater runoff channel designated and approved by the Colorado Water Conservation Board." 30-28-111 (2) C.R.S.

Every Colorado County is required to have a planning commission to develop, adopt and enforce subdivision regulations. Among the provisions that the board of county commissioners must include in the county's regulations are those requiring developers to submit:

1. A plat and other documentation showing the layout or plan of development, including, where applicable, the following information:
  - i. Estimated construction cost and proposed method of financing of the streets and related facilities, water distribution system, sewage collection system, storm drainage facilities, and such other utilities as may be required of the developer by the county.
  - ii. Maps and plans for facilities to prevent stormwater in excess of historic runoff caused by the proposed subdivision from entering, damaging, or being carried by conduits, water supply ditches and appurtenant structures, and other storm drainage facilities. 30-28-133 (3)(c) C.R.S. Although Colorado law does not require it, in certain instances the maps and plans for facilities are required to include storage, treatment, and conveyance facilities for the total runoff from the proposed subdivision.

In addition, subdivision regulations must include provisions governing standards and technical procedures applicable to storm drainage plans and related designs, in order to ensure proper drainage ways, which may require, in the opinion of the board of county commissioners, detention facilities which may be dedicated to the county or the public, as are deemed necessary to control, as nearly as possible, stormwaters generated exclusively within a subdivision from a one-hundred year storm which are in excess of the historic runoff volume of stormwater from the same land area in its undeveloped and unimproved condition. 30-28-133 (4)(b) C.R.S.

The United States Supreme Court in 1987 issued its opinion in the case of Nollan v. California Coastal Comm. 107 S.Ct. 3141 (1987). This was the first United States Supreme Court case to discuss exactions



imposed upon developers by local governments. The Court in Nollan held that the Coastal Commission's requirement that conditioning the granting of a rebuilding permit upon the landowner dedicating an easement that would allow the public to pass across the landowner's beach was an unconstitutional taking under the just compensation clause of the Fifth Amendment. The reasoning of the Court was that the requirement of the grant of the easement had no relationship to the request of the landowner for a rebuilding permit nor was it related to the impact of the issuance of that permit. The Court thus introduced the essential nexus test in regard to governmental exactions in exchange for building permits. In other words, the exaction by the government must have a relationship to the impact of the requested development. Although initially the Nollan case was thought to apply to both exactions of interest in land by government as well as the assessment of fees, subsequent cases have held that Nollan is only applicable to exactions and not fees.

In 1994, the United States Supreme Court in the case of Dolan v. City of Tigard 114 S.Ct. 2309 (1994) considered a case which involved drainage and exactions by the city in the form of dedication of property lying within the 100 year floodplain as well as an additional 15 feet as a pedestrian/bicycle pathway in order to obtain a permit to develop a site within the city. The U.S. Supreme Court added a second consideration to the one already contained in the Nollan case. The Court held that "we must first determine whether the 'essential nexus' exists between the legitimate state interests and the permit condition exacted by the city. If we find that a nexus exists, we must then decide the required degree of connection between the exactions and the projected impact of the proposed development." The Court went on to hold:

We think a term such as "rough proportionality" best encapsulates what we hold to be the requirement of the Fifth Amendment. No precise mathematical calculation is required, but the city must make some sort of individualized determination that the required dedication is related both in nature and extent to the impact of the proposed development.

This case too was thought initially to apply to both exactions in land by government as well as the assessment of fees. Again, subsequent cases limited the application of the Dolan case to exactions and not fees.

Subsequent to these cases, the Colorado Legislature enacted a statute codifying the requirements of Nollan and Dolan. See Section 3.2.3 *Regulatory Impairment of Property Rights*.

The "Local Government Land Use Control Enabling Act" C.R.S. § 29-20-104.5 C.R.S. became law in 2001 and its focus was on impact fees charged by local governments. The most important portion of the statute is set forth below.

(1) Pursuant to the authority granted in section 29-20-104 (1) (g) and as a condition of issuance of a development permit, a local government may impose an impact fee or other similar development charge to fund expenditures by such local government on capital facilities needed to serve new development. No impact fee or other similar development charge shall be imposed except pursuant to a schedule that is:

- (a) Legislatively adopted;
- (b) Generally applicable to a broad class of property; and
- (c) Intended to defray the projected impacts on capital facilities caused by proposed development.

(2) A local government shall quantify the reasonable impacts of proposed development on existing capital facilities and establish the impact fee or development charge at a level no greater than necessary to defray such impacts directly related to proposed development. No impact fee or other similar development charge shall be imposed to remedy any deficiency in capital facilities that exists without regard to the proposed development.

(3) Any schedule of impact fees or other similar development charges adopted by a local government pursuant to this section shall include provisions to ensure that no individual landowner is required to provide any site specific dedication or improvement to meet the same need for capital facilities for which the impact fee or other similar development charge is imposed.

(4) As used in this section, the term "capital facility" means any improvement or facility that:

(a) Is directly related to any service that a local government is authorized to provide;

(b) Has an estimated useful life of five years or longer; and

(c) Is required by the charter or general policy of a local government pursuant to a resolution or ordinance.

The "Local Government Land Use Control Enabling Act" restates many of the criteria for the imposition of fees by local governments, in regard to obtaining land-use approvals, which are discussed above. However, it also adds a number of other criteria that need to be met in order to not violate the statute, including the following:

1. The impact fee must be limited to impacts on capital facilities by the proposed development.
2. The local government must quantify the reasonable impacts that are directly related to the proposed development and charge a fee no greater than necessary to defray those impacts.
3. No impact fee shall be imposed to remedy any deficiency in capital facilities that exists without regard to the proposed development.
4. Both an impact fee and a site specific dedication may not be required to meet the same need for capital facilities.
5. A capital facility is defined as having a useful life of five years or longer.

The above is the general framework and legal authority that should be considered when attempting to comply with applicable statutory law and case law addressing the constitutional questions surrounding the imposition of a drainage basin fee.

Developers may be charged for general costs of drainage infrastructure required due to new development within and outside of the basin in which they are developing. However, in order to do so, it must be established that the impact fee is no greater than necessary to defray the cost of the impacts of that specific development. As long as an impact can be established outside of a drainage basin then an impact fee may include those impacts as well as those inside the drainage basin in which the development is located.

Developers may be charged the costs of drainage infrastructure associated with the runoff created by development if, again, those impact fees have been quantified by the local government and those fees directly relate to the impact of a specific development. The method of calculation of those fees only has to have a rational foundation and does not have to be the best, if there is a rational reason for the selection of the method of calculation.

Developers can also be charged for impact fees that contain a calculation for use of existing local government's stormwater systems to accommodate water originating from specific developments. Again, such impact fees must be no greater than necessary to defray the costs of the impacts of that specific development. In addition, the impact fee shall not be imposed to remedy any deficiency in capital facilities that exists without regard to the proposed development. The rationale for permitting an impact fee for use of existing facilities is that the increased runoff diminishes the capacity of the existing facilities which eventually will require additional improvements to address that diminished capacity.

The selection of whether the drainage fee will be uniform throughout the local government's boundary, by groups of basins with similar characteristics or by individual basins, is dictated by each of the requirements to meet the legal criteria set forth above as well as the ease in which the fee can be practically determined and implemented. The questions that need to be answered in the affirmative for one of these options to be selected are as follows:

1. Is there an essential nexus between the impact fee and the area grouping that the fee will apply to?
2. Is the impact fee roughly proportional to the needs of the grouping selected?
3. Does the fee defray impacts directly related to a proposed development?
4. Does the fee not remedy past deficiencies in capital facilities? and
5. Is there a rational foundation for the selection of the particular grouping?

In conclusion, based upon both case law from the U.S. Supreme Court and the Colorado courts as well as Colorado statutory law, there exists some protection for local governments in regard to drainage impact fees if such fees are legislatively enacted and there is no opportunity for local government to individually negotiate an extraction in exchange for a land-use approval.

In Wolf Ranch, LLC v. City of Colorado Springs, 220 P.3d 559 (Colo.2009) a drainage fee was imposed as a condition of land use approvals with a development. The fee was challenged and the Colorado Supreme Court held that because the Colorado General Assembly has authorized the fee, the fee was publicly promulgated on a per-acre basis and equally applied to all new development within the drainage basin; the fee was legally enforceable.

#### **4.6 The Taxpayers Bill of Rights, Article X, Section 20, Colorado Constitution**

On December 31, 1992 the Taxpayers Bill of Rights (TABOR) became effective. Its effect is to limit governmental spending generally so that "the maximum annual percentage change in each local district's fiscal year spending equals inflation in the prior calendar year plus annual local growth." In addition to a spending limitation, TABOR imposes a revenue limit that is similar to the spending limit. Finally, districts must have voter approval in advance for:

...any new tax, tax rate increase, mill levy above that for the prior year, valuation for assessment ratio increase for a property class, or extension of an expiring tax, or a tax policy change directly causing a net tax revenue gain to any district.

Prior to the passage of TABOR there were a number of cases that addressed whether a service charge was a tax. The first of note was Zelinger v. City and County of Denver, 724 P.2d 1356 (Colo. 1986) wherein a storm drainage service charge was attacked as an unconstitutional property tax and an unconstitutional denial of equal protection and due process guarantees to property owners. The storm drainage service charge applied to all owners of property in Denver and was used to pay for the operation, maintenance, improvement and replacement of the city's storm drainage facilities. The charge was based on the ratio of impervious to pervious land surface. The higher the ratio of impervious to pervious surface, the greater is the charge per square foot. The Colorado Supreme Court held that such a service charge was not a tax nor was it a violation of due process or equal protection. The court concluded with the following finding:

...although alternative cost allocation schemes may be equally well-suited or arguably better suited to serving the governmental interest in providing storm drainage facilities than the scheme actually adopted, the equal protection clauses do not authorize the invalidation of the scheme chosen unless it is without rational foundation.

The Zelinger case has continued as good law ever since 1986 and has been cited recently as the law of Colorado in regard to these matters. Thus, a storm drainage service charge similar to that adopted by Denver is not a tax and therefore is not subject to the limitations of TABOR.

In 1989 the Colorado Supreme Court revisited fees in the case of Bloom v. City of Fort Collins, 784 P.2d 304 (Colo. 1989). In that case the court considered a transportation utility fee and held that such a fee was not a property tax but rather a special fee imposed upon owners or occupants of developed lots fronting city streets and that such a fee is reasonably related to the expenses incurred by the city in carrying out its legitimate goal of maintaining an effective network of city streets. The court in reaching this conclusion considered any number of possibilities as to what this fee was and rejected the following as not applying: property tax, excise tax, and special assessment. It therefore found that the fee was a special fee that was a charge imposed on persons and property and reasonably designed to meet the overall cost of the service for which the fee is imposed.

Finally, in the case of City of Littleton v. State of Colorado, 855 P.2d 448 (Colo. 1993), the Colorado Supreme Court addressed another stormwater and flood management utility fee. The fee was enacted to prevent damage to property from accumulations and uncontrolled runoff of water. The ordinance declares that as the ultimate beneficiaries and users of the contemplated system, the owners of property within the city shall be required to pay a fee for the costs of constructing, operating, maintaining and replacing the system and its facilities. The state Community Colleges Board challenged the fee as a special assessment and thus something that could not be charged against the state. The court found that, despite the fact that the service fees did not specifically benefit the property owned by the state, it did create the capacity to remove excess water from property and prevent flooding, which benefited all property owners; thus, the fee is a permissible fee.

In conclusion, drainage fees, if properly structured, are not property taxes and can be implemented without TABOR implications. However, outside of Colorado, there have been five recent cases where each have held, for various reasons, that a "stormwater service charge," a "stormwater utility charge", and a "stormwater drainage service charge" are each a tax and not a fee. Those cases are Bolt v. City of Lansing, 561 N.W. 2d 423 (Mich. 1997); Fulton County Taxpayers Association v. City of Atlanta, Georgia, Superior Court of Fulton County, State of Georgia, Civil Action File Number: 1999 cv05897; City of Cincinnati v. United States, United States Court of Appeals for the Federal Circuit, 98-5039; Lewiston Independent School District et. al. v. City of Lewiston, Idaho Supreme Court, November 2011 (the stormwater fee is an unauthorized tax not reasonably related to a regulatory purpose) and Zweig v. Metropolitan St Louis Sewer District, Missouri Court of Appeals, March 2012 (stormwater charge is an unconstitutional tax).

#### **4.7 Water Activities—Enterprise Statute 37-45.1-101 C.R.S.**

This statute, which was adopted after the passage of TABOR, takes advantage of the exception in TABOR that the same does not apply to governmental enterprises by setting forth, in regard to water activities, what a governmental entity needs to do to become and remain an enterprise and thus not be subject to TABOR. Numerous Front Range cities have taken advantage of this statute to adopt enterprises without a vote of the people to address drainage and flooding issues in their municipalities.

The statute provides in regard to the establishment of a water activity enterprise that:

Any district which under applicable provisions of law has its own bonding authority may establish or may continue to maintain water activity enterprises for the purpose of pursuing or continuing water activities including...water project or facility activities, including the construction, operation, repair, and replacement of water or wastewater facilities. Any water activity enterprise established or maintained pursuant to this article is excluded from the provision of Section 20 of Article X of the state constitution.

The statute defines “water project or facility” as including a dam, storage reservoir, compensatory or replacement reservoir, canal, conduit, pipeline, tunnel, power plant, water or wastewater treatment plant, and any and all works, facilities, improvements, and property necessary or convenient for the purpose of conducting a water activity. The statute also defines water activity as including stormwater services.

Two restrictions in regard to water activity enterprises are that they cannot receive more than 10 percent of their annual revenues from grants from state and local governmental entities and that an enterprise may not tax.

### **5.0 Floodplain Management**

Floodplain management involves fuller use of non-structural techniques. See 24-65.1-202 (2)(a)(I) C.R.S. Such techniques include:

1. Floodplain zoning and building code ordinances to regulate flood area construction.
2. Flood insurance programs.
3. Flood warning systems, including notification to occupants of floodplains.

See Westen, *Gone With the Water—Drainage Rights and Storm Water Management in Pennsylvania*, 22 Vill. L. Rev., 901, 972 (1976-77).

## 5.1 Floodplain Regulations

### 5.1.1 Constitutional Considerations

The general principles of zoning were established in Village of Euclid v. Amber Realty Co., 272 U.S. 365 (1926), in which the U.S. Supreme Court stated:

While the meaning of constitutional guarantees never varies, the scope of their application must expand or contract to meet new and different conditions that are constantly coming within the field of their operation.

The court in Colorado has determined that zoning is justified as a valid exercise of police power, and that this legal basis for zoning legislation must be reconciled with the legitimate use of private property, in harmony with constitutional guarantees. Westwood Meat Market, Inc. v. McLucas, 146 Colo. 435, 361 P.2d 776 (1961); People ex rel. Grommon v. Hedgcock, 106 Colo. 300, 104 P.2d 607 (1940).

The adoption by a municipality of floodplain ordinances to regulate flood-prone areas is a valid exercise of police power and is not a taking. Morrison v. City of Aurora, 745 P.2d 1042 (Colo. App. 1987).

### 5.1.2 Statutory Grants of Power

Specific legislative action has given local governments authority to proceed in floodplain regulation. In Colorado, cities, counties, and UDFCD all have plenary grants of power.

The governing body of each municipality has the following authority:

To establish, regulate, restrict and limit such uses on or along any storm or floodwater runoff channel or basin, as such storm or floodwater runoff channel or basin has been designated and approved by the Colorado Water Conservation Board, in order to lessen or avoid the hazards to persons and damage to property resulting from the accumulation of storm or floodwaters. 31-23-301 (1) C.R.S.

Counties in Colorado are directly authorized by statute to adopt zoning plans concerned with regulating use in a floodplain area through the provisions of 30-28-111 (1) C.R.S.:

...the county planning commission may include in said zoning plan or plans provisions establishing, regulating, and limiting such uses upon or along any storm or water runoff channel or basin as such storm or runoff channel or basin has been designated *and* approved by the Colorado Water Conservation Board in order to lessen or avoid the hazards to persons and damage to property resulting from the accumulation of storm or flood waters.

Home rule counties and cities have the same powers as noted above. These powers may be expanded by charter as long as those powers do not violate the Colorado constitution dealing with home rule governmental entities.

UDFCD is authorized to:

...adopt, amend, repeal, enforce, and otherwise administer under the police power such reasonable floodplain zoning resolutions, rules, regulations, and orders pertaining to properties within the district of any public body or other person (other than the federal government) reasonably affecting the collection, channeling, impounding or disposition

of rainfall, other surface and subsurface drainage, and storm and flood waters (or any combination thereof), including without limitation variances in the event of any practical difficulties or unnecessary hardship and exceptions in the event of appropriate factors, as the board may from time to time deem necessary or convenient. In the event of any conflict between any floodplain zoning regulation adopted under this section and any floodplain zoning regulation adopted by any other public body, the more restrictive regulation shall control. (emphasis added) 32-11-218 (1) (f) (I) C.R.S.

Because of the underlined language above, UDFCD has proceeded on the basis that if local governments within UDFCD fail to adopt floodplain regulations, then UDFCD would administer its regulation within that local jurisdiction. Further, since UDFCD's regulation prohibits residential development within the floodway (the most hazardous portion of the floodplain), any local government failing to prohibit residential development within the floodway would be governed by UDFCD's regulation inasmuch as UDFCD's regulation would be "more restrictive" and, thus, controlling under the statute.

### 5.1.3 Court Review of Floodplain Regulations

The leading Colorado case is Famularo v. Adams County, 180 Colo. 333, 505 P.2d 958 (1973), in which the Colorado Supreme Court upheld the District Court's findings that (1) the Adams County Commissioners had authority to regulate, by resolution, the uses of land in unincorporated areas for "trade, industry, residence, recreation, or other purposes, and for flood control"; and (2) the regulation in question did not so limit the uses of plaintiff's land so as to violate the Colorado Constitution, Article II, §25 or the U.S. Constitution, Amendment XIV.

In the case of Kolwicz v. City of Boulder, 538 P.2d 482 (Colo. App. 1975) the court was asked to determine if a city resident had standing to sue the city to require the city council and its administrator to implement floodplain regulations by adopting a map that delineated the floodway and the flood storage areas within the floodplain, for which the city had adopted a map four years prior to the lawsuit. The court denied the city resident's request on the basis that nothing in the record showed that the resident herself had been aggrieved, wronged, or had any of her rights impaired or threatened as a result of the city council's failure to implement its regulations.

In the case of Hermanson v. Board of County Commissioners of Fremont, 595 P.2d 694 (Colo. App. 1979), the court addressed an assertion by the plaintiff that his property had been taken from him because of a series of regulatory obstructions to its development that had been imposed by the county. The plaintiff alleged that his property had been taken by inverse condemnation, and the court found that such an action is justified when there has been a taking of private property for public use without payment of just compensation by some public body that has the power of eminent domain. However, the court did acknowledge that it is true that the use of property may be regulated by valid exercise of the police power, if the regulation does not go beyond protection of the public health, safety, morals, and welfare. Therefore, it found that, when regulations are designed to depress value with a view to future acquisition, this may form the basis of a cause of action for compensation on the theory of inverse condemnation against the public entity initiating the regulation.

Finally, in the case of Morrison v. City of Aurora, 745 P.2d 1042 (Colo. App. 1987), a property owner alleged that the city's adoption of floodway restrictions was a taking of his property. The court found for the city, since an adoption by a municipality of floodplain ordinances to regulate flood-prone areas is a valid exercise of police power and is not a taking.

In Colorado, the legislature has taken the lead in granting local governments power to regulate flood hazard areas. Usually, courts interpret such regulation that follows on a case-by-case basis, depending on what is "reasonable" under the circumstances. Some guidelines that have emerged in anticipating

"reasonableness" follow.

### **Restriction of Uses**

The restriction of uses on property that would prevent a public harm, as opposed to the creation of a public *benefit*, removes the requirement of compensation to property owners who are restricted from the full use of their property. Dunham, *A Legal and Economic Basis for City Planning*, 58 Colum. L. Rev. 650 (1958).

The restrictions on the uses must not be so severe as to deny the owners a constitutional right to make "beneficial use" of their land because such restrictions would be confiscatory and void. Francis v. City and County of Denver, 160 Colo. 440, 418 P.2d 45 (1966). However, a zoning ordinance is not unconstitutional because it prohibits a landowner from using or developing his or her land in the most profitable manner. It is not required that a landowner be permitted to make the best, maximum or most profitable use of his or her property. Baum v. City & County of Denver, 363 P.2d 688 (Colo. 1961); and Sundheim v. Board of County Commissioners of Douglas County, 904 P.2d 1337 (Colo. App. 1995).

### **Health Regulations**

The relationship of the zoning restrictions to the public's health, safety, morals, and general welfare must be considered. Whether the zoning provisions are reasonable and for the promotion of the public's welfare must be determined by the court from the facts, circumstances, and locality in a particular case. DiSalle v. Giggall, 128 Colo. 208, 261 P.2d 499 (1953).

A similar matter in zoning restrictions was determined by the U.S. Supreme Court in upholding the validity of the police power in a zoning ordinance that prohibited excavation below a certain water table, which in effect deprived the property of its most beneficial use, stated:

The ordinance in question was passed as a safety measure, and the town is attempting to uphold it on that basis. To evaluate its reasonableness, we therefore need to know such things as to the nature of the menace against which it will protect the availability and effectiveness of other less drastic protective steps, and the loss which the appellants will suffer from the imposition of the ordinance. Goldblatt v. Town of Hempstead, (N.Y.) 369 U.S. 590 (1962).

This holding appears to coincide with the Colorado cases on the requirements for the determination by the court from facts, circumstances, and locality in a particular case, as to the reasonableness of the zoning ordinances in their promotion of the general welfare, and to prove that the restrictive use would bear a substantial relation to the public's health, safety, morals, or general welfare. DiSalle v. Giggall, supra; Westwood Meat Market, Inc. v. McLucas, supra.

### **Determination of Boundaries**

The boundaries of the floodplain should be accurately determined and based on a reasonable standard. Mallett v. Mamaroneck, 1313 N.Y. 821, 125 N.E. 2d 875 (1955).

The setting of the boundaries of the floodplain zone to determine the hydraulic reach of a potential flood should be determined accurately. The accuracy of which will be affected by terrain, river course, and other factors that will necessarily cause some variation from the initially adopted boundary.

The Federal Emergency Management Agency (FEMA), U.S. Army Corps of Engineers, Colorado Water Conservation Board (CWCB), UDFCD, and local governments have conducted extensive stream surveys throughout Colorado. There is extensive written guidance about the methodology to be used in conducting these surveys that are required to be completed using reasonable engineering / scientific standards and have often become an integral part of the floodplain zoning ordinances and resolutions



adopted by Colorado's cities and counties.

The CWCB has actively cooperated in the past to designate and approve such areas as delineated as a storm or "floodwater runoff channel or basin." Such approval or designation of a runoff channel or basin by the CWCB is required by statute prior to any action by a local government, including UDFCD, to set the boundaries on proposed floodplain zoning resolutions.

## 5.2 Flood Insurance

The National Flood Insurance Act of 1968, as amended in 1973, provides for a federally subsidized flood insurance program conditioned on active management and regulation of flood plan development by states and local governments. 42 U.S.C., §§4001 and 4128; 24 C.F.R., §1979.1-1925.14 (1975). Communities designated as flood prone by FEMA can obtain flood insurance eligibility for structures within the community upon meeting the qualifications of the act by developing a floodplain management system. Development of a floodplain management system requires the community to promulgate a land use and building permit system that restricts development in flood hazard areas. FEMA publishes a list, updated monthly, of the status of communities. Flood insurance is provided on a subsidized basis through all licensed insurance agents.

Federally regulated lending institutions (FDIC, ESLIC, NCUA) must require flood insurance for loans made on structures in FEMA-identified flood hazard areas in communities where flood insurance is available. The lender is required to give notice to the borrower 10 days in advance that the property securing the loan is located in a flood hazard area, and written acknowledgement of the borrower's knowledge of the flood hazard must be obtained. If flood insurance is not available in the community, the lender may still make the loan, but he or she must notify the borrower that federal disaster assistance may not be available in the event of a flood disaster. Federally insured loans (SBA, VA and FHA) have the same requirements, with the exception that they cannot be made on property located in a FEMA identified flood hazard area if flood insurance is not available in the community.

An area of great concern is whether flood hazard boundaries should be based on current development in the drainage watershed or on future development. FEMA uses current development as its criteria. UDFCD uses future development, which results in the regulation of a larger floodplain area in most instances. Although the watershed may take time to develop in accordance with the local government's Master Land Use Plan and land use requirements may call for on-site upstream detention, it is UDFCD's position that "future condition" criterion is preferable because existing floodplain users are put on notice of what the future may bring, and potential users of the floodplain are also put on notice of the potential hazard. The net result is a more restrictive regulation under 32-11-218 (1)(f) C.R.S. This section of the statute reads as follows: "To adopt, amend, repeal, enforce, and otherwise administer under the police power such reasonable floodplain zoning resolutions, rules, regulations, and orders pertaining to properties within the district of any public body or other person (other than the federal government) reasonably affecting the collection, channeling, impounding, or disposition of rainfall, other surface and subsurface drainage, and storm and flood waters (or any combination thereof), including without limitation variances in the event of any practical difficulties or unnecessary hardship and exceptions in the event of appropriate factors, as the board may from time to time deem necessary or convenient. In the event of any conflict between any floodplain zoning regulation adopted under this section and any floodplain zoning regulation adopted by any other public body, the more restrictive regulation shall control." With UDFCD being granted police powers it is granted discretion to adopt positions that have as their purpose the protection of life and property. Another example of UDFCD's exercise of its police powers is its position of privately owned detention facilities. UDFCD will not permit the recognition of those facilities unless there are written adequate assurances that the detention facility will not be modified in a way that it would reduce its flood control benefits.

### 5.3 Flood Warning Systems and Notification

UDFCD has adopted a procedure to notify known occupants of identified flood hazard areas (100-year floodplains). Although larger floods can and do occur, the local governments in Colorado are directed by the legislature to identify the areas that would be affected by 100-year storms. The CWCB has been directed by the legislature to coordinate this land use program.

UDFCD's "Flood Hazard Information Official Notice" also suggests actions that individuals can take to help themselves mitigate the hazard. This notice is mailed annually to the occupants of all residential units identified as being in the flood hazard area.

With the use of radar and a communications network, UDFCD has put in place a system to help inform all residents of UDFCD of potential flooding.

There is no legal requirement that UDFCD utilize any of these notification procedures. However, 32-11-220 (1)(c) C.R.S. provides that UDFCD has the power: "To carry on technical and other investigations of all kinds, make measurements, collect data, and make analyses, studies, and inspections pertaining to the facilities and any project, both within and without the district . . . ." Therefore, given the power to determine the location of 100-year floodplains and to gather information in regard to potential flooding; it follows that such information should be disseminated to the public.

As noted earlier, UDFCD, by reason of it taking on these tasks, does not assume any liability since it is protected under the Colorado Governmental Immunity Act.

## 6.0 Special Matters

### 6.1 Irrigation Ditches

In situations in which an irrigation ditch intersects a drainage basin, the irrigation ditch does not have to take underground waters diverted by a tile drain. However, the surface drainage must be accepted if the irrigation ditch is constructed in such a way that surface water would naturally flow into it. Clark v. Beuprez, 151 Colo. 119, 377 P.2d 105 (1962) (between private parties, the owner of an irrigation ditch can prevent an upstream landowner from diverting waters from their natural course into the irrigation ditch); City of Boulder v. Boulder and White Rock Ditch & Reservoir Company, 73 Colo. 426, 216 P. 553 (1923) (where an irrigation ditch was constructed in a natural drainageway into which surface water would naturally flow, the ditch owners could not complain merely on the ground that the city, in building storm sewers, collected the surface water and accelerated its flow and precipitated or discharged it at some particular point in the line of the ditch instead of spreading it out at different places of entrance).

In urbanizing areas, the conflict between the natural flow of surface water and irrigation ditches which bisect many drainage basins continues to be a difficult condition to resolve, taking into consideration the rights and liabilities of upstream property owners and irrigation ditch owners. Innumerable natural drainageways have been blocked by irrigation ditches, although they were constructed long before the basin became urbanized. This special area of urban drainage points to the need for good land use requirements, as well as identification of potential problem areas.

7-42-108 C.R.S. provides in part that:

Every ditch corporation organized under the provisions of law shall be required to keep its ditch in good condition so that the water shall not be allowed to escape from the same to the injury of any mining claim, road, ditch, or other property.

This provision of Colorado law was interpreted in the case of Oliver v. Amity Mut. Irrigation Co., 994 P.2d 495 (Colo. App. 1999). In this case, the ditch company was being sued for damages to property resulting from a break in the bank of the ditch company's ditch. The court held that the statute imposed a duty of ordinary care, such as a person of average prudence and intelligence would use, under like circumstances to protect his or her own property. The court went on to state that, in order for the ditch company to fulfill its statutory duty, it had to prevent erosion of the ditch bank, keep the ditch free of sediment and debris, and control the amount of water flowing through its ditch, among other things, keeping the spillway at the intersection of its ditch and another free of obstructions. Finally, the court concluded that, although a ditch company is not liable for damages caused solely by an act of God, the company may not escape liability if its negligence contributed to or cooperated with an act of God to cause the damage.

In conclusion, those that own ditches owe a duty to those property owners, whose property their ditches pass to maintain their ditches, using ordinary care so as to prevent damage to the adjoining real property.

## 6.2 Dams and Detention Facilities

Subdivision regulations adopted by the board of county commissioners must include provisions requiring subdivisions to submit:

Maps and plans for facilities to prevent stormwaters in excess of historic runoff, caused by the proposed subdivision, from entering, damaging, or being carried by conduits, water supply ditches and appurtenant structures, and other storm drainage facilities. 30-28-133 (3)(c)(VIII) C.R.S.

In addition, the regulations must include provisions governing:

Standards and technical procedures applicable to storm drainage plans and related designs, in order to ensure proper drainageways, which may require, in the opinion of the board of county commissioners, detention facilities which may be dedicated to the county or the public, as are deemed necessary to control as nearly as possible, stormwaters generated exclusively within a subdivision from a one-hundred year storm which are in excess of the historic runoff volume of stormwater from the same land area in its undeveloped and unimproved condition. 30-28-133 (4)(b) C.R.S. See Shoptaugh v. Board of County Commissioners, 543 P.2d 524 (Colo. App. 1975).

The law in regard to liability for damages caused by failure of a dam or detention facility has changed. In the case of Kane v. Town of Estes Park, 786 P.2d 412 (Colo. 1990), the Colorado Supreme Court considered the issue of whether the Town of Estes Park was negligent for the failure of its dam and reservoir, which was the result of the failure of an upstream dam. The court held that "To impose a burden on a downstream builder to construct facilities adequate to hold or bypass the entire capacity of an upstream reservoir has the potential for foreclosing construction of beneficial downstream storage facilities because of prohibitive costs." The court then concluded as follows:

In summary, we hold that public entities that own dams or reservoirs are not subject to strict liability for damages caused by water escaping from their dams or reservoirs.

Furthermore, we hold that Estes Park had no duty to ensure that waters released from an upstream reservoir because of a dam failure of this magnitude would be contained by its facilities or would bypass those facilities without augmentation.

The Colorado legislature, in response to the 1982 flood that then resulted in the above-referenced lawsuit, amended the statute in regard to storage reservoirs to clarify the law. The applicable sections of 37-87-104 C.R.S. read as follows:

1. Any provision of law to the contrary notwithstanding, no entity or person who owns, controls, or operates a water storage reservoir shall be liable for any personal injury or property damage resulting from water escaping from that reservoir by overflow or as a result of the failure or partial failure of the structure or structures forming that reservoir unless such failure or partial failure has been proximately caused by the negligence of that entity or person. No entity or person shall be required to pay punitive or exemplary damages for such negligence in excess of that provided by law. Any previous rule or law imposing absolute or strict liability on such an entity or person is hereby repealed. See also East Meadows Company, LLC v. Greeley Irrigation Company, 99 P.3d 214 (Colo. App. 2003).
2. No such entity or person shall be liable for allowing the inflow to such reservoir to pass through it into the natural stream below such reservoir.

The law therefore is relatively clear now in regard to the ownership of dams and reservoirs and the owner's liability for them. No longer are dam owners subject to strict liability for damages caused by those dams. Meaning, that now in order to hold a dam owner responsible for damage caused by the dam, it must be established that the dam owner was negligent in maintenance or operation of the dam. However, this test of negligence is further limited by the law's permission to dam owners to pass all inflows through the dam.

The court, in the case of Barr v. Game, Fish and Parks Commission, 497 P.2d 340 (Colo. App. 1972), held that the criteria for the construction of a dam is to safely pass the probable maximum precipitation (PMP). In Barr, the Colorado Court of Appeals found that, since modern meteorological techniques provide a method of predicting the probable maximum storm and flood, liability should be imposed for injuries resulting from a failure to determine the probable maximum flood and to design and construct a dam with a spillway having the capacity to handle that storm. The court stated:

The maximum probable storm, by definition, is both maximum and probable. It can and may occur... Thus being both predictable and foreseeable to the defendant in the design and construction of the dam, the defense of act of God is not available to them.

However, the Colorado State Engineer, pursuant to 37-87-105 (1) and (3) C.R.S. must approve plans and specifications for the alteration, modification, repair, or enlargement of a jurisdictional reservoir or dam and, pursuant to regulation, may impose less stringent requirements than those dictated by consideration of the PMP. In fact, the Colorado State Engineer has issued *Rules and Regulations for Dam Safety and Dam Construction*, 2 CCR 402-1 (September 1988) wherein at Rule 4 dams are classified based upon an evaluation of the consequences of the failure of the dam absent of flooding conditions. Based upon that classification, Rule 5 sets forth the inflow design flood to be used in determining the spillway capacity of that dam.

A question arises, however, regarding the proper criteria to use in determining the size of the floodplain or channel below the dam: the 100-year flood, before the dam was constructed or after construction? This special area has not been resolved by either the legislature or the courts in Colorado. However, since some dams and reservoirs are required by law to safely pass the PMP (storms greater than the 100-year

storm) it might be argued that the watercourse below the dam should be constructed to at least carry the same water as before construction of the dam. Assuming the dam safely passes a 500-year flood, for example, the 100-year floodplain would obviously be inadequate. But with no dam in place, the same floodplain would also be inadequate.

30-28-133 (4)(b) C.R.S. provides: “Standards and technical procedures applicable to storm drainage plans and related designs, in order to ensure proper drainage ways, which may require, in the opinion of the board of county commissioners, detention facilities which may be dedicated to the county or the public, as are deemed necessary to control, as nearly as possible, stormwaters generated exclusively within a subdivision from a one hundred year storm which are in excess of the historic runoff volume of stormwater from the same land area in its undeveloped and unimproved condition ....” Therefore, based upon this statute as well as accepted engineering design standards, if it is possible to design a facility based upon a 100-year storm frequency and to limit development in a 100-year floodplain, that should occur.

Preserving the 100-year floodplain before the dam was constructed, where possible, is prudent and will lessen damage below the newly constructed dam in the larger than 100-year storm, although not for the PMP.

### 6.3 Stormwater Management and Water Law

Stormwater runoff is a major non-point source of water pollution. In urbanizing areas, where land-disturbing activities are numerous, stormwater washes soil and sediment into surface waters causing increased levels of turbidity and eutrophication, threatening fish and wildlife, and blocking drainage. In developed areas, runoff carries with it the pollutants from surfaces over which it runs, including, oil, litter, chemicals, nutrients and biological wastes, together with soils eroded from downstream channels of the flow. U.S. Environmental Protection Agency, *Legal and Institutional Approaches to Water Quality Management Planning and Implementation*. VI-I (1977).

It is reasoned that water quality control should be an integral part of any drainage or stormwater management program, since stormwater management techniques are often consistent with water quality objectives. However, this special area, as related to urban drainage, has not been researched adequately enough so as to provide the facts upon which a cost-effective approach could integrate water quality objectives with plans for surface drainage improvements. See City of Boulder v. Boulder and White Rock Ditch & Reservoir Company, 73 Colo. 426, 216 P. 553, 555 (1923).

Currently, counties and municipalities are under regulation through the U.S. Environmental Protection Agency and the State of Colorado to address water quality issues. Volume 3 of the USDCM deals in detail with those requirements.

Water quality has become an integral part of each and every drainage and flood control facility that is being constructed in the United States. Some of the emerging issues in regard to water quality are numeric effluent limits, TMDLs (total maximum daily loads) and LID (low impact development). Although it is not the purpose of this section of the USDCM to address these issues from an engineering standpoint (See Volume 3), it is important to note their existence and, in some cases, their unintended consequences.

In the case of the EPA’s regulation of numeric effluent limits, as a result of litigation, the EPA has agreed to withdraw the numeric turbidity effluent limitation and monitoring requirements and to add a definition of “infeasible” recognizing that there can be a site-specific constraint that makes it technically infeasible

to implement the effluent limits, or that implementing the requirement would be cost-prohibitive.

In regard to TMDLs, the EPA has identified the total pollutant loading that a waterbody can receive and still meet water quality standards, and specifies a pollutant allocation to specific point and nonpoint sources. The difficulty in meeting the TMDL standards is designing a system that addresses those standards without impacting the water rights of others.

LID practices include BMPs that divert and consume rain water (e.g., bioretention facilities, rain gardens, green roofs, and rain barrels). The problem with each of these, especially in the arid West, is that in some cases they may impact on a water right owned by others. If such an issue is raised by either the state or a water rights owner, the impact could cause the use of certain BMPs to become uneconomical. In addition, consideration should be given to the design of certain BMPs when located close to other structures so as to avoid a claim of damage to those adjacent structures by reason of the detained water.

Colorado laws are so strict that even when a pilot program was approved by the Colorado General Assembly (37-60-115 C.R.S.) permitting the collection of precipitation from rooftops and impermeable surfaces for nonpotable uses, the participants were required to replace the water that was captured by those means.

On May 11, 2011 the Colorado Department of Natural Resources Division of Water Resources issued a Memorandum in regard to stormwater management. It required that all detention and/or infiltration facilities that are used for managing stormwater quality and volume of discharge must release all of the water detained from the site within 72 hours of the end of the precipitation event. In regard to green roofs, those may only intercept precipitation that falls directly onto the landscaping and the green roof may not intercept and consume concentrated flow and may not store water below the root zone. This memorandum only applied to individual sites and did not provide legal protection. In 2014, UDFCD requested the same administrative allowance for regional installations and was denied. UDFCD, with support from communities within the region, sought legislation to provide legal protection for both individual and regional water quality and flood control facilities.

In May 2015, Senate Bill 15-212 was signed into law by Governor Hickenlooper and became effective August 5, 2015 as Colorado Revised Statute (CRS) 37-92-602 (8). The statute provides legal protection for any regional or individual site stormwater detention and infiltration facility in Colorado except those in the Fountain Creek watershed that are not required by or operated in compliance with an MS4 permit, provided meets the following criteria:

1. It is owned or operated by governmental entity are subject to oversight by a governmental entity (e.g., required under an MS4 permit);
2. It continuously releases or infiltrates at least 97 percent of all the runoff from a rainfall event that is less than or equal to 85 year storm within 72 hours after the end of the event;
3. It continuously releases or infiltrates as quickly as practicable, but in all cases releases or infiltrates at least 99 percent of the runoff within 120 hours after the end of events greater than a five year storm; and
4. It operates passively and is not subject this storm water runoff to any active treatment process(e.g., coagulation, flocculation, disinfection, etc.).

## 6.4 Professional Responsibility

The Colorado Rules of Professional Conduct of the State Board of Registration for Professional Engineers and Professional Land Surveyors provides in the *Basis and Purpose* section the following:

In order to safeguard life, health and property, to promote the public welfare, and to establish and maintain a high standard of integrity and practice, the following Rules of Professional Conduct shall be binding on every person holding a certificate of registration and on all partnerships or corporations or other legal entities authorized to offer or perform engineering or land surveying services in Colorado.

These Rules were authorized by Colorado statute and in 12-25-108 (1) C.R.S.

The board has the power to deny, suspend, revoke, or refuse to renew the license and certificate of registration of, limit the scope of practice of, or place on probation, any professional engineer or engineer-intern who is found guilty of:...(e) Violating, or aiding or abetting in the violation of,...any rule or regulation adopted by the board in conformance with the provisions of this part 1,...Rule I—Registrants shall hold paramount the safety, health and welfare of the public in the performance of their professional duties.

2. Rule I shall include, but not be limited to, the following:

- A. Registrants shall at all times recognize that their primary obligation is to protect the safety, health, property and welfare of the public. If their professional judgment is overruled under circumstances where the safety, health, property or welfare of the public are endangered, they shall notify their employer or client and/or such other authority as may be appropriate.

Based upon the law and rule set forth above, a professional engineer is required not only to serve the interests of his or her employer/client but is also required as a primary obligation to protect the safety, health, property, and welfare of the public. Therefore, this obligation of protection is superior to the obligation to an employer/client and therefore must be considered in all professional decisions made by a professional engineer. Therefore, an engineer is required even if there is no law or regulation being violated to act to protect the safety, health, property, and welfare of the public in regard to any portion of a project in which the engineer is involved. In addition, a goal of an engineer should also be to report to an appropriate authority any condition on a project that jeopardizes the safety, health, property, or welfare of the public even if that condition is not his or her responsibility.

## 6.5 Professional Liability

For those practicing a profession requiring specialized knowledge or skill, reasonable care requires the actor to possess "a standard minimum of special knowledge and ability" and to exercise reasonable care "in a manner consistent with the knowledge and ability possessed by members of the profession in good standing." Rian v. Imperial Municipal Services Group, Inc., 768 P.2d 1260 (Colo.App.1989). This statement of the law applies to engineers in the State of Colorado.

Specific suggestions for design engineers to reduce their liability in regard to drainage-related work include the following:

- Check projected peak flows for reasonableness using multiple methods.
- Check for evidence of historic flooding.
- Make sure to coordinate design work with all applicable local governments and potentially other affected parties, such as railroads, highway departments, adjoining public and private property owners, and others.

- Be very sure of what local, state and federal regulations apply, and bring all of them to the attention of the project applicant.
- Assure that there is an adequate drainage outfall for runoff from the development.
- Be careful about changing the historic drainage status quo—carefully examine upstream and downstream implications.
- Bring in special assistance when merited.
- Stay abreast of new laws, regulations, policies, news events, etc., in the areas in which one is practicing.<sup>2</sup>

## 6.6 Miscellaneous Issues

1. Reliance on others' work in performing engineering services including relying on FIRM maps prepared by FEMA. An engineer is not required to re-perform another's work upon which the engineer relies. However, an engineer should critically review the work to determine if there are any obvious errors.
2. Reliance on local governments in regard to the National Flood Insurance Program. The NFIP is a Federal program created by Congress to mitigate future flood losses nationwide through sound, community-enforced building and zoning ordinances and to provide access to affordable, federally backed flood insurance protection for property owners. In support of the NFIP, FEMA identifies flood hazard areas throughout the United States and its territories. Most areas of flood hazard are commonly identified on Flood Insurance Rate Maps (FIRMs). An engineer should always check the FEMA National Flood Insurance Program Community Status Book to determine whether the community that the engineer is working in has been put on probation, suspended for failure to enforce or withdrawn from the NFIP. If so, caution should be exercised in regard to reliance on the community to enforce the FIRMs applicable to that community.
3. The Urban Drainage and Flood Control District Board is given broad powers in regard to the adoption of master plans. "To adopt, amend, repeal, enforce, and otherwise administer under the police power such reasonable floodplain zoning resolutions, rules, regulations, and orders pertaining to properties within the district of any public body or other person (other than the federal government) reasonably affecting the collection, channeling, impounding, or disposition of rainfall, other surface and subsurface drainage, and storm and flood waters (or any combination thereof), including without limitation variances in the event of any practical difficulties or unnecessary hardship and exceptions in the event of appropriate factors, as the board may from time to time deem necessary or convenient. In the event of any conflict between any floodplain zoning regulation adopted under this section and any floodplain zoning regulation adopted by any other public body, the more restrictive regulation shall control." 32-11-218 (1)(f)(I) C.R.S. As noted in the last sentence of the statute, the more restrictive floodplain boundary will always apply in these matters. In addition, as long as master plans whether adopted by UDFCD or any other governmental entity

---

<sup>2</sup> Jonathan E. Jones, P.E., D.WRE



are adopted during a legislative process with public notice, the challenge to those master plans will most likely be unsuccessful due to Colorado law (29-20-203 C.R.S.)

4. If a developer constructs onsite detention but the same is not recognized by UDFCD or another governmental entity, is the developer afforded legal protection from downstream property owners? Whether UDFCD or another governmental entity recognizes a private onsite detention facility, has no bearing on a developer's potential legal liability to downstream property owners. The test, in this case, is whether the discharge from the development is in a manner or quantity to do more harm than formerly downstream. If it is, the developer would be liable for that damage. If it is not, the developer would not be liable to downstream property owners. Hankins v. Borland, 431 P.2d 1007 (Colo. 1967).
5. Engineers should be aware that just following the USDCM or similar manual adopted by a governmental entity in their design efforts might not be enough to meet all of the governmental regulations applicable to the design. For example, zoning ordinances and subdivision regulations, or similar documents may be applicable to the design being prepared. Checking with the governmental department in the community where the structure is to be built usually will provide the engineer with information in regard to all standards that need to be complied with in regard to the design.
6. Changing historic drainage capacity must be carefully analyzed in regard to the impact on both upstream and downstream property owners. If the capacity of a culvert is being increased, before that increase takes place, adequate sizing increases of facilities downstream must take place to accommodate those increased flows otherwise liability to downstream property owners damaged by that increase may occur. Scott v. City of Greeley, 931 P.2d 525 (Colo.App. 1996).
7. Drainage and flood control structures once constructed should be maintained so as to function over the years as designed. Understanding the importance of maintaining UDFCD constructed infrastructure, the Colorado General Assembly added the ability for UDFCD to levy up to one-half mill for these expenses. This ability was added to the UDFCD statute and covers operation and maintenance expenses. The failure to maintain drainage and flood control structures can lead to damage to property and injury or death of individuals. An example of this would be the failure of pipe under a highway while automobiles are travelling on the highway. Not only may the highway be damaged, but the traveling public may be injured due to collapse of the highway.
8. Prior to Colorado law changing in regard to liability of governmental entities for drainage and flood control facilities that they construct, operate and maintain (See Section 1.2 2. of this chapter), governmental entities were found legally responsible for injuries and deaths that occurred in those facilities. In the case of City of Longmont v. Henry-Hobbs, 50 P.3d 906 (Colo. 2002) the Colorado Supreme Court found that a city is liable for a death that occurred in an artificial irrigation ditch of which the city is a shareholder and which is an integral part of the city's storm drainage system. The spillway in which a child drowned was constructed for and adopted by the city as part of the use of the ditch and the alleged negligence related to the design of this spillway. The Court held that thus, his death may have resulted from the operation and maintenance of a sanitation facility.

In a companion case, the Colorado Supreme in the case of City of Colorado Springs v. Powell, 49 P.3d 561 (Colo. 2002) held the city may have been negligent in failing to post warning signs that would have alerted a passersby to the danger of the ditch. Further, the Court held the city may have been negligent in constructing the ditch with steep concrete sides that make it difficult to escape.

Although, governmental entities may be immune from liability in regard to drainage and flood control facilities, this immunity does not extend to privately owned drainage and flood control facilities.

## 7.0 Conclusion

The force of gravity, which causes all waters flowing on the earth to seek the lowest level, creates natural drainage and provides for the distribution of all water, whether surface or otherwise. This natural drainage is necessary to render the land fit for the use of man.

The streams are the great natural sewers through which the surface water escapes to the sea, and the depressions in the land are the drains leading to the streams. These natural drains are ordained by nature to be used and, so long as they are used without exceeding their natural capacity, the owner of land through which they run cannot complain that the water is made to flow in them faster than it does in a state of nature. 2 Farnham, Water and Water Rights, p. 968.

Drainage is both simple and complicated. If the facts are ascertained and a plan is developed before initiating a proposed improvement, the likelihood of an injury to a landowner is remote, and the municipality or developer should be able to undertake such improvements relatively assured of no legal complications and be able to use several different means of financing the improvement.

An engineer designing drainage improvements should consider the following:

1. Walking the site or watershed under study.
2. Whether there are existing problems and what causes them (obstructions, topography, development, present or future).
3. Whether proposed improvements will make the situation better.
4. Whether the proposed improvements require or result in changes to the natural drainage patterns.
5. Whether there is potential liability for doing something versus doing nothing.
6. Who will benefit from the proposed improvements?
7. If what is proposed is “reasonable,” using the criteria set forth in paragraph 2.1.3.



# Chapter 3

## Planning

### Contents

<b>1.0</b>	<b>Importance of Drainage Planning .....</b>	<b>1</b>
1.1	Planning Philosophy.....	2
1.2	Elements of Early Drainage Planning .....	3
<b>2.0</b>	<b>Minor (Initial) Drainage System Planning.....</b>	<b>4</b>
<b>3.0</b>	<b>Drainage Master Planning Process.....</b>	<b>5</b>
3.1	General.....	5
3.2	Types of Drainage Plans .....	7
3.2.1	Major Drainageway Planning Studies.....	7
3.2.2	Outfall Systems Planning Studies .....	7
3.3	Phases of Planning .....	8
3.3.1	Baseline Hydrology.....	8
3.3.2	Alternatives Analysis .....	9
3.3.3	Conceptual Design .....	11
3.4	Alternative Plan Components.....	12
3.4.1	Conveyance.....	12
3.4.2	Stabilization .....	13
3.4.3	Acquisition of Flood-prone Properties or Structures .....	14
3.4.4	Crossing Structures .....	14
3.4.5	Detention (Storage).....	15
3.4.6	Water Quality.....	16
<b>4.0</b>	<b>Floodplain Management .....</b>	<b>16</b>
<b>5.0</b>	<b>Multi-use Opportunities .....</b>	<b>19</b>
<b>6.0</b>	<b>References .....</b>	<b>21</b>



## 1.0 Importance of Drainage Planning

Planning the urban storm runoff system is fundamental for protection of public health, safety, welfare and the environment. The urban storm drainage system is a subsystem of the total urban infrastructure system and should be integrated with other subsystems including transportation, parks, open space, and utilities. When properly planned in concert with other subsystems, the storm drainage system can provide multiple benefits to urban communities. Effective planning requires an understanding of both urban and drainage planning, as well as the many social, technical, and environmental issues specific to each watershed.



**Photograph 3-1.** Bible Park with fully integrated drainage, flood control, recreation, and open space functions represents a partnership among engineers, landscape architects, planners, and parks and recreation professionals.

Drainage engineers should be included in urban planning from the beginning. Conducting drainage planning after decisions are already made regarding the layout of a new subdivision, commercial area or the transportation network often leads to costly and difficult drainage solutions and urban space allocation problems. When included early in the planning process, drainage engineers are able to work with the planning team to maximize benefits from drainage systems, including amenities such as recreation and open space. Consideration of multiple uses and benefits in drainage planning and engineering can reduce drainage costs and increase benefits to urban communities.

Urban Drainage and Flood Control District (UDFCD) has been engaged in drainage master planning for watersheds and streams in the metropolitan Denver area since the early 1970s. During the planning process, planners and engineers evaluate hydrology and identify important constraints, areas of open space preservation, needs for easements, opportunities for recreation and other multi-use opportunities, and means of accommodating utility conflicts. The team will develop design alternatives for locations and types of structures and facilities while also evaluating the suitability, type, and location of detention basins and water quality facilities. This is also a good time to identify opportunities and criteria to decrease the effective imperviousness of the built watershed through minimizing directly connected impervious areas. The planning process includes active participation by sponsoring municipalities, UDFCD and other regulatory stakeholders and includes public meetings and outreach to obtain community stakeholder input. Through public input and technical analysis, alternatives are vetted to make decisions and arrive at a conceptual plan for the system that is technically and politically feasible.

## 1.1 Planning Philosophy

Urban drainage planning should proceed on a well-organized basis with a defined set of drainage policies supported by local ordinances. The policies, objectives and criteria presented in this manual provide a foundation on which additional local policies can be built. Many local ordinances and municipal stormwater permits incorporate the criteria in the Urban Storm Drainage Criteria Manual (USDCM) by reference.

Drainage must be integrated early into the fabric of the urban layout, rather than be superimposed onto a development after it is laid out. The planning and design team should think in terms of natural drainage easements and street drainage patterns and should coordinate efforts with the drainage engineers to follow the policies and achieve the objectives presented in the USDCM.

Urban drainage planning should address three key components:

1. **Minor (Initial) Drainage System:** As defined in the *Policy* chapter, the minor (or initial) drainage system includes conveyances such as grass swales, streets and gutters, storm drains, and roadside ditches. It may also include conveyance and storage-based water quality facilities. If the initial drainage system is properly planned and designed, complaints from the community related to localized flooding and drainage nuisance conditions will be reduced. A well-planned initial drainage system provides for convenient drainage, reduces costs of streets, and minimizes disruptions to the function of urban areas during runoff events.
2. **Major Drainage System:** A well-planned major system protects the urban area from extensive property damage, injury, and loss of life from flooding. The major system exists in a community whether or not it has been planned and designed and regardless of whether development is situated wisely with respect to it. General principles that UDFCD has recognized in planning for the major drainage system include:
  - Water will obey the law of gravity and flow downhill regardless of whether buildings, roads and people are in its way.
  - Targeted stabilization (e.g., grade control, toe protection and other measures) before a stream begins to degrade is generally far more cost effective and environmentally beneficial than a reactive approach addressing channel stability/restoration after significant degradation has occurred.
  - The practice of straightening, narrowing, and filling natural watercourses comes at a high environmental cost. This practice also increases velocities and typically results in high maintenance costs.

### A Resource in Place

The urban stormwater planning process should attempt to make drainage, which is often a “resource out of place,” a “resource in place” that contributes to the community’s general wellbeing.

### Importance of Drainage Planning

Storm runoff will occur when rain falls or snow melts, no matter how well or how poorly drainage planning is done. Drainage and flood control measures are costly when not properly planned. Good planning results in lower-cost drainage facilities for the developer and the community and more functional community infrastructure.—D. Earl Jones, 1967

3. **Floodplain Management:** Floodplain management is closely tied to major drainage systems. Nature's prescriptive floodplain easements along streams and rivers should be maintained using tools including floodplain/floodway delineation, floodplain regulation, open space preservation and zoning. Small waterways and gulches lend themselves to floodplain regulations in the same manner as larger creeks.

For all three of these components, drainage system planning that best serves the community follows natural drainage patterns.

## 1.2 Elements of Early Drainage Planning

The drainage engineer, planner, and the entire planning team should work in close cooperation, recognizing that good urban drainage planning is a complex process. Early drainage planning should include these elements and guiding principles:

1. Address fundamental drainage features and objectives, including the major drainage system, initial drainage system, stormwater water quality management, multi-use objectives, and the environment.
2. Street conveyance is an important part of the minor (initial) drainage system. For new subdivision planning, evaluate various conceptual drainage alternatives before decisions are made regarding street location and layout.
3. Consider the level of flood hazard in the planning area. Protect public safety and avoid unnecessary complications with local planning boards and governments.
4. Don't compromise on drainage in a new development to increase short-term profits. Long-term community interests will suffer as a result. Both governmental and private planners are encouraged to confer and work with drainage engineers.
5. Address federal, state and local regulatory requirements early in the planning process. Drainage projects will frequently trigger the need for environmental permits required under federal, state and/or local water quality regulations (e.g., disruption of wetlands, riparian setback ordinances). For some

### Benefits of a Well Planned Drainage System

An urban area with well-planned drainage facilities is usually an area that experiences orderly growth and realizes benefits such as:

1. Fewer downstream constrictions and increased conveyance capacity for upstream property owners.
2. Better managed runoff, less pollution entering stormwater, and more stable waterways.
3. Improved water quality.
4. Protection and enhancement of environmentally sensitive areas.
5. Reduced street maintenance costs.
6. Reduced street construction costs.
7. Improved traffic movement.
8. Improved public health and environment.
9. Lower-cost park and open space areas and more recreational opportunities.

### Nature's Floodplain Easement

On any floodplain, nature possesses, by prescription, an easement for intermittent occupancy by runoff waters. Man can deny this easement only with difficulty. Encroachments upon or unwise land modifications within this easement can adversely affect upstream and downstream flooding occurrences during the inevitable periods of nature's easement occupancy.—Gilbert White, 1967



permits and approvals (e.g., CLOMRs, individual 404 permits, threatened and endangered [T&E] species), the review period can be lengthy. A solid understanding of applicable regulatory permits and requirements is imperative because these requirements can significantly affect the design, construction and long-term maintenance of channels, ponds, wetlands, and other facilities.

## 2.0 Minor (Initial) Drainage System Planning

For the area served by UDFCD, the minor (initial) storm is defined to have a return frequency of once every 2- to 10-years. The minor drainage system is needed to convey flows from the initial design storm to reduce inconvenience, frequently recurring damages, and street maintenance costs, and to help create an orderly urban system with a multi-functional drainage system. The initial system may include a variety of features such as swales, curbs and gutters, storm drain pipes, on-site detention, runoff reduction (e.g., minimized directly connected impervious areas) practices, and water quality BMPs. Generally, the initial drainage system drains a tributary no larger than 130 acres, as the runoff from this area would be in excess of the typical capacity of these features within a street section. The initial system exists with or without storm drains. Storm drains are needed when the other parts of the initial system no longer have capacity for additional runoff. A good major drainage system coupled with wise layout of streets can often significantly reduce the need for storm drains. The *Policy* chapter and the *Streets, Inlets and Storm Drains* chapter of this manual provide policies, criteria and procedures for designing the initial drainage system, including criteria related to streets as part of the initial drainage system. The discussion in the remainder of this section is limited to planning-level considerations.



**Photograph 3-2.** UDFCD drainage criteria are aimed at respecting the needs of safe, unimpeded traffic movement. This intersection represents a long-standing drainage problem needing a solution.

The preliminary layout of a storm drainage system should consider urban drainage objectives, hydrology, and hydraulics. The preliminary layout of the system has more effect on the success and cost of the storm drains than the final hydraulic design, preparation of the specifications, and choice of materials. For this reason, preliminary work on the layout of the storm drains should occur prior to finalizing street layout in a new development. Once the street layout is set, options to provide a more cost-effective system are greatly reduced. Various layout concepts should be developed and reviewed, and critical analyses should be done to arrive at the best layouts. For example, the longer that street flow can be kept from concentrating in one street, the further gutters or swales can be used for conveyance. This will reduce the length of pipe required. In storm drain design, it is important to remember that small-diameter laterals represent a large part of the total construction cost. A key planning objective should be the design of a balanced system in which all portions will be used to their full capacity without adversely affecting the drainage of areas served by the system. See the *Streets, Inlets, and Storm Drains* chapter for limitations of street flow.

Another fundamental planning consideration for the initial system is the runoff or rainfall return period for designing a storm drain system required by local governments. Whenever the system crosses jurisdictional boundaries, differences in sizing policies for the initial system must be coordinated so that a consistent design is achieved for the entire system. Once the overall design return period has been

established, the system should be reviewed for points where deviation is justified or necessary. A drainage area must be reviewed on the basis of both the initial and the major storm occurrence. When analysis implies that increasing the storm drain capacity is necessary to help convey the major storm, the basic system layout of the major drainage should be analyzed and changed, as necessary. For example, in a sump area that has no other method of drainage, it may be necessary to plan for a storm drain to receive more than the initial runoff.

## 3.0 Drainage Master Planning Process

### 3.1 General

Drainage master plans provide guidance for drainage and flood control related improvements for all or part of an evolving watershed, often crossing jurisdictional boundaries and incorporating public participation. Drainage master plans are most effective when sound hydrologic and hydraulic engineering analysis is coordinated with planning for open space, recreation, transportation, water quality, urban wildlife, and other considerations. Master plans are important tools to help identify capital projects for construction by local governments. Master plans also help guide new land development projects to be consistent with regional drainage and stormwater quality needs and help to identify and acquire land and rights-of-way for future capital improvements, drainageway maintenance, and floodplain preservation. Master plan recommendations can be remedial (correcting existing problems) and/or preventive. The drainage master planning process is based on a two-pronged approach:

1. **Preserve:** Where development has not yet occurred, preservation of existing drainage features and associated floodplains in a manner that preserves natural flow paths, ecological benefits and natural floodplains is preferred.
2. **Mitigate:** Both historic and future development may require mitigation of the impacts of urbanization through improvements that stabilize or restore stream channels, detain increased runoff volumes, and improve conveyance.

An effective drainage master planning process typically begins with research and data collection, and

#### **UDFCD's Master Planning Program**

The Master Planning Program produces drainage master plans based on the following four key policy decisions which guide the program implementation:

1. Each master planning effort must be requested by the local governments and should have a multi-jurisdictional aspect;
2. Master plans are completed by consultants acceptable to all local project sponsors and UDFCD;
3. UDFCD will pay up to 50% of the study costs, with the local sponsors sharing the remainder of the costs; and
4. The master plan must be acceptable to all the affected local governments.

Master plan recommendations can be remedial or preventive and are important for identifying projects for construction. The master plans also provide valuable input to UDFCD's Five-Year Capital Improvement Program. They help new land development projects to be consistent with regional drainage and stormwater quality needs and help to identify and acquire land and rights-of-way for future capital improvements, for stream management, and for floodplain preservation.

ends with a solid conceptual design plan for future improvements that addresses multiple stakeholders' needs and can be used as a reference document for the future. The process includes technical analysis, engineering calculations, agency and public coordination, attention to the environment, and the use of sound judgment and common sense. The planning process generally includes the following tasks:

- Collection and evaluation of available reports and studies on existing drainage facilities, zoning and land ownership plans, current and future land use plans, soils information and other drainage related information.
- Coordination and meetings with the project sponsors and stakeholders.
- Performance of a site investigation to identify major drainage structures, existing problem locations and hydrologic and hydraulic parameters.
- Development of hydrology for the existing and proposed future watershed conditions, including runoff volumes and flow rates for various return periods of flooding along streams.
- Estimation of the flooding potential to properties throughout the watershed.
- Evaluation of the hydraulic capacity of the existing drainage system and facilities.
- Development of stormwater infrastructure alternatives that address stakeholders' future needs.
- Evaluation of alternatives based on criteria, estimated construction costs, potential flooding, planning constraints and/or other related issues.
- Providing a recommended plan to the project stakeholders and the affected communities.
- Determining a final selected plan for future improvements based on feedback from the stakeholders and communities.
- Preparation of the Major Drainageway Plan or Outfall System Plan and development of conceptual design documents.

#### **Shelf Life**

Drainage master plans typically have a shelf life of 20 to 30 years, gradually becoming outdated due to changes in philosophy, policy, and/or planning. They lay the foundation for development while allowing some flexibility for the design phase of developments within a watershed. Urban land development in general accordance with the master plan does not give cause to update the master plan.

## 3.2 Types of Drainage Plans

UDFCD works with local project sponsors to implement two types of drainage plans: Major Drainageway Planning Studies and Outfall Systems Planning Studies, as described below.

### 3.2.1 Major Drainageway Planning Studies

Major Drainageway Planning Studies (MDPs) are based on hydrologic analyses from CUHP and SWMM and on hydraulic analyses from HEC-RAS. These studies generally focus on the main stem of the stream, identifying a floodplain and making recommendations to mitigate the flood hazard, as well as to improve the safety and function of the stream. These studies are often completed in conjunction with a Flood Hazard Area Delineation (FHAD) studies. Improvements evaluated may include:

- Channel enlargement and/or stabilization of channel banks and bottom.
- Longitudinal grade control of channel invert.
- Crossing structure improvements.
- Floodplain preservation.
- Detention for flood mitigation.
- Acquisition of flood prone properties.
- Water quality protection strategies and treatment facilities.
- Restoration of a natural stream system.
- Maintenance access.

A benefit-cost analysis is performed for reaches where structures are identified in the 100-year floodplain to assist in the alternative selection process. The benefit is primarily measured in reduced flood damages to existing structures as a result of recommended improvements, though it is important to also identify other intangible (or at least difficult to value) benefits like improved water quality, reduction/elimination of street flooding, public safety, aesthetics, and recreation (either active recreation such as organized sports and individual exercise, or passive recreation which may simply entail being in the open space). Time spent in an urban open space for recreation offers the healthful benefit of an aesthetic and psychological reprieve from the urban environment.

### 3.2.2 Outfall Systems Planning Studies

Outfall Systems Planning Studies (OSPs) are also based on hydrology from CUHP and SWMM but utilize only limited hydraulic analyses (no HEC-RAS). These studies only rarely identify a regulatory floodplain. OSPs typically focus on a watershed tributary to a large waterway that may have its own MDP. Typical types of analyses and proposed improvements may include:

- Detention for flood mitigation.
- Water quality protection strategies and treatment facilities.

- Storm drain system improvements.
- Crossing improvements.
- Channel enlargement and/or stabilization.
- Floodplain preservation.
- Maintenance access.

### 3.3 Phases of Planning

UDFCD's planning process proceeds in a standardized, orderly sequence, which includes three phases: 1) Baseline Hydrology, 2) Alternatives Analysis and 3) Conceptual Design. UDFCD provides standardized checklists (see [www.udfcd.org](http://www.udfcd.org)) for completion of each phase of the planning process, along with specific guidelines for electronic deliverables and mapping. Each of these phases is discussed below.

#### 3.3.1 Baseline Hydrology

Baseline hydrology defines the storm runoff volumes and peak flow rates for the 2-, 5-, 10-, 25-, 50-, and 100-year storm events under existing and proposed future build-out conditions. These runoff volumes and peak flow rates are used to evaluate the sufficiency of existing drainage facilities, identify potential drainage problems, and evaluate alternative drainage improvements. Two computer models are typically used to estimate baseline hydrology:

1. The Colorado Urban Hydrograph Procedure (CUHP): This model is used to calculate runoff for each catchment in a watershed for the 2-, 5-, 10-, 25-, 50-, and 100-year storm events. CUHP considers physical characteristics of each sub-watershed including shape, slope, impervious area, and soil conditions. See the *Runoff* chapter for a full description of CUHP.
2. The EPA Stormwater Management Model (SWMM): SWMM is used to route runoff from sub-catchments through the drainage system. Hydrograph routing considers the characteristics of conveyance elements, certain flood detention facilities, flow diversion conditions where existing storm drains cause flows to diverge from overland flow paths, and other factors.

Other models or techniques can be used to develop the baseline hydrology for MDPs and OSPs, but the CUHP and SWMM models are often preferred due to the size and complexity of study areas, degree of spatial variation in development and land-use within watersheds, and compatibility with UDFCD standards. Existing conditions used in these models are typically documented by a combination of field visits and Geographic Information System (GIS) analysis of data provided by local governments, such as imperviousness, land use, transportation infrastructure, soil types, slopes, and other features. Future conditions hydrologic analysis is completed based on future land use data from local governments, typically in the form of adopted zoning or comprehensive plans.

When developing existing and future hydrology, only detention facilities that are municipally-owned and operated and/or those with assurances for perpetual operation and maintenance are recognized in the modeling (i.e., most privately owned on-site detention and inadvertent detention are not considered in the modeling). This results in a model that conservatively bases runoff volumes and flow rates on only those flood control facilities that have a high probability of proper future maintenance and function.

Within the UDFCD planning area, master plans are often updated to reflect changes in development conditions, implementation of regional detention facilities and other factors. In these cases, a first step in

hydrologic modeling is to compare results from the previous models being used to the hydrology from the study that is being updated. This is a critical step that is necessary due to changes in algorithms in CUHP and SWMM over time, as models have evolved. It is also a useful step for detecting and correcting input errors from earlier models where numeric input file formats made it more difficult to find input problems than current graphical user interfaces and GIS-based methods.<sup>1</sup> When there are differences in baseline hydrology results simply due to changes in model algorithms, the baseline hydrology is “calibrated” back to original model conditions.<sup>2</sup> Once the baseline hydrology model has been corrected and “calibrated” to the previous study, model inputs are adjusted based on current and future-projected changes in physical conditions such as revised imperviousness, regional detention, channel modifications, etc.

### 3.3.2 Alternatives Analysis

After completion of baseline hydrology, the alternatives analysis process is initiated based on stream reaches, sub-catchments, or other planning zones. These planning areas are typically defined based on geopolitical boundaries, changes in stream characteristics, roadway crossings and other major land features. The goal of the alternative development process is to identify problem areas within each planning reach and develop a range of alternatives that mitigate the problem. For purposes of evaluating improvements, UDFCD design criteria and guidance for improvements such as open channels, culverts, storm drains, grade control structures, stabilization measures, and detention basins (as well as the hydrologic methodologies used to size the facilities) are followed. Alternatives are then evaluated based on considerations such as right-of-way acquisition, cost, constructability, long-term maintenance issues, environmental impacts (and benefits), multiuse functionality, and public acceptance.

Although each watershed is unique and there is no standard formula that can be used for each planning study, alternatives considered typically include options such as these:

- “Status Quo” – the “do nothing” alternative that maintains the existing configuration. This alternative provides a baseline for comparison of other alternatives. There are costs associated with a “do nothing” alternative related to ongoing flooding issues, existing and future channel stability, maintenance and other factors.
- Floodplain preservation.
- Conveyance improvements including new channels and restoration/improvement of existing channels.
- Road crossings, including culverts and bridges.
- Channel stabilization – grade control structures to prevent vertical degradation and bank stabilization measures to prevent lateral migration.

---

<sup>1</sup> This process is analogous to the Duplicate Effective and Corrected Effective modeling process that is used for FEMA floodplain modeling with HEC-RAS.

<sup>2</sup> This calibration exercise involves engineering judgment and familiarity with sensitivity of CUHP and SWMM to input parameters. The goal of the calibration is to obtain reasonable agreement between the previous and current studies in the context of overall hydrologic model uncertainty. Drainage engineers should exercise caution when adjusting inputs for calibration to be sure that parameters are physically realistic and within published ranges.

- Detention and/or water quality planned at the regional level. Detention and water quality are frequently planned conjunctively.
- Acquisition of flood-prone properties and other non-structural measures (e.g., easements).

Alternatives are evaluated based on many factors, including:

- The balance of detention and conveyance needed for flood mitigation.
- How the alternative fits into the existing area based on right-of-way acquisition and easements, transportation, general consistency in long-term floodplain and stormwater management along the corridor.
- Environmental considerations.
- Property rights considerations (e.g., detention is generally not proposed on private lands due to difficulty in future implementation without invoking the power of eminent domain).
- Benefit-cost analysis.
- Regulatory/permitting constraints.
- Public safety.
- Aesthetics.
- Public acceptance.
- Operation and maintenance requirements.
- Other feasibility issues.

Estimation of costs to implement improvements is a key component of the alternatives analysis. Costs for each alternative are developed based on approximate unit costs for each improvement. To assist with development of cost estimates, the UD-MP Cost workbook available at [www.udfcd.org](http://www.udfcd.org) can be utilized. Typical costs considered include capital costs, land costs (e.g., ROW, permanent or temporary easement), engineering/legal/administrative costs, construction costs, maintenance costs and a contingency factor.

Regulatory constraints are also considered during the alternatives analysis phase. Implementation of drainage plans is affected by a variety of federal, state and local permit requirements. When developing drainage master plans, it is important to be aware of how these requirements can affect the feasibility of planned improvements. In particular, Section 404 permits and threatened and endangered (T&E) species issues can have significant effects on planned drainage improvements and should be considered during the planning process, not just prior to construction.

Because of the high quality wetland and riparian ecosystems associated with waterways, many species of wildlife spend part of their life cycle in these corridors. The U.S. Fish and Wildlife Service (USFWS) regulates T&E species, and if a T&E species, or habitat for a T&E species, is present in a project area, federal permitting will likely be required. Two of the most commonly encountered T&E species within the riparian areas of the Colorado Front Range are the Preble's Meadow Jumping Mouse and the Ute Ladies'-tresses Orchid.

### Section 404 Permits

Section 404 of the federal Clean Water Act regulates the discharge of dredged and fill material into waters of the United States, including wetlands. The USACE administers individual and general permit decisions, jurisdictional determinations and enforces Section 404 provisions. Prior to discharging dredged or fill material into the waters of the United States, a Section 404 permit must be obtained from the USACE. Waters of the United States include essentially all surface waters such as all navigable waters and their tributaries, all interstate waters and their tributaries, all wetlands adjacent to these waters, and all impoundments of these waters. Typical activities requiring Section 404 permits include:

1. Site-development fill for residential, commercial, or recreational construction.
2. Construction of revetments, groins, breakwaters, levees, dams, dikes, and weirs.
3. Placement of riprap.
4. Construction of roads.
5. Construction of dams.
6. Any grading work affecting Waters of the United States.

Any person, firm, or agency (including federal, state, and local government agencies) planning to work, dump, or place dredged or fill material in waters of the United States, must first obtain a permit from the USACE. Other permits, licenses, or authorizations may also be required by other federal, state, and local agencies, and the issuance of a 404 permit does not relieve the proponent from obtaining such permits, approvals, licenses, etc.

Other water quality permit-related requirements also apply with regard to erosion and sediment control practices during construction, as discussed further in Volume 3 of this manual.

### 3.3.3 Conceptual Design

Based on the Selected Plan that emerges from the alternatives analysis, the conceptual design is intended to provide guidance to the project sponsors for future planning and capital improvement projects along streams within the study area. The conceptual design typically provides reach-by-reach recommendations for improvements in terms of the problems being addressed, specific recommended actions, and expected costs (capital and long-term operation and maintenance). The conceptual design Plan includes plan and profile drawings for each reach, as well as details for typical channel sections, ditch crossings, drop structures, detention ponds, and other features. The conceptual design serves as the “roadmap” for future improvements to streams.

Major components of the conceptual design include:

- **Plan Development Overview:** Describes how the master plan will prevent or mitigate drainage problems and damages and documents the rationale for changes from the Selected Alternative (if any).
- **Master Plan Description:** Describes the Master Plan on a reach-by-reach basis, along with costs, mapping and profiles.



- **Prioritization and Phasing:** Discusses priority of improvements, specifically how they are interrelated to other improvements, which are independent, which need to be implemented first and which need to be implemented as a system to avoid transferring damage potential to other reaches. MS4 requirements should also be considered with phasing improvements.
- **Water Quality Impacts:** Describes how the plan addresses stormwater quality or mitigates stormwater quality impacts on the receiving system.
- **Operations and Maintenance:** Describes operations and maintenance aspects and costs of master plan.
- **Environmental and Safety Assessment:** Describes how the recommended alternative will affect the environmental character and public safety of each reach and how it will fit into the community being served.

### 3.4 Alternative Plan Components

Drainage plans typically address conveyance, channel stabilization, acquisition of flood-prone property or structures, stream crossings, detention (storage), and water quality. Each of these components is discussed further below. Although these components are discussed separately below, they are interrelated. For example, there are often tradeoffs between detention and conveyance (increasing detention storage can reduce conveyance needs and vice versa).

#### 3.4.1 Conveyance

Conveyance alternatives consider channel improvements needed to convey large flood events (typically the 100-year flood, although lesser events may be considered to improve undersized systems). Conveyance-based alternatives can be cost effective and provide benefits to the community, especially when there is space available for integration with trails and open space. Depending on how the conveyance improvements are implemented, there can be potential for a loss or significant alteration of natural ecological resources, especially in areas with greater space constraints. As a result, the aesthetic and environmental concerns of conveyance alternatives must be carefully evaluated.

Conveyance objectives can often be achieved by using stabilized, naturalized channels with improvements such as bridges or culverts at road crossings. In areas of existing development with flooding problems and undersized drainage systems, lined, engineered channels and/or closed systems that maximize conveyance within a limited right-of-way may be needed.



**Photograph 3-4.** An engineered wetland channel can serve as a filter for low flows and carry the major flood event without damage. Wetlands and vegetated overbank areas aid in providing transient storage that is beneficial for attenuating runoff.

For the major drainage system, using open channels rather than closed conduits has significant advantages in regard to costs, capacity, multi-use potential, aesthetic purposes, environmental protection/enhancement, and potential for detention storage. A constraint for open channels relative to closed conduits is the greater right-of-way requirement (e.g., the inability for a roadway to be built atop the stream) for an open channel system. Careful planning and design are needed to minimize disadvantages and maximize benefits. See the *Open Channels* chapter for design principles.

#### **Benefits of Open Conveyance**

- **Public Awareness – Visibility** serves as a reminder to the community that stormwater quality is important and that potential for flooding exists, whereas a piped system diminishes the value of stormwater and streams and also hides the function of conveyance.
- **Safety** – Open channels offer egress to escape flow when a person or animal unintentionally enters the water.
- **Excess Capacity** – The freeboard provided in an open channel will provide protection for a storm event higher than the design storm.
- **Overbank Storage** – Overbanks offer significant inadvertent detention that provides an extra level of protection that is not available when flows are conveyed underground.
- **Water Quality** – The natural bottom of a channel provides contact between the water and both soil and vegetation. This provides water quality benefit not available in a piped system.
- **Habitat** – Open channels provide opportunities for riparian vegetation and wildlife habitat.
- **Education** – A naturalized open channel can provide an outdoor classroom experience in an urban setting, bringing the public closer to nature.

### **3.4.2 Stabilization**

Channel stabilization is typically needed in developing areas to mitigate the erosive impacts of urbanization. Grade control structures prevent downward incision of streams. When strategically positioned to reduce the longitudinal slope of channels, they help stabilize streams, thus protecting existing riparian zones, private and public property and urban infrastructure (DeGroot and Urbonas, 2000). The protection and/or establishment of wetland and riparian vegetation upstream of these structures is an added habitat benefit. Grade control structures also reduce silt deposits in downstream aquatic-habitat areas (Urbonas and Doerfer 2003).

Two categories of grade-control structures are typically considered in MDPs: drop structures and check structures. Drop structures are mitigation measures to raise the degraded bottom of a stream to return its elevation close to what was there before degradation occurred. Check structures are preventive and are installed as hard-points across the stream before degradation occurs. Planning for such structures is an

important element in any master-planning project for urbanizing watersheds (Urbonas and Doerfer 2003).

Increasingly, other forms of channel restoration involving bioengineering methods, which go beyond traditional stabilization practices, are also being considered. See the *Open Channels* chapter for additional discussion of stream restoration techniques.

### 3.4.3 Acquisition of Flood-prone Properties or Structures

Acquisition of flood-prone properties and structures can be a very effective way to preserve floodplains and reduce flood hazards. Many municipalities have parks and open space programs that have acquired and continue to acquire land for this purpose, including large tracts of floodplains. When landowners develop along drainage corridors, the area within the floodplain is often dedicated to the municipality as an open space or park tract. The open space provides multiple benefits to the community including trails, recreation, wildlife and, most importantly, keeps development out of a hazardous location. Floodplain acquisition is also a major factor to consider in planning locations of detention and water quality facilities within or adjacent to the floodplain.

Acquisition is also an alternative considered in areas with frequent flooding due to undersized drainage systems, often in older neighborhoods developed before modern floodplain regulations. Although it is typically far more expensive to acquire developed lots in urban areas than undeveloped floodplain land, acquisition of flood-prone properties and structures may be necessary to upgrade undersized systems and reduce flood hazards in developed areas that have undersized drainage systems. Often the cost of infrastructure required to remove the flood hazard from one of these properties far outweighs the cost of acquiring the property when it is put up for sale.

### 3.4.4 Crossing Structures

Crossing structures often include transportation features that cross or run parallel to major channels and streams, along with major utilities and pedestrian bridges. Many existing flood problems are due to inadequate waterway openings (bottlenecks) under transportation facilities. These inadequate openings have resulted from lack of appropriate basic criteria or changes in criteria, lack of good planning, lack of proper hydraulic engineering, and lack of coordination between the various agencies. Many storm drainage problems can be avoided by cooperation and coordination between the various public agencies and public and private stakeholders in the very early stages of planning for storm drainage infrastructure associated with transportation features. This coordination is essential to providing proper drainage at a reasonable cost.

Transportation agencies often focus on drainage improvements needed for their specific projects; however, such planning should be integrated with drainage planning for the adjacent urban area. For example, in some cases, transportation-related drainage facilities may also need to be designed to intercept and convey storm runoff from a significant urban watershed. In design and construction of sound barriers along freeways, which can act as dams impeding conveyance, highway designers must account for the major drainage needs of the uphill land and provide a way for the water to pass under or around the sound barriers without backing up. A similar situation develops with the construction of crossings – roadway embankments or median barriers that impede flow. These can create costs that should be avoided. In such cases, cooperation between the transportation agency and the local government is particularly advantageous so that joint planning, design, and construction can result in a better urban environment.

See the *Culverts and Bridges* and the *Stream Access and Recreational Channels* chapters of this manual for specific guidance related to channel crossings that should be considered during the master planning process.

### 3.4.5 Detention (Storage)

Detention and retention storage for flood control are key components of drainage planning, as described in the *Policy* and *Storage* chapters of this manual. Although on-site, subregional and regional flood detention facilities all play a role in drainage and floodplain planning, only detention and retention facilities with assurances for construction and perpetual operation and maintenance are considered in master plans. For planning purposes, UDFCD adheres to the following policies when developing hydrology for the delineation and regulation of the 100-year flood hazard zones:

1. Hydrology must be based on fully developed watershed condition as estimated to occur, at a minimum, over the next 50 years.
2. No detention basin will be recognized in the development of hydrology unless:
  - a) It serves a watershed that is larger than 130-acres or otherwise significantly reduces the downstream flow rate, and
  - b) It provides a regional function, and
  - c) It is owned and maintained by a public agency, and
  - d) The public agency has committed itself to maintain the detention facility so that it continues to operate in perpetuity as designed and built.



**Photograph 3-5.** Urban stormwater detention basins can create neighborhood amenities that at the same time serve their flood control function.

### Importance of Implementing Master Plan Recommendations

The success of any master plan depends upon whether or not it is implemented. The master plan provides a “roadmap” for the future and provides the basis for incorporating the facilities and practices it recommends as lands develop or when funds become available to design and build new facilities. It also provides coherence of function so that each stormwater management facility, whether a channel, culvert, storm sewer, or detention basin provides the needed function to make the entire system work. Site drainage cannot function in a vacuum; it is affected by what happens upstream and, in return, affects what happens downstream.

When implementing a master plan a certain amount of flexibility is warranted, however, the spirit of the plan and its major features must not be compromised if the community desires to have the system function as intended in the plan. Nevertheless, some modifications of the plan are expected over time. Any major omission of a critical plan element, such as a regional flood-detention basin, will render the plan ineffectual and create a potential for damage to public health, safety, and welfare.

Any master plan is a living document. It cannot remain static for too long without outliving its usefulness. Thus, as areas urbanize and facilities are installed, it becomes evident over time that the assumptions made when the plan was developed may have changed, or the community needs are not the same anymore. As a result, most master plans have to be updated over time.

(Urbonas and Doerfer, 2003)

Storage areas for detention and water quality can have significant multipurpose uses and benefits related to recreation, water quality, aesthetics, and wildlife. In order to maximize these benefits, early coordination among the engineer, planner, parks and open space staff, and others is needed.

As a part of local ordinances across the UDFCD region, flood detention is required for new development and redevelopment. In some areas, regional facilities provide detention while in others sub-regional and on-site facilities are common. Under certain circumstances flood detention facilities may not be needed, although volumetric water quality may still be required. This is typically only the case for onsite facilities that have all of the following characteristics:

- The area has a direct outfall to a major waterway and is a small fraction of the overall watershed area with a time of concentration that is much shorter than the watershed time of concentration. Theoretically, for a uniformly spatially-distributed design storm, the runoff peak from a small, undetained property under this condition would enter the major drainage system and flow downstream long before the peak from the overall watershed occurs. This theory is often referred to as “beat the peak.”
- There are no benefits to be realized from detention in terms of sizing conveyance infrastructure from the property to the point of outfall.
- Undetained flows will not cause adverse impacts in terms of flooding, erosion and water quality to other structures or property, on the property or between the property and the point of outfall.

The decision on whether to grant a waiver from detention requirements typically rests with the local floodplain administrator.

### 3.4.6 Water Quality

Drainage planning for quantity (rate and volume) should proceed hand-in-hand with planning for water quality management. Generally, in urban areas, water quantity and water quality are inseparable. Volume 3 of the USDCM provides design criteria for best management practices (BMPs) recommended to mitigate the adverse effects of increased runoff rates and volumes and pollution, both during and post-construction. Another essential aspect of water quality protection is stream stability. Unstable streams can experience significant degradation and aggradation, both of which can be detrimental to aquatic life. Consequently, channel stability must be addressed during the planning process.



**Photograph 3-6.** A wide, open waterway carries floodwater at modest depths while maintaining low velocities to inhibit erosion.

## 4.0 Floodplain Management

Urbanization modifies the natural hydrologic and water quality response of the watershed. Because urbanization usually proceeds in accordance with land use rules and land development regulations and with the review and approval of detailed development plans, the local government in effect becomes a party to the inevitable hydrologic modifications. It follows that a community cannot disclaim liability from the consequences of such development, either upon the developed area itself or downstream therefrom. Government has a responsibility to protect the public’s health and safety;



therefore, it is implicit that government is at the risk of incurring liability if it permits unwise occupancy or use of the natural floodplain easement. Floodplain regulation is the government's response to limit its liability and is an exercise of its health and safety protective function. The concept of the existence of a natural easement for the storage and passage of floodwaters is fundamental to the assumption of regulatory powers in a definable flood zone. Floodplain regulation must define the natural easement's boundaries and must delineate easement occupancy consistent with total public interests.

Key components of floodplain planning include reduction of the exposure to floods, use of development policies, disaster preparedness, flood risk management (see the *Flood Risk Management* chapter). The administrative tools created to undertake and implement a floodplain management program require a commitment of personnel, financing, and other resources. Flood control planning should consider the following management measures:

- Appropriate measures to limit development of land that is exposed to flood damage including:
  - Enacting floodplain management or other restrictive ordinances (i.e., building, subdivision, housing and health codes).
  - Preempting development of vacant flood fringe areas by public acquisition of land where appropriate for good drainage and community planning.
  - Adhering to Colorado Water Conservation Board (CWCB) and/or Federal Emergency Management Agency (FEMA) higher regulatory standards (critical facilities, freeboard, minimum floor elevations, etc.).
- Appropriate measures to guide proposed development away from locations exposed to flood damage include:
  - Developing floodplain regulations.
  - Limiting access to flood-prone areas.
  - Requiring setbacks from channel banks.
  - Restricting the reconstruction without mitigation of properties damaged by floods.
  - Withholding public financing from development projects in the floodplain.
  - Withholding utilities (electricity, water, sewers, etc.) from flood-prone area development.
  - Examining equivalent or similar alternative sites.
  - Maintaining low property value assessment for tax purposes allowing flood-prone land to economically remain idle.
  - Providing incentives for floodplain dedication to the public such as density credits.
- Appropriate measures to assist in reducing individual losses by flooding in areas developed before flood damage exposure was identified include:

- Structural flood abatement devices.
- Flood-proofing buildings.
- Early warning systems.
- Emergency preparedness plans (e.g., sandbagging, evacuation, etc.).
- Ongoing maintenance of the minor and major drainage systems.
- Disaster relief (funds and services).
- Tax subsidies (i.e., ameliorating assessments).
- Floodplain acquisition.

Furthermore, good urban drainage planning practices and management procedures should make it possible to initiate:

- Land use planning that recognizes flood hazards and damage that values the riparian environment along streams.
- A plan for expansion of public facilities that recognizes the implications of flood hazards for sewer and water extensions, open space acquisition, and transportation.
- Implementation of measures that demonstrate an existing or proposed floodplain management program such as:
  - Building codes, zoning ordinances, subdivision regulations, floodplain regulations, and map regulations with flooding encroachment lines. These should be consistent with land use recommendations discussed earlier.
  - Participation in regional land-use planning.
  - Participation in available floodplain management services, including flood warning systems.
  - Cooperation in flood damage data collection programs.
- Use of major public programs that are available (e.g., urban renewal, public health, open space, code enforcement, highway programs and demonstration programs).

Finally, the planner and engineers should understand the underlying principles of floodplain regulation, the requirements of the National Flood Insurance Act of 1968 (as amended), and state and local floodplain regulations to effectively plan for flood risk management.

## 5.0 Multi-use Opportunities

Regional detention facilities, preserved floodplains, and naturalized streams with hydraulically connected floodplains provide a wealth of natural and beneficial functions (NBFs), as discussed in the UDFCD’s “Good Neighbor Policy.” The land along natural streams and gulches has already been chosen by nature as a storm runoff easement for intermittent occupancy. Nature will always exact some price for use of its floodplains, so use of this land for open space is a good choice.

Zoning land for floodplains and limiting the potential uses of such land provides for open space and greenbelts that enable preservation of riparian zones. Floodplain land acquisition costs should be lower because of the limited potential for development without costly improvements and permitting.

The design team should develop park and greenbelt objectives in conjunction with the master planning and floodplain zoning. Without this early coordination, opportunities for multipurpose benefits may be lost. Additionally, working across local government departments presents opportunities to leverage funding and achieve multi-use objectives associated with open space and regional trail master plans.

### Good Neighbor Policy

In 2011, the UDFCD Board adopted a “Good Neighbor Policy,” which recognized a variety of opportunities that arise from drainage planning and programs. Among these, the UDFCD Board recognized the Natural and Beneficial Functions (NBF) of floodplains; including trail corridors, parks, recreation, wildlife habitat, flood storage, and groundwater recharge, can serve as amenities to adjacent neighborhoods and entire communities. The Good Neighbor Policy states:

- The Master Planning Program will, during the preparation of storm drainage criteria, major drainage plans, outfall systems plans, and other master planning studies, identify and incorporate NBF and other opportunities.
- The Floodplain Management Program will continue to map the 1% and 0.2% floodplains in undeveloped areas in order to identify areas that are hazardous to develop, and areas of significant NBF; and to work with local governments in the management of future development in or near these hazardous areas to minimize future flood risks and maximize preservation of the NBF.
- The Design, Construction, and Maintenance (DCM) Program will, when feasible, include amenities in flood management projects that enhance neighborhoods and preserve NBF. As a result of including these amenities, the public will be drawn to the flood management projects; therefore, public safety is of paramount importance and will be included in all planning, design, construction, operation, and maintenance of these facilities.
- The DCM Program will participate with local government partners and others such as Great Outdoors Colorado and the Trust for Public Land to acquire and preserve areas of significant NBF and/or flood hazards.
- The Information Services and Flood Warning Program will continue adapting state-of-the-art information technologies to keep decision-makers, partners and other stakeholders informed concerning past, present and future flood threats; and will provide local governments, consultants, affiliates, and the general public with easy access to educational material, publications and other helpful information associated with UDFCD programs and activities.



### Utah Park: A Multi-Use Success Story

Utah Park, located at the northeast corner of Peoria Street and Jewell Avenue in Aurora, is a recreational area heavily used by the surrounding community that also serves on rare occasions as a regional flood detention facility. Utah Park provides recreational amenities including tennis courts, ball fields, trails and open space. This park is the upper-most flood detention facility on the main stem of Westerly Creek. In 2006, Utah Park storage capacity was expanded from 135 acre-feet (roughly the volume of the 50-year flood) to 160 acre-feet, the estimated volume of the 100-year flood.

During the September 2013 flood, Utah Park exceeded its 100-year capacity, with water reaching a peak depth of over 2 feet above the 100-year level during the afternoon of September 12. Floodwaters exceeded the capacity of the overflow spillway and overtopped the western bank onto Peoria Street as designed. Despite the fact that conditions significantly exceeded the design storm (100-year event), spillway overflows caused only limited damage. In the absence of this facility, widespread catastrophic damage would have occurred from flooding.



Aerial view of Utah Park a few days after record rainfall in 2013. (Photo: David Mallory).



Utah Park providing critical flood detention during the September 2013 flood.

## 6.0 References

DeGroot, W.R., and Urbonas, B.R. 2000. Added benefits of grade control structures. *J. Floodplain Mgt.*, Floodplain Management Association, 2(1), 7-12.

Jones, D.E. 1967. Urban Hydrology—A Redirection. *Civil Engineering* 37(8):58-62.

*National Flood Insurance Act*. 1968. *U.S. Code*. Vol. 42, Secs. 4001-4129.

Urbonas, B. and Doerfer, J. 2003. Stream Protection in Urban Watersheds through Master Planning. Accessible at: <http://www.udfcd.org>.

Urban Drainage and Flood Control District. 2011. Good Neighbor Policy. Accessible at: <http://www.udfcd.org>.

Urban Drainage and Flood Control District and Wright Water Engineers. 2014. *A September to Remember: The 2013 Colorado Flood Within The Urban Drainage and Flood Control District*.



# Chapter 4

## Flood Risk Management

### Contents

<b>1.0</b>	<b>Introduction.....</b>	<b>1</b>
<b>2.0</b>	<b>Floodplain Management Fundamentals.....</b>	<b>2</b>
2.1	Basic Definitions.....	2
2.1.1	Floodplain.....	2
2.1.2	100-year Flood/Base Flood.....	3
2.1.3	Base Flood Elevation.....	4
2.1.4	Special Flood Hazard Area and Floodplain Zones.....	4
2.1.5	Floodway and Flood Fringe.....	6
2.1.6	Community Rating System (CRS).....	6
2.1.7	CRS Credits.....	7
2.1.8	CRS Application Process.....	7
2.1.9	Flood Insurance Study (FIS).....	7
2.2	Floodplain Management Strategies.....	7
<b>3.0</b>	<b>Floodplain Mapping Changes and Administration.....</b>	<b>9</b>
3.1	Background Information.....	9
3.2	Types of Regulatory Floodplain Map Changes.....	11
3.3	Requests for Letter of Map Change.....	12
<b>4.0</b>	<b>Flood Insurance.....</b>	<b>13</b>
4.1	Purchasing Flood Insurance.....	13
<b>5.0</b>	<b>UDFCD, Local, and State Floodplain Management Programs.....</b>	<b>13</b>
5.1	UDFCD Programs.....	13
5.1.1	Master Planning Program.....	14
5.1.2	Floodplain Management Program.....	14
5.1.3	Design, Construction, and Maintenance Program.....	15
5.1.4	Information Services and Flood Warning Program.....	15
5.2	Local Floodplain Regulations.....	16
5.2.1	FEMA Programs for Participating Communities.....	16
5.3	State Floodplain Rules and Regulations.....	16
<b>6.0</b>	<b>Floodproofing.....</b>	<b>19</b>
6.1	Definition of Floodproofing.....	19
6.2	Scope of Floodproofing Guidance Provided.....	19
6.3	Typical Causes of Flooding.....	19
6.3.1	Inadequate Street Conveyance.....	19
6.3.2	Inadequate Storm Drain Conveyance.....	19
6.3.3	Inadequate Channel Conveyance.....	19
6.3.4	Sewage Backup.....	20
6.4	Factors That Affect Flooding Damage.....	20
6.4.1	Depth/Elevation of Flooding.....	20
6.4.2	Flow Velocity.....	23
6.4.3	Flood Frequency.....	23
6.4.4	Rates of Rise and Fall.....	24

6.4.5	Duration .....	24
6.4.6	Impact of Debris and Contaminants in Floodwaters .....	24
6.5	Classes of Floodproofing Techniques .....	25
6.6	Floodproofing Methods.....	25
6.6.1	Overview of FEMA Methods .....	25
6.6.2	Elevation .....	26
6.6.3	Wet Floodproofing.....	29
6.6.4	Dry Floodproofing .....	31
6.6.5	Relocation .....	33
6.6.6	Levees and Floodwalls.....	34
6.6.7	Demolition .....	37
6.7	Engineering Considerations for Floodproofing Methods.....	37
6.7.1	Flood Hazard Analysis.....	37
6.7.2	Site Characteristics .....	38
6.7.3	Building Characteristics.....	38
6.8	Selection of Floodproofing Method.....	38
6.8.1	Regulatory Considerations .....	38
6.8.2	Appearance .....	39
6.8.3	Accessibility.....	39
6.8.4	Requirement for Human Intervention .....	39
6.8.5	Benefit/Cost Analysis .....	39
6.8.6	Other Considerations .....	39
6.9	Cases Where Floodproofing is Not Appropriate.....	40
<b>7.0</b>	<b>Assistance for Property Owners.....</b>	<b>40</b>
7.1	Decision-Making Process for Property Owners .....	40
7.1.1	Identification of Flood Hazards .....	40
7.1.2	Structure Inspection .....	40
7.1.3	Consultation with Local Officials .....	41
7.1.4	Consultation with Design Professional .....	41
7.2	Potential Sources of Financial Assistance at Federal, State, and Local Levels.....	41
<b>8.0</b>	<b>Glossary .....</b>	<b>44</b>
<b>9.0</b>	<b>References.....</b>	<b>53</b>

## Tables

Table 4-1. FEMA Flood Zone Definitions .....	5
Table 4-2. Advantages and disadvantages of the elevation method.....	28
Table 4-3. Advantages and disadvantages of wet floodproofing.....	30
Table 4-4. Advantages and disadvantages of dry floodproofing .....	32
Table 4-5. Advantages and disadvantages of relocation.....	33
Table 4-6. Advantages and disadvantages of levees and floodwalls.....	36
Table 4-7. Requirements for contractor and design professional services .....	42

## Figures

Figure 4-1. Floodway and flood fringe.....	6
Figure 4-2. Shared strategies to “buy down” flood risk .....	9
Figure 4-3. Schematic representation of flood depth and flood elevation.....	21
Figure 4-4. Buoyant force and hydrostatic pressure diagram.....	21
Figure 4-5. Hydrostatic pressure with wet floodproofing (allowing flood waters to enter building).....	22
Figure 4-6. Effects of moving water on a structure .....	23
Figure 4-7. Example of a structure elevated on continuous foundation walls.....	26
Figure 4-8. Example of building with wet floodproofed subgrade basement.....	29
Figure 4-9. Example of a dry floodproofed structure .....	31
Figure 4-10. Example of levee and floodwall protection .....	34
Figure 4-11. Example of a low point of entry survey .....	40



## 1.0 Introduction

This chapter addresses programs and policies adopted by the Urban Drainage and Flood Control District (UDFCD) to manage flood risks and reduce potential losses from flood events. This chapter also provides guidance for specific physical measures that can be implemented to help protect individual structures from flood damage.

Flood risk management includes all of the activities that the public and private sector can employ to reduce risk to individuals, structures, and communities from flooding. It includes master planning; floodplain management; design, construction and maintenance of flood management facilities; acquisition and relocation of structures at risk; floodplain preservation (including natural and beneficial functions); flood insurance; floodproofing; public information and awareness; flood warnings and preparedness; self-help; best management practices (BMPs); and green infrastructure. UDFCD pursues all of these activities to varying degrees. The theme of flood risk management is integrated throughout the Urban Storm Drainage Criteria Manual (USDCM), from key principles and policies in the *Drainage Policy Chapter* to guidance on master planning in the *Planning Chapter*, to criteria for designs in the *Open Channel Chapter* and others. The purpose of this chapter is to provide guidance on flood risk management topics not addressed in other portions of the USDCM. This chapter should be used in conjunction with the flood risk management policies, guidance and criteria in other portions of the USDCM.

A key component of flood risk management is the National Flood Insurance Program (NFIP), which was created in 1968 when Congress passed the National Flood Insurance Act. The NFIP is administered at the federal level by the Federal Emergency Management Agency (FEMA). UDFCD works closely with FEMA through its Cooperating Technical Partners (CTP) program.

Local, state, and federal governments and private insurance companies all have important roles related to the goals and objectives of the NFIP. The role of participating communities is especially important and is given special attention in this chapter. Communities (i.e., city, county, or other local governments) are eligible for federally-backed flood insurance if they have the statutory authority to adopt and enforce floodplain regulations and participate in the NFIP, and if they adopt the NFIP's minimum requirements, which include regulating development in mapped floodplains. Only when a community carries out its floodplain ordinance responsibilities can residents and property owners obtain flood insurance. UDFCD encourages all communities to participate in the NFIP and, currently, all of the communities within the UDFCD boundary that have mapped floodplains are participants.

### UDFCD's Approach to Floodplain Management

Historically, development has encroached into floodplains, constricted floodways, impacted ecological integrity, and removed the natural character of riparian corridors. In recent years, enlightened developers have recognized the value of preserving floodplain, wetland, and riparian areas in general. This offers the opportunity to establish the character of the new development and offer amenities that are components of livable communities and healthy economies. UDFCD therefore advocates the following approach:

- Preserve floodplain and riparian systems to the greatest extent possible,
- Mitigate the effects of watershed urbanization with stream stability techniques, and
- Restore degraded and damaged stream systems.



This chapter provides a general overview of both preventive and corrective measures for mitigating flood risks. Topics addressed include:

- Floodplain management fundamentals, including definitions, key policies, and key strategies,
- Flood Hazard Area Delineation (FHAD) studies by UDFCD,
- Flood Insurance Rate Maps (FIRMs) and revision methods, such as Conditional Letters of Map Revision (CLOMRs), Letters of Map Revision (LOMRs), and others,
- The relationship between FHADs and FIRMs,
- Flood insurance,
- Floodplain regulations, and
- Floodproofing guidance.

A glossary of flood risk management terms is provided at the end of the chapter.

## 2.0 Floodplain Management Fundamentals

### 2.1 Basic Definitions

In order to understand floodplain management, some of the key terms defined by and used throughout the NFIP are provided below. Additional terms are defined in a glossary at the end of this chapter. Much of the information provided here can also be found on the websites for FEMA (<http://www.fema.gov>) and the United States Army Corps of Engineers' (USACE) National Flood Risk Management Program (<http://www.nfrmp.us/>).

#### 2.1.1 Floodplain

A floodplain is any land area susceptible to being inundated by flood waters from any sources. Most floods fall into one of three

### Ribbons of Green

Stream corridors and adjacent riparian zones are not geographically large; however, their environmental importance is immense. "Riparian areas comprise less than one percent of the land area in most western states, yet up to 80 percent of all wildlife species in this region of the country are dependent upon riparian areas for at least part of their life cycles." (Congressional Testimony of Robert Wayland, EPA, June 26, 1997). Riparian areas are often called "ribbons of green", reflecting the contrast with the otherwise dry landscape of the arid west. Agricultural and land development activities have resulted in loss or significant degradation of 75 to 95 percent of this invaluable habitat. Development projects have the opportunity to preserve, protect, and utilize stream corridors and adjacent riparian areas. In fact, increased urban runoff often results in sustained base flows in streams that were ephemeral in the pre-development condition.

### Natural and Beneficial Functions of Floodplains

The low banks adjacent to streams are infrequently occupied by floodwaters. During a flood event, these overbank areas serve an important function in moderating peak discharges and velocities, and filtering out sediment and debris. The natural and beneficial functions of floodplains can be summarized as follows:

Flow conveyance - Floodplains have the capacity to store and convey floodwaters, thus diminishing floodwater velocities and reducing flood damages and erosion.

Soil fertility - Soil fertility is increased as periodic floodplain inundation replenishes nutrients in the surrounding soils.

Biodiversity - Floodplains enhance biodiversity, providing breeding and feeding grounds for fish and a wide variety of wildlife including endangered species.

Water quality - Floodplains improve water quality and quantity by providing areas of groundwater recharge, while also filtering impurities and nutrients.

categories: 1) riverine flooding, 2) shallow flooding, and 3) coastal flooding (not relevant within UDFCD). Riverine flooding is the most common along the Front Range of Colorado, and includes flash floods, which can occur in urban areas where impervious surfaces, gutters and storm sewers generate and convey runoff at a rate that exceeds the capacity of the receiving stream. Floodplain boundaries (i.e., the area inundated during a flood) typically are determined based on the peak runoff rate generated during a specific, design-storm event (see below).

### 2.1.2 100-year Flood/Base Flood

The 100-year flood has a 1 percent chance of occurring in any given year (Annual Exceedance Probability [AEP] = 0.01) and is referred to as the base flood by FEMA. The base flood is used by the NFIP for the purpose of requiring the purchase of flood insurance and regulating development. It should also be noted that the 100-year floodplain is an estimation of flood limits produced from a model that includes a large number of variables. At the same time, there are also variables that are not typically considered in this determination such as debris and mud flow, changes in vegetation, potential embankment failures (where present), and other “what if” scenarios. Determining the limits of flooding during this event draws a line which can be regulated. Those within “the line” and who don’t own their home are required to buy flood insurance. Those who do own their home or who may be just beyond “the line” are not required to buy flood insurance. In reality, limits of flooding associated with this event frequently include homes beyond the mapped floodplain which means that structures close to a stream, even those outside the mapped area of flooding are still at risk. UDFCD recommends providing 18 inches or more of freeboard for new development projects to account for debris flow, aggradation, and changes in vegetation, as these cannot be considered when determining the regulatory floodplain.



**Photograph 4-1.** Colorado flooding in September of 2013 forced hundreds, many of them outside of mapped floodplains, out of their homes.

#### **Properties Outside of the Mapped Floodplain are still at Risk**

“More than 17 percent of homes destroyed or damaged in four of the counties hardest-hit by the September Floods in Colorado—Weld, Larimer, Boulder, and Logan, were NOT in the floodplain” (Brown and Crummy). Flood insurance outside of the floodplain can be purchased at a relatively low cost.

### **2.1.3 Base Flood Elevation**

The base flood is used by the NFIP as the basis for mapping, insurance rating, and regulating new construction. The base flood elevation (BFE) is the computed elevation of the water surface during the base flood. BFEs are published in Flood Insurance Studies (FISs) and on FIRMs for Special Flood Hazard Areas (SFHAs) that have been identified as high-risk flooding zones and have consequently been studied in detail. BFEs are used by governmental agencies, insurance agencies, engineers, and others to manage development and determine property owners' risk to flooding.

### **2.1.4 Special Flood Hazard Area and Floodplain Zones**

The base floodplain (1 percent chance of flood) is referred to as the SFHA on NFIP maps, otherwise known as FIRMs. The SFHA can have any of several designations (e.g., Zone A, AE, A1-30, AO, AH, V, VE or V1-30), depending on the flood data available, the severity of the flood hazard, and/or the age of the flood map (see Table 4-1 for definitions of different flood zones). In addition to the SFHA, Shaded Zone X areas also exist, which are generally areas that are outside of the 100-year floodplain, areas inundated with less than one foot of water during the 100-year flood, or areas that are within the 500-year floodplain. Unshaded Zone X areas are typically areas outside of the 500-year floodplain. The SFHA is the area, at a minimum, where NFIP floodplain regulations must be enforced by a community if it is a participant in the NFIP. The SFHA is also the area where mandatory flood insurance purchase requirements apply. Detailed definitions for flood zones can also be found on FEMA's website.

**Table 4-1. FEMA Flood Zone Definitions**

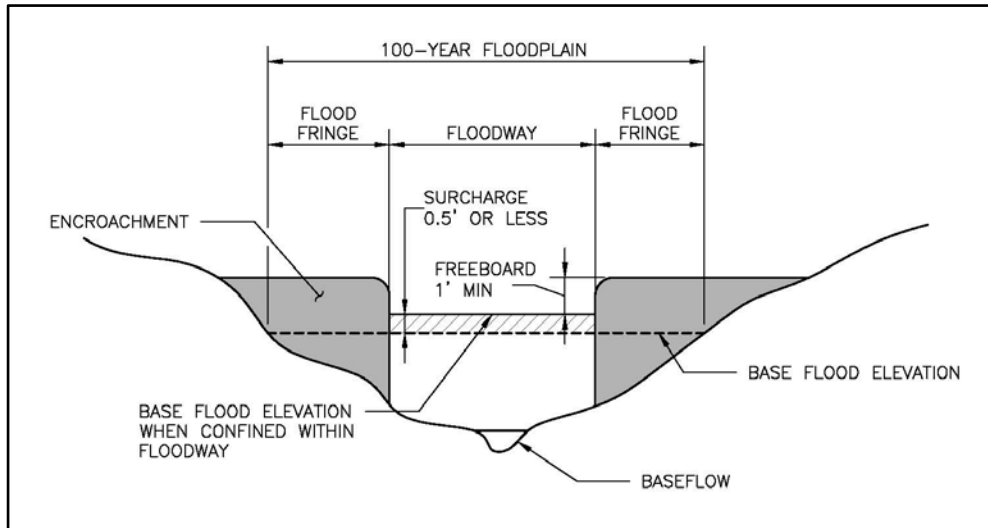
<b>MODERATE TO LOW RISK AREAS</b>	
<b>Zone</b>	<b>Description</b>
<b>B and X (shaded)</b>	Area of moderate flood hazard, usually the area between the limits of the 100-year and 500-year floods. Are also used to designate base floodplains of lesser hazards, such as areas protected by levees from 100-year flood, or shallow flooding areas with average depths of less than 1 foot or drainage areas less than 1 square mile.
<b>C and X (unshaded)</b>	Area of minimal flood hazard, usually depicted on FIRMs as above the 500-year flood level.
<b>HIGH RISK AREAS</b>	
<b>Zone</b>	<b>Description</b>
<b>A</b>	Areas with a 1% annual chance of flooding and a 26% chance of flooding over the life of a 30-year mortgage. Because detailed analyses are not performed for such areas, no depths or base flood elevations are shown within these zones.
<b>AE</b>	The base floodplain where base flood elevations are provided. AE Zones are now used on new format FIRMs instead of A1-A30 Zones.
<b>A1-30</b>	These are known as numbered A Zones (e.g., A7 or A14). This is the base floodplain where the FIRM shows a BFE (old format).
<b>AH</b>	Areas with a 1% annual chance of shallow flooding, usually in the form of a pond, with an average depth ranging from 1 to 3 feet. These areas have a 26% chance of flooding over the life of a 30-year mortgage. Base flood elevations derived from detailed analyses are shown at selected intervals within these zones.
<b>AO</b>	River or stream flood hazard areas, and areas with a 1% or greater chance of shallow flooding each year, usually in the form of sheet flow, with an average depth ranging from 1 to 3 feet. These areas have a 26% chance of flooding over the life of a 30-year mortgage. Average flood depths derived from detailed analyses are shown within these zones.
<b>AR</b>	Areas with a temporarily increased flood risk due to the building or restoration of a flood control system (such as a levee or a dam). Mandatory flood insurance purchase requirements will apply, but rates will not exceed the rates for unnumbered A zones if the structure is built or restored in compliance with Zone AR floodplain management regulations.
<b>A99</b>	Areas with a 1% annual chance of flooding that will be protected by a federal flood control system where construction has reached specified legal requirements. No depths or base flood elevations are shown within these zones.
<b>UNDETERMINED RISK AREAS</b>	
<b>Zone</b>	<b>Description</b>
<b>D</b>	Areas with possible but undetermined flood hazards. No flood hazard analysis has been conducted. Flood insurance rates are commensurate with the uncertainty of the flood risk.

**Notes:** Definitions for high risk coastal zones are not provided here because they are not relevant to areas within the UDFCD boundary.

Flood Insurance Rate Maps relevant to areas within the UDFCD boundary have all been updated with the new flood zone nomenclature, so Zones A1-30 no longer exist on these FIRMs.

### 2.1.5 Floodway and Flood Fringe

Where a detailed study has been conducted, the floodplain includes two main components: 1) the regulatory floodway and 2) the flood fringe. In most waterways, the floodway is where the water flow is deepest and most rapid; within Colorado, it is the area that must be reserved (kept free of obstructions) in order to discharge the base flood without increasing 100-year water surface elevations more than 0.5-foot. In addition to the 0.5-foot surcharge, provide a minimum of one foot of freeboard above 100-year water surface elevations as shown on Figure 4-1.



**Figure 4-1. Floodway and flood fringe**

Floodway boundaries are determined through the use of computer modeling. The flood fringe is the area located outside of the designated floodway but within the floodplain boundary. In contrast to the floodway, where no development is allowed, minimum NFIP regulations allow development within the flood fringe, though some communities adopt stricter regulations and restrict development within the flood fringe. The local floodplain administrator within a particular community can provide details about specific regulations pertaining to whether any development is allowed within the 100-year flood fringe.

### 2.1.6 Community Rating System (CRS)

The CRS program provides reductions in flood insurance premium rates based on a community's floodplain management activities. Communities that implement activities above and beyond the minimum requirements of the NFIP are eligible to receive reductions of up to 45 percent for flood insurance premiums. The reduction in rates is a reflection of reduced flood risks within the community. The voluntary program helps to reduce flood risks to insurable properties, strengthens insurance aspects of the NFIP, and encourages a comprehensive approach to floodplain management. UDFCD encourages communities to participate in the CRS program, and by doing so, citizens have an opportunity to benefit from the perspectives of both reduced flood risk and economics. Credits are provided for a variety of community flood protection activities.

### 2.1.7 CRS Credits

As a community accrues more points for implementing floodplain management activities, its CRS Class rating improves, corresponding to increasingly higher insurance discounts for its citizens. Points are awarded for engaging in any of 18 creditable activities, which fall under one of the following categories: 1) Public information; 2) Mapping and regulations; 3) Flood damage reduction; and, 4) Flood preparation.

In addition to lower flood insurance rates, there are several benefits of the CRS program:

- Increased opportunities for citizens and owners to learn about flood risk relative to their properties and businesses and how to better protect themselves,
- Enhanced public safety,
- Reduced damage to property,
- Decreased economic loss,
- Technical floodplain management activities are made available to community officials at no charge in some cases, and
- Incentives to maintain flood programs.

### 2.1.8 CRS Application Process

For a community to apply for CRS participation, their first step is to inform FEMA of their interest in applying. A CRS application must then be submitted, with documentation showing the activities the community is seeking credit for. The application, along with the floodplain activities for which the community is seeking credit, will be reviewed and verified. Once verified, the community, the State, insurance companies, and others will be notified by FEMA of the new credit to be granted.

To learn more about the CRS program, visit <http://www.fema.gov/nfip/crs.shtm> or contact UDFCD.

### 2.1.9 Flood Insurance Study (FIS)

The FIS is a report published by FEMA by county and issued along with the county FIRM. A FIS is a compilation and presentation of flood risk data for specific watercourses, lakes and coastal flood hazard areas within a community. The FIS contains background information such as the base flood discharges and water surface elevations used to develop the FIRM. The FIS and FIRM together serve as the basis for flood insurance ratings and regulating floodplain development.

## 2.2 Floodplain Management Strategies

In 1972 UDFCD adopted a two-pronged approach consisting of a comprehensive floodplain management program to prevent new problems from being created by new development, while “fixing” existing problems. UDFCD dedicates many resources to the planning, design, construction, and maintenance of projects aimed to fix past mistakes of development and works with FEMA, the Colorado Water Conservation Board (CWCB), and local governments to utilize and enforce floodplain regulations effectively. The two-pronged approach can be described as follows:

- **Floodplain Preservation.** Identify areas of significant natural and beneficial functions relevant to floodplains and manage future development in these areas in a way that preserves these floodplains. Natural and beneficial functions of floodplains include the following:
  1. Floodplains diminish floodwater velocities and reduce flood damages and erosion through their natural characteristics of conveyance and storage.

2. Soil fertility is increased as floodplains naturally replenish nutrients during times of flood inundation.
  3. Floodplains improve water quality and quantity by filtering impurities and recharging groundwater.
  4. Floodplains provide breeding and feeding grounds for fish and wildlife.
- **Mitigation of Effects of Urbanization.** Work with local governments and developers to manage future development in or near hazardous areas to minimize future flood risks and identify areas potentially subject to flood hazards by mapping the 1% (100-year) floodplain and 0.2% (500-year) floodplain in undeveloped areas. UDFCD encourages the implementation of stream stability and improvement techniques to mitigate the effects of urbanization, such as increases in flood flows, velocities, shear forces and other hydraulic parameters, which can cause erosion and stream decay.

FEMA also identifies key floodplain management strategies for reducing economic losses and reducing losses of beneficial floodplain resources as a result of flooding. Figure 4-2 illustrates how these strategies are applied to reduce flood risk through federal, state, local, and individual efforts. FEMA's four strategies are:

- **Strategy 1. Modify human susceptibility to flood damage:** Replace disruption by avoiding hazardous, uneconomic or unwise use of floodplains. This strategy includes policies such as using zoning codes to direct development out of the floodplain; acquiring land in floodplains to preserve open space; and restoring and preserving the natural resources and functions of floodplains.
- **Strategy 2. Modify the impact of flooding:** Assist individuals and communities to prepare for, respond to, and recover from a flood. Actions to implement this strategy include providing information and education to assist communities with flood protection following flood emergency measures during a flood; reducing financial impacts through disaster assistance, flood insurance, and taxes; and preparing recovery plans and programs to help people rebuild.

### Advantages of Sustainable Floodplain Management for Communities

There are tremendous advantages to communities that encourage a thoughtful approach to development adjacent to natural streams:

- UDFCD assistance in meeting NFIP maintenance responsibilities.
- CRS credits for floodplain preservation.
- Linear recreation corridors.
- Community identification and sense of community that encourages volunteerism.

### Advantages of Sustainable Floodplain Management for Developers

UDFCD recognizes that development is essential to community building. Good environmental stewardship cannot exist in the absence of a good business process. When the approach to stream corridors turns from overcoming a problem to embracing a resource, the following positive outcomes emerge:

- Lower capital costs,
- Lower operation and maintenance costs,
- Open space credits,
- Multi-use opportunities, including parks and recreation,
- Increased marketing potential,
- Lot premiums adjacent to stream corridors,
- Community character and identification, and
- Neighborhood ownership of the stream corridor.



- **Strategy 3. Modify flooding itself:** Develop projects that control floodwater. Projects include dams and reservoirs that store excess runoff from developed areas upstream; creating dikes, levees, and floodwalls around developed areas; altering channels to increase flow capacity; diverting high flows around development; increasing pervious ground covers in developed areas; and developing on-site detention.
- **Strategy 4. Preserve and restore natural resources:** Renew the purpose of floodplains by reestablishing and maintaining floodplain environments in their natural state. Policies to implement this strategy include developing land use regulations such as zoning; acquiring land for open space; permanently relocating buildings; restoring floodplains, wetlands, and habitats; educating people on the importance of floodplains as natural resources and how to protect them; and providing financial initiatives for preserving and/or restoring land.

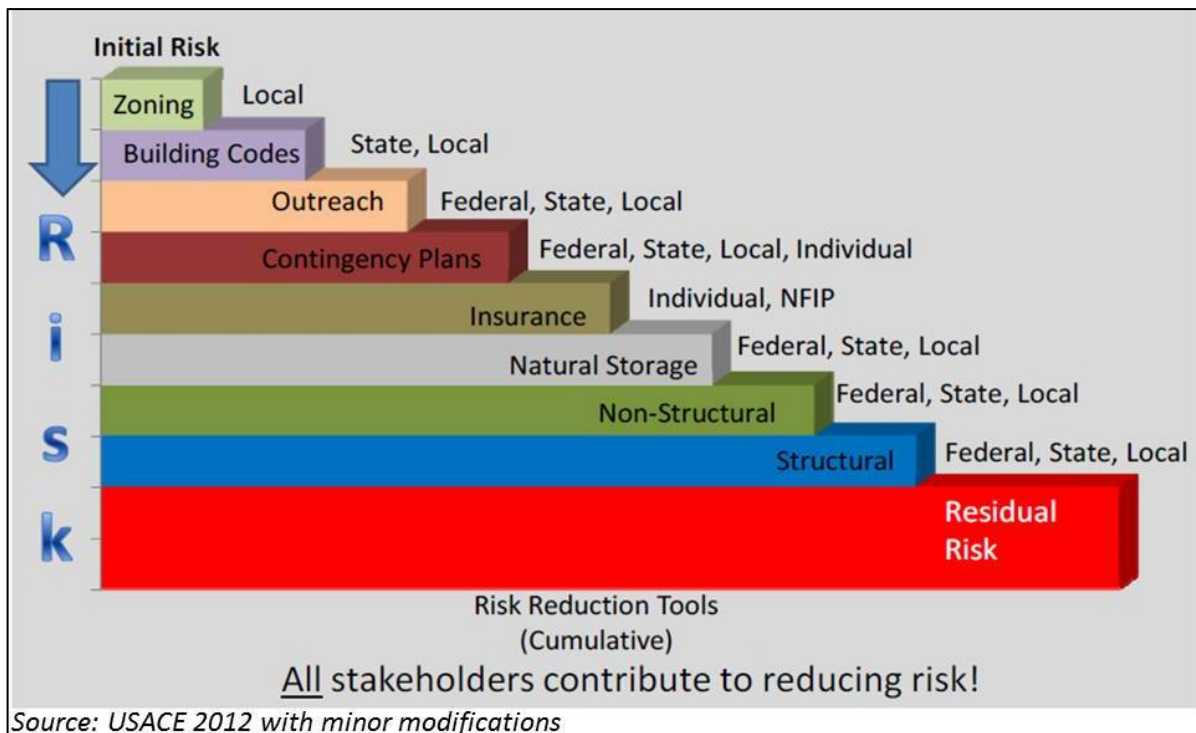


Figure 4-2. Shared strategies to “buy down” flood risk

### 3.0 Floodplain Mapping Changes and Administration

#### 3.1 Background Information

FHADs and FIRMs are important tools that allow communities to manage floodplains and help to reduce flood risk by regulating development within mapped floodplains. FHADs delineate floodplain areas inundated by the 100-year flood and publish flood profiles for the 100-year flood and other flood frequencies. Hydrologic and hydraulic studies are performed to evaluate changes in watersheds and flood hazard areas. These changes are evaluated, including Master Planning changes which have been implemented, to predict the potential extent of flooding in flood-prone areas. UDFCD offers FHADs to communities within the UDFCD boundary as a tool to help preserve floodplains and reduce the risks of flooding to existing and future development. UDFCD currently does not regulate floodplains based on



FHAD studies, but instead relies on local governments to utilize FHAD mapping in conjunction with other resources to manage and administer floodplain regulations. FHADs often serve as the basis for FEMA FIRMs.

FIRMs show information such as the locations of properties relative to the 100-year floodplain, the type of SFHA zone for a property, the relative 100-year water surface elevations (BFEs), the vertical datum used for the BFEs and more. FIRMs are also used for flood insurance ratings and for making reasonable determinations of required flood insurance. By contrast, FHADs are typically based on contour intervals of two-foot or less (i.e., more precise resolution). For this reason, FHADs should be referenced when conducting localized planning and design.

FHADs are available through the Electronic Data Management (EDM) Map available at [www.udfcd.org](http://www.udfcd.org). The EDM is a user-friendly database that provides access to many resources including FHADs, as-built drawings, design reports, major drainageway planning studies, monument information, outfall systems planning studies, and other special reports. Flood hazard information included on the EDM is based on the best available data although floodplain maps included with the actual FHAD report will provide the most detail with regard to the delineation. While information on the EDM may be more current, it may differ from the official, effective Federal flood hazard information used in the NFIP. The official Federal flood hazard information for a given location needs to be obtained from FEMA. FEMA has a National Flood Hazard Layer (NFHL) that shows all digital flood hazard information for a given location. FEMA updates the NFHL with all approved PMRs and LOMRs.

Effective FIRMs may need to be updated or corrected by FEMA, communities, UDFCD, or individuals. Reasons for revising a floodplain map include:

- Non-flood-related map features (e.g., corporate boundaries) need correction.
- Current, more accurate topography is available and needs to be incorporated.
- Existing flood data, such as base flood elevations or new hydrology, need to be incorporated.
- A flood control project needs to be reflected in the mapping.

It is important to note that many small projects, such as clearing of overgrown vegetation along channels, minor bank stabilization work, and small-scale maintenance activities and projects do not have a measurable effect on the base flood and do not warrant a map change. Requests for map changes should be prepared by an engineer familiar with the FEMA guidelines.

When new map information becomes available to a community, the community is obligated by its agreement with FEMA to submit it as soon as practicable, but not later than six months after the date that the information became available (NFIP Section 65.3). Within the UDFCD boundary, CLOMRs and LOMRs, described in Section 3.3, are currently reviewed by UDFCD, which is a CTP with FEMA.

#### **Cooperating Technical Partner**

The UDFCD Floodplain Management Program is a Cooperating Technical Partner (CTP) with FEMA and was the first CTP in the country. The Floodplain Management Program reviews Letter of Map Change (LOMC) submittals within UDFCD's service area in addition to completing flood insurance map modernization and maintenance projects.

### 3.2 Types of Regulatory Floodplain Map Changes

Four types of map changes exist related to regulatory floodplains, including:

1. Restudies,
2. Physical Map Revisions (PMRs),
3. Revisions, and
4. Amendments.

Of the four types of map changes, UDFCD typically only administers the third category, map revisions (i.e., CLOMRs and LOMRs), for communities within their boundary. Brief descriptions of the different types of map changes include the following:

**Restudy:** A restudy is a new Flood Insurance Study for a part or all of a community. A restudy may occur in cases where the hydrology (peak flow rates) has changed, perhaps due to increased development, new information, or changed topography. Another example of a restudy is when a community is interested in establishing BFEs along a watercourse located in an approximate or unnumbered Zone A (where BFEs have not previously been defined). UDFCD typically does not conduct restudies unless provided a grant to do so.

**PMR:** A PMR is an action whereby one or more map panels are physically revised and republished. A PMR is used to change flood risk zones, floodplain and/or floodway delineations, flood elevations, and/or planimetric features. A PMR requires the same detailed analysis as a LOMR but typically covers a greater area.

**Revision:** A map revision may be necessary for the following cases:

- A scientifically-based challenge to a published BFE has been confirmed.
- New flood data is available because of a flood control project.
- A physical change has occurred in the floodplain or floodway boundaries.
- New flood data are available.
- Fill has been placed in the floodplain that would change the effective floodplain.

**Amendment:** A map amendment is used to remove a specific property that was inadvertently or incorrectly mapped in the SFHA from the requirement to purchase flood insurance. For example, this can occur because of high ground that is not reflected on the map which delineates the SFHA. Map amendments do not change the SFHA on the FIRM.

#### National Flood Hazard Layer (NFHL)

The NFHL is a computer database that contains the flood hazard map information from Digital Flood Insurance Rate Map (DFIRM) databases and LOMRs. The NFHL provides DFIRM and LOMR data as one integrated dataset. Letters of Map Amendment (LOMAs) and Letters of Map Revision Based on Fill (LOMR-Fs), which are based on property descriptions, are notated with a case number but not shown graphically. An NFHL dataset includes all the digital flood hazard data that are effective and available as of the dataset release date.

NFHL coverage is available in the UDFCD region. The NFHL is available on FEMA's website and can be used with GIS, as well as Google Earth.

### 3.3 Requests for Letter of Map Change

In order to officially revise a FIRM (or DFIRM), a LOMC must be issued by FEMA. A LOMC is a letter which reflects an official revision to an effective NFIP map. There are several types of requests for LOMC that can be submitted to FEMA, two of which are submitted to and reviewed by UDFCD. These are described below:

**CLOMR:** A CLOMR is FEMA's comment on a proposed project that would affect the hydrologic and/or hydraulic characteristics of a flooding source and, consequently, result in the modification of the existing regulatory floodway or effective BFEs. A CLOMR does not revise an effective NFIP map, but rather it indicates whether the project, if built as proposed, would or would not be removed from the SFHA by FEMA if later submitted as a request for a LOMR. A CLOMR becomes effective on the date sent and there is no appeal period. UDFCD reviews CLOMR applications for all areas within its boundary.

**CLOMR-F:** A Conditional Letter of Map Revision Based on Fill (CLOMR-F) is FEMA's comment on whether a proposed project involving the placement of fill would result in an area being removed from the SFHA on the NFIP map. This letter does not revise an effective NFIP map, but indicates whether the project, if built as proposed, would or would not be removed from the SFHA by FEMA if later submitted as a request for a Letter of Map Revision Based on Fill (LOMR-F). The CLOMR-F becomes effective on the date sent. CLOMR-F applications are not reviewed by UDFCD. For a project within the UDFCD boundary, a CLOMR-F application can be sent directly to FEMA for review.

**LOMA:** A LOMA is an official amendment, by letter, to an effective NFIP map. A LOMA establishes a property's location in relation to the SFHA. LOMAs typically remove areas that are inadvertently mapped in the 100-year floodplain. While a LOMA can be used to establish that a specific structure or parcel is not included in the SFHA, LOMAs do not change the delineation of the SFHA on the FIRM. UDFCD does not review LOMA requests; such requests must be submitted directly to FEMA. The map amendment becomes effective on the date of the approval letter sent by FEMA.

**LOMR:** A LOMR is an official revision, by letter, to an effective NFIP map. A LOMR may change flood insurance risk zones, floodplain and/or floodway boundary delineations, planimetric features, and/or BFEs. The letter becomes effective after a 90-day appeal period in addition to the time required to advertise the appeal. UDFCD reviews LOMR applications for all areas within its boundary.

**LOMR-F:** A LOMR-F is an official revision, by letter, to an effective NFIP map. A LOMR-F provides FEMA's determination concerning whether a structure or parcel has been elevated on fill above the BFE and excluded from the SFHA. LOMR-F applications are not reviewed by UDFCD; they must be submitted directly to FEMA. The map amendment becomes effective on the date of the approval letter sent by FEMA. A LOMR-F does not change the SFHA on the FIRM, and is therefore discouraged by UDFCD.

If physical changes to the floodplain have changed the flood hazard information shown on the effective FIRM, a revision must be requested. As soon as practicable, but not later than six months after the date such information becomes available, a community must notify FEMA of the changes by submitting technical or scientific data in accordance with Code of Federal Regulation 44 CFR 65.3. The request must be accompanied by the appropriate portions of the MT-2 application forms package, titled *Revisions to National Flood Insurance Program Maps* (FEMA Form 81-89 Series), along with the required supporting information. Within the UDFCD boundary, UDFCD will review the request on FEMA's behalf. See FEMA's website for all map change forms.

## 4.0 Flood Insurance

The Flood Disaster Protection Act of 1973 added a key requirement to the NFIP. If a community participates in the NFIP, flood insurance is a prerequisite for receiving grants or loans for the purchase of buildings located in a designated floodplain, if the grant or loan is from a federal agency or through a federally-related loan program.

The mandatory flood insurance requirement applies to all forms of federal or federally-related financial assistance for buildings located in SFHAs. The requirement applies to secured mortgage loans from all financial institutions such as lenders, savings and loan institutions, banks, etc., as well as all mortgage loans purchased by Fannie Mae or Freddie Mac.

### Population Growth and Floodplain Management

Since 1969 the population living within the boundaries of the UDFCD has tripled; however, UDFCD estimates that there are 5,000 fewer structures in mapped 100-year floodplains than there were in 1969. This is due to UDFCD's two-pronged approach to floodplain management of preserving floodplains in areas that have not yet developed and implementing remedial measures where there are existing flood hazards.

### 4.1 Purchasing Flood Insurance

NFIP coverage is available to all owners of eligible property (a building and/or its contents) located in a community participating in the NFIP. Either property owners or renters may insure their property against flood loss. As long as a property is located in a community that participates in the NFIP, it is eligible to have flood insurance, even if the property is not located in a designated floodplain, provided that the building has two or more outside rigid walls, a fully secured roof affixed to a permanent site, and the building is not: 1) located entirely over water, or 2) located principally below ground. Owners of buildings under construction, condominium associations, and owners of residential condominium units in participating communities all may purchase flood insurance. Condominium associations may purchase insurance coverage on a residential building, including all units, and the building's commonly owned contents under the Residential Condominium Building Association Policy (RCBAP). The unit owner may separately insure personal contents as well as obtain additional building coverage under the Dwelling Form as long as the unit owner's share of the RCBAP and the added coverage do not exceed the statutory limits for a single-family dwelling. The owner of any condominium unit in a non-residential condominium building may purchase only contents coverage for that unit.

## 5.0 UDFCD, Local, and State Floodplain Management Programs

As noted in Section 1, a primary component of flood risk management is the NFIP, which is administered at the federal level by FEMA (within the UDFCD boundaries, UDFCD acts as an agent of FEMA). At the state level, floodplain rules and regulations are promulgated by the CWCB, and at the local level, the requirements of the NFIP, at a minimum, are adopted and enforced by communities that participate in the NFIP. Pertinent regulations at the different levels of government are summarized in the following sections.

### 5.1 UDFCD Programs

UDFCD operates four programs, all of which play a role in flood risk management. These programs include:

- The Master Planning Program identifies areas of existing problems, areas that will require

improvements as development occurs in the future and addresses the preparation of conceptual plans for drainage and flood control infrastructure.

- The Floodplain Management Program serves to keep new land development out of floodplains, while emphasizing their natural and beneficial functions.
- The Design, Construction and Maintenance Program corrects existing problems, emphasizing multiple-use opportunities, and maintains structural and non-structural solutions.
- The Information Services and Flood Warning Program provides valuable support to the preceding programs.

This approach to floodplain management has been effective, with the Floodplain Management Program leading preventive efforts and the Design, Construction, and Maintenance Program focusing on remedial efforts. Both of these are supported by the Master Planning and Information Services and Flood Warning Programs.

Descriptions of these programs as they pertain to floodplain management are provided below:

### 5.1.1 Master Planning Program

The Master Planning Program partners with communities within the UDFCD boundary in the development of master plans—Major Drainageway Plans and Outlet System Plans. Master plans are an important tool to help identify remedial flood risk management projects for construction and to guide new land development projects to be consistent with regional drainage and flood control needs. Master plans also provide valuable input to UDFCD’s Five Year Capital Improvement Program, and help with the identification and acquisition of rights-of-way for future capital improvements and areas for preservation. The master planning program at UDFCD also promulgates design criteria for use by consultants working on UDFCD projects and those working for a developer.

### 5.1.2 Floodplain Management Program

One of the primary functions of the Floodplain Management Program is to prevent new flood damage potential from being introduced into the 100-year floodplains. This program assists local governments to assure they remain in the NFIP and keep flood insurance available for their citizens. UDFCD also works with FEMA and, since 2001 has received annual grants from FEMA to review requests for Letters of Map Change to FIRMs at the local level. UDFCD also has received several grants from FEMA for map modernization and maintenance.

#### “Good Neighbor Policy”

The UDFCD “Good Neighbor Policy” was passed by the UDFCD Board of Directors in 2011 in recognition of the importance of natural and beneficial functions of streams and floodplains, including trail corridors, parks, recreation, wildlife habitat, flood storage and groundwater recharge. The policy states UDFCD’s commitment to preserving and enhancing natural and beneficial functions in all UDFCD programs. The policy includes partnering with local governments and others such as Great Outdoors Colorado and the Trust for Public Land to acquire and preserve areas of significant natural beneficial functions and/or flood hazards. The “Good Neighbor Policy” formalizes approaches that have been developed for many years by UDFCD to sustainably manage streams and floodplains.

In lieu of using its authority to regulate floodplains, UDFCD provides an incentive program, called the Maintenance Eligibility Program (see inset), and works with local governments to implement their own regulations.

The Floodplain Management Program reviews and comments on proposed developments in or near floodplains at the request of local governments. Through this process, developers and local governments are strongly encouraged to follow or implement the appropriate portions of UDFCD master plans. This also provides an opportunity for UDFCD to guide development away from the floodplains and to encourage communities to utilize the natural and beneficial functions of the floodplains as assets to their developments and their communities.

#### **UDFCD Maintenance Eligibility Programs**

In 1980, UDFCD adopted a Maintenance Eligibility Policy, which states: “Facilities constructed by, or approved for construction by, a local public body as of March 1, 1980, must be approved by the UDFCD in order for these facilities to be eligible for UDFCD maintenance assistance.” The Maintenance Eligibility Program is run by the Floodplain Management Program and provides a mechanism for UDFCD to ensure that facilities are built to criteria that both allow for maintenance and provide multi-use benefits and preservation of beneficial natural functions.

With a preference for preservation over channelization or fill, the determination of maintenance eligibility rests with the Floodplain Management Program. The less disruption of the floodplain, the easier it is for the project to be eligible. In many cases, grade control and a maintenance access trail are all that is required to be eligible for maintenance.

### **5.1.3 Design, Construction, and Maintenance Program**

The design and construction of master-planned projects are carried out through the Five Year Capital Improvement Plan (CIP). Each year the UDFCD Board adopts a Five Year Capital Improvement Plan which lists projects and UDFCD participation for the next five years. This plan forms the basis for UDFCD participation in design and construction projects. The emphasis of the Design, Construction and Maintenance Program is to provide flood management projects that serve multiple purposes, and to the extent possible, preserve, enhance, or recreate the natural and beneficial functions of the floodplain.

The Design, Construction, and Maintenance Program also provides long term maintenance for projects built by UDFCD, as well as those approved as part of the Maintenance Eligibility Program. This maintenance includes routine efforts such as debris removal and management of the vegetation, as well as long term structural repairs as needed for drainage facilities.

### **5.1.4 Information Services and Flood Warning Program**

The Information Services and Flood Warning Program was established to enhance flood warning capabilities within the UDFCD region and consolidate and make available pertinent information. The Flood Warning Program assists local governments in developing flood warning plans and installing and maintaining automated flood detection networks. In addition, UDFCD contracts with a meteorological service to provide local governments with early predictions of flood potential and to warn them as flood threats become more imminent. Daily forecasts and real-time data are available from UDFCD’s website. This UDFCD Program includes a number of vital multi-program support functions such as: developing, operating and maintaining UDFCD’s Geographic Information System (GIS). GIS is used extensively for DFIRM production and maintenance, tracking projects for maintenance eligibility, design and



construction projects, routine and restorative maintenance projects, flood threat recognition and warning decision support, data sharing, regional mapping initiatives, and other applications.

## 5.2 Local Floodplain Regulations

For the purposes of the NFIP, a community is a political entity that has the authority to adopt and enforce a floodplain ordinance for the area under its jurisdiction. The participating communities in the NFIP carry out floodplain administration at the local level. Communities can benefit from both FEMA programs and UDFCD programs, as described below.

### 5.2.1 FEMA Programs for Participating Communities

There are two key FEMA programs for participating communities:

**Community Rating System (CRS):** The CRS is a voluntary program established by the NFIP to assist communities that want to reduce flood insurance premium rates based on a community's floodplain management activities. Communities that implement activities above and beyond the minimum requirements of the NFIP are eligible to receive reductions in rates of up to 45 percent for flood insurance premiums for properties within the community. Credits are provided for a variety of community flood protection activities (ASFPM 2009).

**Community Assistance Program (CAP):** (FEMA 480) CAP is a FEMA program that funds state activities which help communities that participate in the NFIP. States participating in the NFIP are eligible for CAP federal funding assistance. CAP is intended to help states identify, prevent and resolve floodplain management issues in participating communities prior to a flood occurring (ASFPM 2009).

## 5.3 State Floodplain Rules and Regulations

Rules and regulations for regulatory floodplains in the State of Colorado are designated and approved by the CWCB, which is part of the Department of Natural Resources (DNR). In general, the purpose of the Colorado rules are to provide uniform standards for regulatory floodplains in Colorado and to provide standards for activities that may impact regulatory floodplains.

The Colorado rules also assist the CWCB and communities with the development of floodplain management practices that are sound and that facilitate implementation of the NFIP. The Colorado rules apply throughout the state, regardless of whether a community participates in the NFIP. The rules also apply to activities conducted by state agencies and to federal activities that are fully or partially financed

### Useful Links for Federal Floodplain Regulations

Code of Federal Regulations

44 CFR, Parts 59, 60, 65 and 70 <http://ecfr.gpoaccess.gov>

NFIP

Information and links on multiple aspects of the NFIP <http://www.fema.gov/business/nfip>

FEMA Map Service Center

Flood Insurance Rate Map information <http://www.fema.gov/national-flood-insurance-program/map-service-center>

by state funds, or for projects or studies for which the CWCB has made a loan or grant (DNR 2010).

The most recent version of the rules and regulations for Colorado was adopted on November 17, 2010 and became effective on January 1, 2011. The revised Colorado floodplain rules and regulations include 20 rules. Obtaining the complete version of these rules from CWCB website (<http://cwcb.state.co.us/legal/Pages/Rules.aspx>) is recommended. A few key aspects of these rules include the following:

**Critical Facilities:** The revised Colorado rules have special requirements for Critical Facilities regarding development in floodplains (see inset).

**Standards for Regulatory Floodways:** In cases where floodways are to be delineated through physical map revisions involving local government participation, communities shall delineate floodways for the revised reaches based on a 0.5-foot rise criterion. (Note: This is a change from the previous rules, which based floodways on a 1-foot rise criterion. For the definition of “floodway,” see the Glossary at the end of this chapter.)

**Criteria for Determining the Effects of Flood Control Structures on Regulatory Floodplains:**

If a publicly operated and maintained structure is specifically designed and operated either in whole or in part for flood control purposes, its effects shall be taken into consideration when delineating the floodplain below such structure. If a structure is not specifically designed and operated for flood control purposes (e.g., such as a roadway embankment), then its effects shall not be taken into account, even if it provides inadvertent flood routing capabilities that reduce the 100-year flood downstream. In addition, the CWCB recommends that irrigation facilities (including, but not limited to, ditches and canals) not be used as stormwater or flood conveyance facilities, unless specifically approved and designated by local governing jurisdictions and approved by the irrigation facility owners.

### Critical Facilities – Floodplain Regulation

Critical Facilities in Colorado are subject to special requirements regarding their location within regulatory floodplains. Critical Facilities generally consist of the following categories (refer to the state regulations for detailed descriptions):

**Essential Services:** These include police and fire stations, hospitals, emergency shelters, communication hubs (e.g., telephone, broadcasting, etc.), public utility plants, and air transportation lifelines (airports, helicopter pads, air traffic control centers). Wastewater treatment plants, water treatment plants and hydroelectric facilities are specifically exempt from this category.

**Hazardous Materials:** Facilities that produce or store highly volatile, flammable, explosive, toxic and/or water-reactive materials are in this category. Examples include chemical plants, pharmaceutical manufacturing facilities, certain laboratories, refineries, hazardous waste and disposal sites, and above-ground gasoline storage or sales centers.

**At-Risk Populations:** Examples of facilities with at-risk populations include nursing homes, day care and assisted living for 12 or more individuals, pre-schools, and K-12 schools.

**Vital to Restoring Normal Service:** Facilities in this category include government operation (such as courts, jails, building permitting, and maintenance facilities) and essential structures for public colleges and universities (dormitories, office and classrooms).

The local jurisdiction having land use authority has the responsibility of identifying Critical Facilities in a community. Key components of the Critical Facility regulations include: 1) communities are encouraged to limit development of Critical Facilities within the 500-year floodplain, where possible, 2) all new and substantially changed critical facilities located within the 100-year floodplain shall have 2 feet of freeboard (instead of 1 foot), and 3) ingress and egress for new critical facilities shall have continuous non-inundated access for evacuation and emergency services.



**Criteria for Determining the Effects of Levees on Regulatory Floodplains:** Both UDFCD and CWCB discourage the use of levees for property protection, flood control, and flood hazard mitigation, unless other mitigation alternatives are not viable. Levees should not be constructed for the primary purpose of removing undeveloped lands from mapped floodplain areas for the purposes of developing those lands because of the potential impairment of the health, safety, welfare and property of the people. Design and construction of levees identified for this purpose are not eligible for UDFCD maintenance or for CWCB grants or loans. The Rule also provides requirements for mapping areas protected by levees, levee maintenance, ownership, freeboard, interior drainage, human intervention and operation, and analysis.

**Recommended Activities for Regulatory Floodplains:** The CWCB lists numerous floodplain management activities and actions to increase a community's overall level of flood protection. These suggestions include, but are not limited to, the following practices:

- Adopting local standards above and beyond the FEMA and CWCB minimum requirements,
- Enrolling in the NFIP and the Community Rating System programs,
- Developing early warning flood detection systems,
- Educating real estate and lending professionals about state and federal requirements,
- Advising the public that floods greater than the 100- and 500-year events do occur, and
- Prohibiting the construction of new levees that are intended to remove land from a regulatory floodplain for the purpose of allowing new development to occur.

## **6.0 Floodproofing**

### **6.1 Definition of Floodproofing**

Floodproofing is any combination of structural or nonstructural changes or adjustments incorporated in the design, construction, or alteration of individual buildings or properties that will reduce damage from flooding.

### **6.2 Scope of Floodproofing Guidance Provided**

The primary focus of this section is on floodproofing commercial, institutional and critical facilities (public works projects). This section is not intended to address residential floodproofing.

For general guidance on residential floodproofing measures, FEMA has prepared the “Homeowner’s Guide to Retrofitting,” available online at: <http://www.fema.gov/library/viewRecord.do?id=1420>. Avoidance of development in floodplains is the preferred approach for flood risk management for residential development.

### **6.3 Typical Causes of Flooding**

Flooding in the UDFCD region typically results from heavy rains during the spring and summer months. Intense rainfall can lead to flooding and, in general terms, is exacerbated by increased impervious cover associated with urban development. Typical causes of flooding are described in the following sections.

#### **6.3.1 Inadequate Street Conveyance**

As discussed in the *Street, Inlets, and Storm Drains* chapter, the minor drainage system should be designed to convey flows generated by storms ranging between the 2-year and 10-year event. Over time, the street conveyance capacity can be diminished by pavement overlays that reduce the gutter depth and alter the design slopes. As a result, even during minor storms, water can pond or exceed the gutter capacity and result in localized flooding.

#### **6.3.2 Inadequate Storm Drain Conveyance**

Older sections of the metropolitan area have storm drain systems that were constructed prior to the development of current drainage criteria. In many cases, capacity is limited to the 2-year, or more frequent, design storm. A less frequent storm event, such as the 5-year event, has larger flows and could cause surcharging in the storm drains and the occurrence of localized flooding.

#### **6.3.3 Inadequate Channel Conveyance**

Prior to the development of current floodplain and drainage criteria, development often encroached on natural streams which resulted in reduced conveyance capacity. Overbank flooding is the most dangerous type because of the combination of velocity and depth of floodwaters. Adherence to a community’s floodplain requirements is important. The goals of these requirements include limiting development within the floodplain and restricting development within the floodway.

### 6.3.4 Sewage Backup

Flooding can inundate and overload sanitary sewer systems. As a result, water can flow backward through sewer lines and out through toilets or floor drains. Protection against sewage backup is typically addressed with the installation of a backflow valve in the sanitary service line running from the house.

## 6.4 Factors That Affect Flooding Damage

Damage to structures from flooding is primarily determined by a combination of the following six factors:

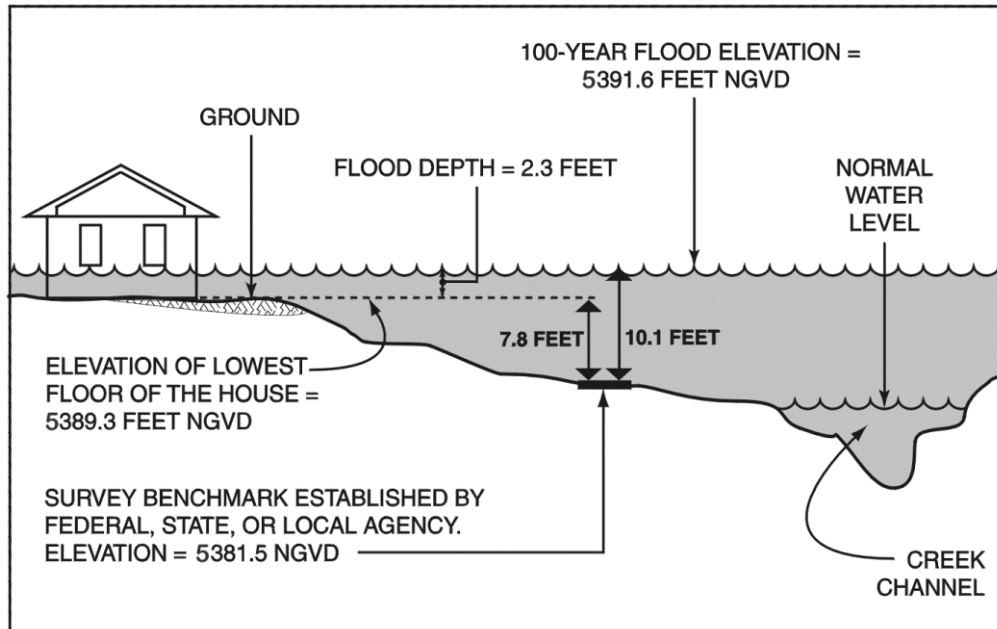
- Depth/elevation,
- Velocity of flow,
- Frequency of occurrence,
- Rates of rise and fall,
- Duration, and
- Debris impact.

Each of these factors is described further below.

### 6.4.1 Depth/Elevation of Flooding

The depth and elevation of flooding are closely related and are viewed as a single characteristic for the purpose of this discussion. Flood depth is the height of the floodwater above the surface of the ground or other feature at a specific point. Flood elevation is the height of the floodwater above an established reference datum. The standard datums used by most federal agencies and many state and local agencies are the National Geodetic Vertical Datum (NGVD) and the North American Vertical Datum (NAVD), though other datums are also used.

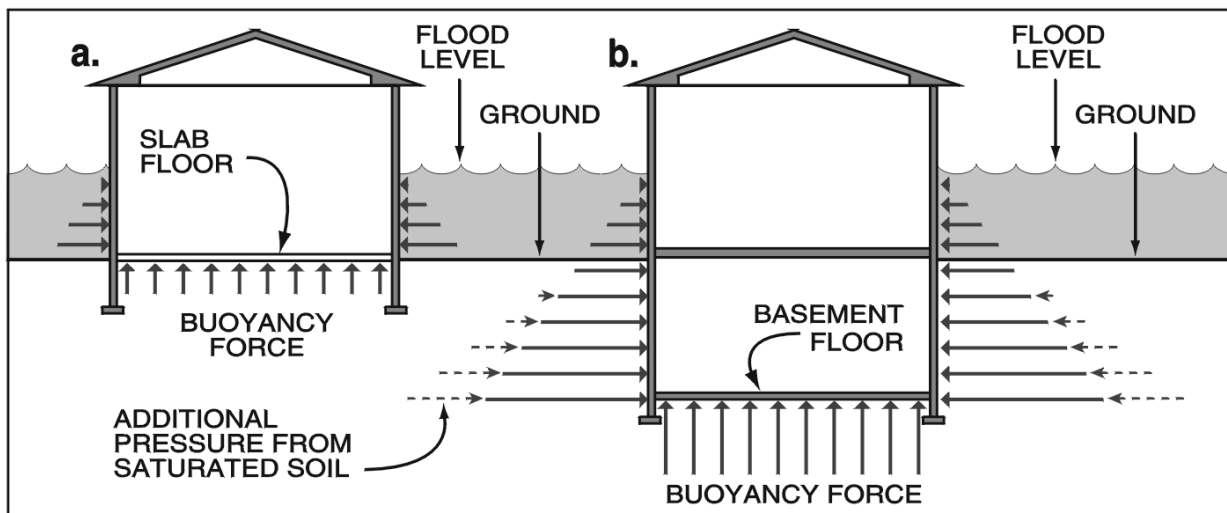
Whereas ground elevations are established by surveys, flood elevations may be calculated or surveyed from watermarks left by floods. Elevations of the ground, floodwaters, and other features cannot be meaningfully compared with one another unless they are based on the same datum. The flood depth at any point is equal to the flood elevation minus the elevation of the reference point (such as the ground or the lowest floor of the building), assuming that all elevations are based on the same datum. Figure 4-3 illustrates this relationship.



**Figure 4-3. Schematic representation of flood depth and flood elevation**

The depth of water during a flood directly affects the forces exerted on the building, including buoyant forces and hydrostatics pressure, as illustrated below.

**Buoyant Force:** Water surrounding and underneath a building, such as situations where soils are saturated around a basement or crawl space, creates a buoyant force upward on the floor slab, as shown in Figure 4-4. The buoyant force is directly related to the depth of water above the elevation of the floor slab.

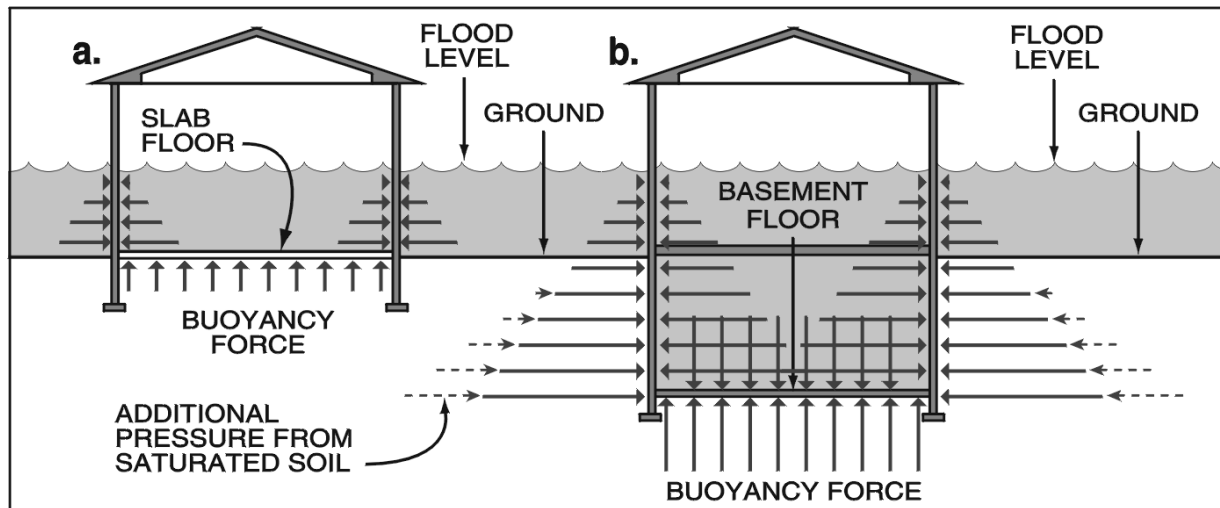


**Figure 4-4. Buoyant force and hydrostatic pressure diagram**

**Hydrostatic Pressure:** Hydrostatic pressure is applied horizontally to walls that are submerged below the water surface, as shown in Figure 4-4. The amount of hydrostatic pressure increases with the water depth, and therefore the pressure on basement walls is greater than the pressure on the walls of the upper

floor, as represented by the arrows in the figure. The horizontal pressure on basement walls is made even greater by the weight of the saturated soil that surrounds the basement. Extensive structural damage can occur, and possible collapse of the building, if the horizontal pressure exceeds the strength of the walls.

Note that in Figure 4-4, no water is shown inside the building. If water is allowed to enter, as shown in Figure 4-5, the hydrostatic pressures on both sides of the walls and floor are equalized, and the walls are much less likely to collapse and fail.



**Figure 4-5. Hydrostatic pressure with wet floodproofing**  
(allowing flood waters to enter building)

### 6.4.2 Flow Velocity

Flow velocities during riverine floods can reach 5 to 10 feet per second (ft/sec), and may be greater in some situations. For reference, 10 ft/sec is roughly equivalent to 7 miles per hour.

The velocity of riverine floodwaters depends primarily on two factors: 1) the longitudinal slope of the channel/floodplain, and 2) the roughness of the channel/floodplain. As expected, flow rates are more rapid in steep floodplains and in floodplains that are relatively smooth (e.g., over parking lots) rather than rough (i.e., covered with large rocks, trees, dense vegetation, or other obstacles). Also, flow velocities in the floodplain are typically higher near the center of the main channel than at the outermost fringes, where velocities are slower.

If a structure is located where floodwaters are moving, the flow velocity influences the potential amount of structural damage incurred, particularly if the velocity exceeds approximately 5 ft/sec. The force exerted by flowing water, referred to as hydrodynamic pressure, is added to the hydrostatic pressure from the floodwater against the walls of the building. In addition to the hydrodynamic and hydrostatic forces, flow along the sides of a building creates friction that can damage wall coverings, such as siding. On the downstream side of the building, away from the flow, the water creates a suction force that pulls on walls (see Figure 4-6). In some situations, the combination of these forces can destroy one or more walls and cause the building to shift on its foundation or even be swept away.

Flowing water can also cause erosion and scour around objects that obstruct flow, such as foundation walls. Both erosion and scour can weaken the structure by removing supporting soil and undermining the foundation. In general, the greater the flow velocity and larger the building, the greater the extent and depth of erosion and scour. Also, any objects carried by floodwaters will be moving at roughly the same speed as the water.

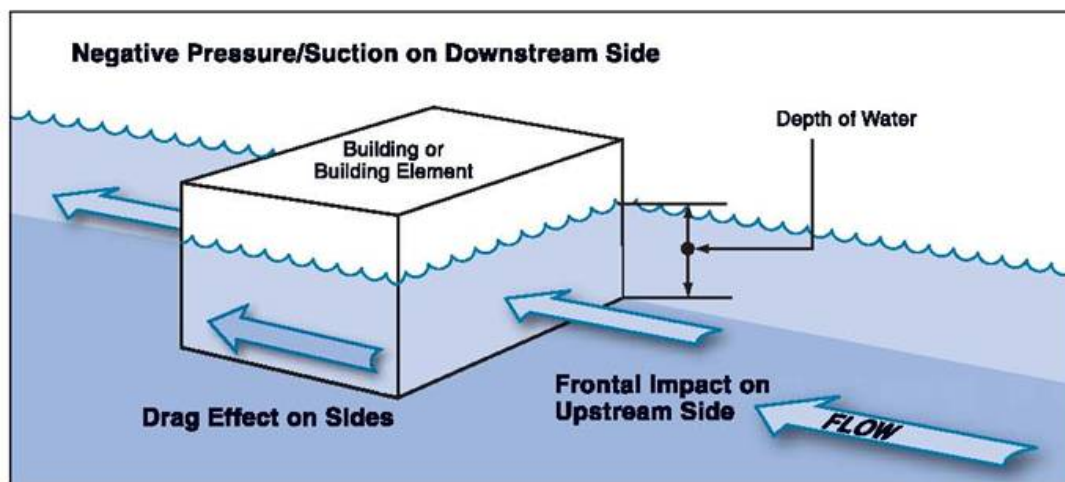


Figure 4-6. Effects of moving water on a structure

### 6.4.3 Flood Frequency

Flood frequencies are usually determined through statistical analyses performed by engineers, floodplain management agencies and other organizations as a basis for engineering designs and flood insurance rates. Those analyses define the probability, expressed as a percentage, that a flood of a specific magnitude will be equaled or exceeded in any year.

As previously noted, the 100-year flood is particularly important because it serves as the basis of the NFIP flood insurance rates and regulatory floodplain management. The 100-year flood is also referred to as the 1% annual exceedance probability flood (i.e., it has a 1% chance of being exceeded in a single year).

#### **6.4.4 Rates of Rise and Fall**

The rates of rise and fall refer to how rapidly the depth of floodwaters increase and decrease during a flood. Floodwaters with high flow velocities, such as those associated with steep terrain or caused by the failure of a dam or levee, usually rise and fall more rapidly than slower-moving floodwaters, as in gently sloping floodplains. The rate of rise is important because it affects the amount of warning prior to an impending flood. In floodplains of streams with high rates of rise, homeowners may have little notice of a coming flood, perhaps only hours, or none at all in some cases. If the flood protection method for a property involves contingent measures that a property owner must implement prior to the floodwaters arriving, the amount of warning time is especially important.

The rate of rise and rate of fall are also important because of their effect on hydrostatic pressure. As discussed previously, hydrostatic pressure is greatest when the water level outside the building is significantly different than the water level inside the building and, hence, the internal and external pressures are not equalized. When floodwaters rise rapidly, water may not flow into a building quickly enough for the level inside the building to rise at the same rate as the level outside. Conversely, when floodwaters fall rapidly, water that has filled a building may not flow out quickly enough, resulting in higher pressure inside the building than outside. In either situation, the unequal hydrostatic pressures can cause structural damage.

#### **6.4.5 Duration**

Duration is related to the rates of rise and fall. Relative to a flood, duration is the amount of time it takes for the source of the flood (i.e., river, creek) to return to its normal level. Generally, water that rises rapidly will recede more rapidly, and water that rises slowly will recede more slowly. Duration is important because it determines how long the structural members (e.g., foundation, floor joists, wall studs), interior finishes (e.g., drywall and paneling), service equipment (e.g., furnaces and hot water heaters), and building contents will be affected by floodwaters. Long periods of inundation are more likely to cause damage than short periods. In addition, long-duration flooding can saturate soils as shown on Figure 4-4, resulting in increased pressure on the foundation. Duration also affects how long a building remains uninhabitable.

#### **6.4.6 Impact of Debris and Contaminants in Floodwaters**

Floodwaters can carry debris of all types, including trees, automobiles, boats, storage tanks, mobile homes, and even entire buildings. All of these add to the dangers of flooding. Even when flow velocity is relatively low, large objects carried by floodwaters can easily damage windows, doors, walls, and, more importantly, critical structural components of a building. As velocity increases, so does the danger of greater damage from debris.

Contaminants in floodwaters, in addition to sediment, frequently include substances such as oil, gasoline, sewage, and various chemicals. If floodwaters carrying large amounts of dirt or hazardous substances enter a building, cleanup costs are likely to be higher and cleanup time greater.

## 6.5 Classes of Floodproofing Techniques

Floodproofing techniques are classified based on the type of protection provided:

- **Permanent measures:** Always in place and require no action if flooding occurs.
- **Contingent measures:** Require installation prior to the occurrence of a flood.
- **Emergency measures:** Improvised at the site when flooding occurs.

In the Denver metropolitan area, floodproofing efforts should focus on permanent measures because most of the stream systems respond rapidly to intense rainfall events. Contingent measures are more effective when combined with an early flood warning system or in areas not immediately adjacent to a stream channel.

Most floodproofing methods are more appropriate only where floodwaters are less than 3 feet deep. At depths greater than 3 feet, walls and floors are more likely to collapse because of the higher water pressure.

## 6.6 Floodproofing Methods

For new development, the first option for flood risk management should always be to construct outside of the floodplain. If building outside the floodplain is impractical for a site, then the structure should be constructed in compliance with local floodplain regulations. The remaining floodproofing methods discussed in this chapter are primarily for retrofitting existing structures.

### 6.6.1 Overview of FEMA Methods

Most regulations for floodproofing are based on the minimum NFIP standards for constructing, modifying, or repairing buildings located in the floodplain. FEMA has published numerous references on the subject of floodproofing methods (FEMA 1984, 1986a, 1986b, 1991, 1993a, 1993b, 1993c, 1993d, 1993e, 1994, 1995, 1996, 1998, 2000, 2001, 2008, 2009), several of which list six specific methods. Three of the methods can be used to meet NFIP residential floodproofing requirements. The other three do not meet the minimum NFIP requirements, but can be used to minimize damages, as listed below:

Methods that can be used to meet NFIP residential floodproofing requirements:

**Elevation:** Raise the structure so the lowest floor is above the flood level.

**Relocation:** Move the structure out of the floodplain to higher ground where it will not be exposed to flooding.

**Demolition:** Tear down the damaged structure and either: a) properly rebuild the structure on the same property, or b) buy or build a structure outside the floodplain.

Methods that cannot be used to meet NFIP residential floodproofing requirements:

**Dry floodproofing:** Seal the structure to prevent floodwaters from entering.



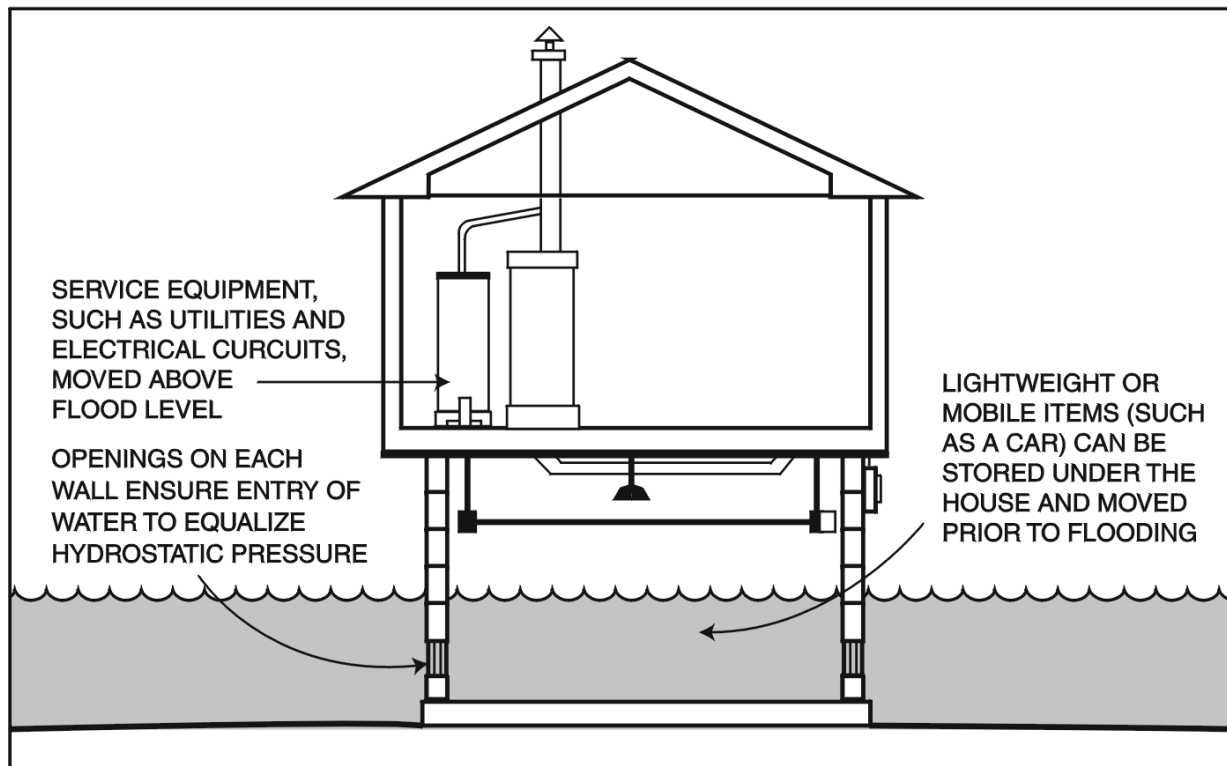
**Levees and floodwalls:** Build a physical barrier around the structure to hold back floodwater.<sup>1</sup>

**Wet floodproofing:** Make uninhabited portions of the structure resistant to flood damage and allow water to enter during flooding (cannot be used to meet NFIP requirements for residential floodproofing).

Sections 6.6.2 through 6.6.7 provide descriptions of each of the six floodproofing methods identified by FEMA, their respective advantages and disadvantages, and where they are appropriate to apply.

### 6.6.2 Elevation

Elevating a building to prevent floodwaters from reaching living areas is an effective retrofitting method. The goal of the elevation process is to raise the lowest floor to a level at or above the flood protection elevation (FPE). This can be achieved by elevating the entire building, including the floor, or by leaving the building in its existing position and constructing a new, elevated floor within the building. See figure 4-7. The method used depends largely on the construction type, foundation type, and flooding conditions.



**Figure 4-7. Example of a structure elevated on continuous foundation walls**

<sup>1</sup> In February 2007, the UDFCD Board of Directors adopted a levee policy which discourages local governments from authorizing or permitting levees for new development and states that such levees would not be eligible for UDFCD maintenance assistance. The policy will allow the use of levees as a last resort to protect existing structures.

During the elevation process, most buildings are separated from their foundations, raised on hydraulic jacks, and held by temporary supports while a new or extended foundation is constructed below. This method works well for buildings originally built on basements, crawl spaces, or open foundations. The new or extended foundation can consist of continuous walls or separate piers, posts, columns, or pilings.

A variation of this method is used for buildings with slab-on-grade foundations, where the slab forms both the foundation and the floor of the building. Elevating that type of structure is easier if the building is left attached to the slab foundation and both are lifted together. After the building and slab are lifted, a new foundation is constructed below the slab.

In cases where the building is on an open foundation, it can be elevated with piers, columns, or piles. Piers should be properly anchored to footings. Columns are typically braced members but also need to be properly anchored.

Alternative techniques are available for masonry buildings on slab-on-grade foundations. These techniques do not require the lifting of the building. Instead, they involve raising the floor within the building or moving the living space to an upper story.

Although elevating a building can help protect it from floodwaters, other factors need to be considered before choosing this method. For example, the walls and roof of an elevated building may be more susceptible to wind forces because they are higher and more exposed. In addition, continuous wall foundations and open foundations both can fail as a result of damage caused by erosion and the impact of debris carried by floodwaters. If portions of the original foundation, such as the footings, are used to support new walls or other foundation members or a new second story, they must be capable of safely carrying the additional loads imposed by the new construction as well as any additional loads generated by wind or flood waters.

Advantages and disadvantages of the elevation method of floodproofing are summarized in Table 4-2.

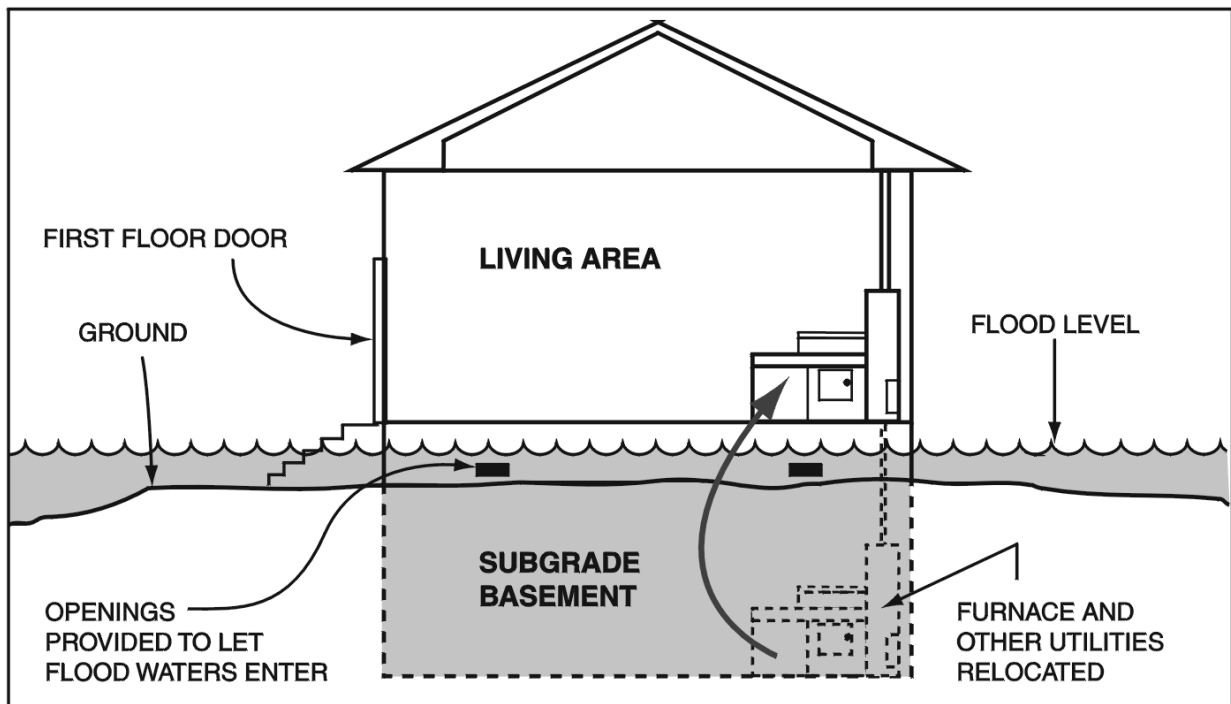
**Table 4-2. Advantages and disadvantages of the elevation method**

Advantages	Disadvantages
<p>Raising the floor elevation to or above the FPE allows a substantially damaged or substantially improved building to be brought into compliance with the community’s floodplain management ordinance or law<sup>1</sup>.</p> <p>The elevation method does not require the additional land that may be needed for construction of floodwalls or levees.</p> <p>Except where a lower floor is used for storage, the elevation method eliminates the need to move vulnerable contents to areas above the water level during flooding.</p> <p>The elevation method often reduces flood insurance premiums.</p> <p>Elevation techniques are well known, and qualified contractors are often readily available.</p>	<p>Cost may be prohibitive.</p> <p>The appearance of the building may be adversely affected.</p> <p>Access to the building may be adversely affected.</p> <p>The building must not be occupied during a flood.</p> <p>Unless special measures are taken, elevation is not appropriate in areas with high-velocity flows, waves, fast-moving ice or debris flow, or erosion.</p> <p>Additional costs are likely if the building must be brought into compliance with current code requirements for plumbing, electrical, and energy systems.</p> <p>Potential wind and earthquake loads must be considered.</p>

<sup>1</sup> Verify all requirements when applying for the floodplain permit.

### 6.6.3 Wet Floodproofing

Wet floodproofing a building is accomplished by modifying the uninhabited portions of the structure (such as the crawl space or unfinished basement) to enable floodwaters to enter without causing significant damage to either the building or its contents. The purpose of allowing water to enter portions of the building is to equalize the interior and exterior hydrostatic pressures, thereby reducing the likelihood of wall failures and structural damage (see Figure 4-8). Wet floodproofing is practical in only a limited number of situations and is typically used when all other retrofitting methods are either too costly or are not feasible.



**Figure 4-8. Example of building with wet floodproofed subgrade basement**

Because wet floodproofing allows floodwaters to enter the building, all construction and finishing materials below the FPE must be resistant to flood damage. For this reason, wet floodproofing is practical only for portions of a building that are not used for living space, such as a basement as defined by the NFIP regulations, a walkout-on-grade basement, crawl space, or attached garage. It would not be practical for most slab-on-grade buildings, in which the living space is at or very near the ground level. Whether or not wet floodproofing is appropriate for a building will depend on the flood conditions, the FPE selected, the design and construction of a building, and whether the building has been substantially damaged or is being substantially improved.

Advantages and disadvantages of wet floodproofing are summarized in Table 4-3.

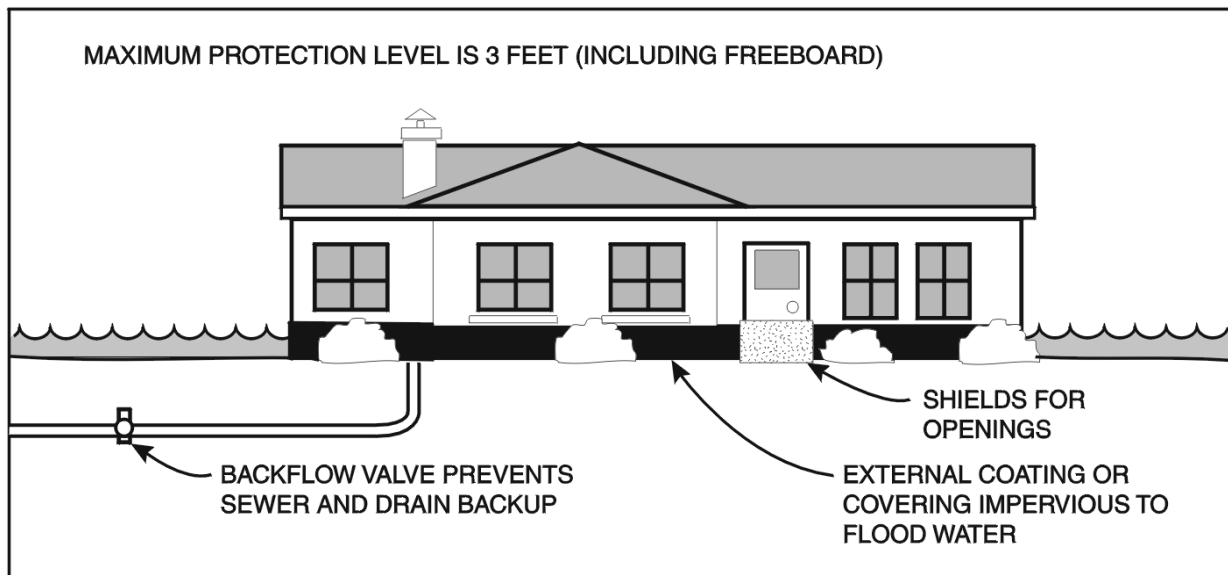
**Table 4-3. Advantages and disadvantages of wet floodproofing**

Advantages	Disadvantages
<p>Wet floodproofing can, in many instances, reduce structural damage to a building.</p> <p>Because wet floodproofing allows internal and external hydrostatic pressures to equalize, the loads on walls and floors will be less than in a dry floodproofed building.</p> <p>Flood insurance will cover the costs in some instances for moving or storing contents (except basement contents) after a flood warning is issued.</p> <p>Wet floodproofing measures are often less costly than other types of retrofitting.</p> <p>Wet floodproofing does not require the additional land that may be needed for floodwalls and levees.</p> <p>The appearance of the building is usually not adversely affected.</p>	<p>Wet floodproofing may be used to bring a substantially damaged or substantially improved building into compliance with a community's floodplain management ordinance or law only if the areas of the building below the FPE are used solely for parking, storage, or building access.</p> <p>Preparing the building and its contents for an impending flood requires adequate warning time and human intervention.</p> <p>A building with wet floodproofing will get wet inside and possibly contaminated by sewage, chemicals, and other materials conveyed in floodwaters. Extensive cleanup may be necessary.</p> <p>Periodic maintenance of wet floodproofing measures is likely necessary.</p> <p>The building must not be occupied during a flood, and it may be uninhabitable for some time afterward.</p> <p>Uses in the floodable area of the building must be limited.</p> <p>Pumping floodwaters out of a wet floodproofed basement too soon after a flood may lead to structural damage.<sup>1</sup></p> <p>Wet floodproofing does not minimize the potential damage from high-velocity flood flow and wave action.</p>

<sup>1</sup>**WARNING.** After floodwaters recede from the area around a building with a wet floodproofed basement, the owner will usually want to pump out the water that filled the basement during the flood. If the soil surrounding the basement walls and below the basement floor is still saturated with water, however, removing the water in the basement too quickly can be dangerous. As the water level in the basement drops, the outside pressure on the basement walls becomes greater than the inside pressure and damage can result (e.g., the walls can collapse and/or the floor can be pushed up or cracked).

### 6.6.4 Dry Floodproofing

In some situations, a building can be made watertight below the FPE, so that floodwaters cannot enter. This method is called dry floodproofing. Making a building watertight requires sealing the walls with waterproof coatings, impermeable membranes, or supplemental layers of masonry or concrete. Also, doors, windows, and other openings below the FPE must be equipped with permanent or removable shields, and backflow valves must be installed in sewer lines and drains (see Figure 4-9). Flood characteristics that affect the success of dry floodproofing are flood depth, flood duration, flow velocity, and the potential for wave action and flood-borne debris.



**Figure 4-9. Example of a dry floodproofed structure**

Flood depth is important because of the hydrostatic pressure that floodwaters exert on walls and floors. Since water is prevented from entering a dry floodproofed building, the exterior pressure on walls and floors is not counteracted as it is in a wet floodproofed building. The ability of building walls to withstand the pressure exerted by floodwaters depends in large part on their construction. Typical masonry and masonry veneer walls, without reinforcement, can usually withstand the pressure exerted by water up to about 3 feet deep. When flood depths exceed 3 feet, unreinforced masonry and masonry veneer walls are much more likely to crack or collapse. In addition, in most cases, the buoyancy force exerted by water with a depth greater than 3 feet is enough to crack a slab or push it up.

An advantage of masonry and masonry veneer walls is that their exterior surfaces are resistant to damage by moisture and can be made watertight relatively easily with sealants. In contrast, typical frame walls are likely to fail at lower flood depths, are more difficult to make watertight, and are more vulnerable to damage from moisture. As a result, it is not recommended to rely upon dry floodproofing for buildings with frame walls that will be damaged by moisture. Dry floodproofing is not an appropriate method to protect a residential structure from flood depths greater than 3 feet.

Dry floodproofing may not be used to bring a substantially damaged or substantially improved building into compliance with a community's floodplain management ordinance or law. Advantages and disadvantages of dry floodproofing are summarized in Table 4-4.

**Table 4-4. Advantages and disadvantages of dry floodproofing**

Advantages	Disadvantages
<p>Dry floodproofing prevents damage to the building interior, unlike some other methods (e.g., wet floodproofing, which does not protect the interior contents of the building from damage).</p> <p>Dry floodproofing may be less costly than other retrofitting methods.</p> <p>Dry floodproofing does not require the additional land that may be needed for levees and floodwalls.</p>	<p>Dry floodproofing may not be used to bring a substantially damaged or substantially improved building into compliance with a community's floodplain management ordinance or law.</p> <p>Ongoing maintenance of the dry floodproofing measures is required.</p> <p>Flood insurance premiums are not reduced for residential structures.</p> <p>Installing temporary protective measures, such as flood shields, requires adequate warning time and human intervention.<sup>1</sup></p> <p>If the protective measures fail or the FPE is exceeded, the effect on the building will be the same as if there were no protection at all.</p> <p>If design loads are exceeded, walls may collapse, floors may buckle, and the building may even float, potentially resulting in more damage than if the building was allowed to flood.</p> <p>The building must not be occupied during a flood.</p> <p>Flood shields may not be aesthetically pleasing.</p> <p>Damage to the exterior of the building and other property may not be reduced.</p> <p>Shields and sealants may leak, which could result in damage to the building and its contents.</p> <p>Dry floodproofing does not minimize the potential damage from high-velocity flood flow and wave action.</p>

<sup>1</sup>**WARNING.** Because dry floodproofing requires human intervention, one must be willing and able to install all flood shields and carry out all other activities required for the successful operation of the dry floodproofing system. As a result, not only must one be physically capable of carrying out these activities, one must be in the building or able to go there in time to do so before floodwaters arrive.

### 6.6.5 Relocation

Relocation, or moving a building to ground located outside the flood hazard area, is the most effective floodproofing method described in the USDCM. If space permits, it may be possible to move a building to another location on the same piece of property.

Relocating a building typically involves jacking the building up and placing it on a wheeled vehicle for transport to the new site. Since the original foundation cannot be moved, it is demolished and a new foundation is built at the new site. The building is installed on the new foundation and utility lines are connected.

Relocation is particularly appropriate in areas where the flood hazard is severe. Severe flood hazards are often characterized by deep water, rapid rates of rise and fall, short warning times, wave action, high flow velocities, high debris flow, and long durations. Relocation is also appropriate for those who want less worry about damage from future floods that may exceed a specific FPE.

Although similar to the elevation floodproofing method, relocation requires additional steps that typically make it more expensive. These steps include moving the building, buying and preparing a new site (including building the new foundation and providing the necessary utilities), and restoring the old site (including demolishing the old foundation and properly capping and abandoning old utility lines).

Advantages and disadvantages of relocation are summarized in Table 4-5.

**Table 4-5. Advantages and disadvantages of relocation**

Advantages	Disadvantages
Relocation allows a substantially damaged or substantially improved building to be brought into compliance with a community's floodplain management ordinance or law.	Relocation costs may be prohibitive. A new site (preferably outside the flood hazard area) must be located and purchased.
Relocation significantly reduces flood risk to the building and its contents.	The flood-prone lot on which the building was formerly located must be sold or otherwise disposed of.
Relocation can either eliminate the need to purchase flood insurance or reduce the amount of the premium.	Many types of buildings are not suitable for being relocated.
Relocation techniques are well known, and qualified contractors are often readily available.	Additional costs are likely if the building must be brought into compliance with current code requirements for plumbing, electrical, and energy systems.



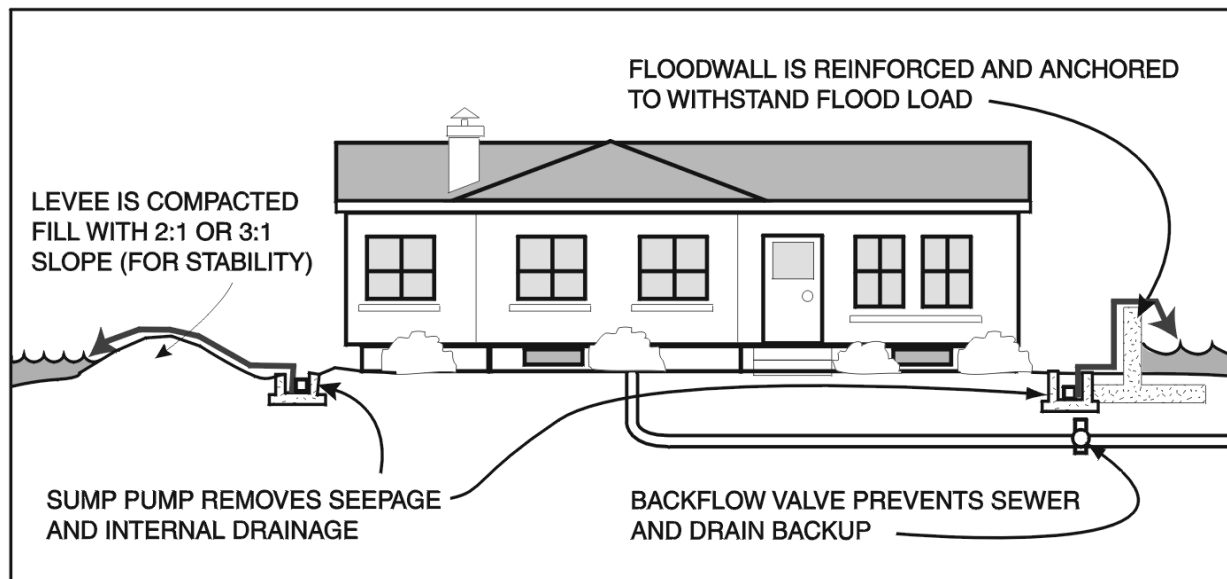
### 6.6.6 Levees and Floodwalls

Levees and floodwalls are both types of flood protection barriers. However, it is important to recognize that both CWCBC and UDFCD discourage the use of levees. In 2007, UDFCD formally adopted a levee policy which discourages local governments from authorizing or permitting levees for new development and states that these levees will not be eligible for UDFCD maintenance assistance. The policy will allow the use of levees as a last resort to protect existing structures.

A levee is typically a compacted earthen structure; a floodwall is an engineered structure typically constructed of concrete, masonry, or a combination of both (see Figure 4-10). When these barriers are built to protect a building, they are usually referred to as residential, individual, or on-site levees and floodwalls. The practical heights of levees and floodwalls are usually limited to 6 feet and 4 feet, respectively. These limits are the result of the following considerations:

As the height of a levee or floodwall increases, so does the depth of water that can build up behind it. Greater depths result in greater water pressures. Taller levees and floodwalls must be designed and constructed to withstand the increased pressures. Meeting this need for additional strength greatly increases the cost of the levee or floodwall, usually beyond what an individual homeowner can afford.

Since taller levees and floodwalls must be stronger, they occupy more space and typically require more space than is likely to be available on an individual residential lot. This is especially true of levees.



**Figure 4-10. Example of levee and floodwall protection**

Both levees and floodwalls should be constructed to provide at least 3 feet of freeboard above the BFE. Levees do not meet federal requirements for flood protection if they do not extend 3 feet above the BFE.

**Levees:** For a levee to be effective over time, it must be constructed of soils that cannot be easily penetrated by floodwaters. Furthermore, it must have proper side slopes for stability and it must be periodically inspected and maintained. In areas where flow velocities are sufficient to cause erosion, the side of the levee exposed to floodwater is usually protected with riprap or other erosion-resistant material. Levees can surround a building, or they may be built only across low areas and tied into existing high ground.

**Floodwalls:** A floodwall can surround a building, or depending on flood depths, site topography, and design preferences, it can protect isolated openings such as doors, windows, and basement entrances, including entry doors and garage doors in walkout-on-grade basements. Per unit length, floodwalls are typically more expensive than levees. Consequently, floodwalls are normally considered only for sites where there is not enough room for a levee or where high flow velocities may erode a levee.

As discussed previously, levees and floodwalls are discouraged by both the CWCB and the UDFCD. They are considered to be floodproofing measures of last resort. Recognizing this, their relative advantages and disadvantages are listed in Table 4-6.

**Table 4-6. Advantages and disadvantages of levees and floodwalls**

(Note: Levees and floodwalls are both considered to be floodproofing measures of last resort.)

Advantages	Disadvantages
<p>Levees and floodwalls provide protection from inundation to the building and area around it (provided that the design flood is not exceeded). No significant changes to the building are required.</p> <p>Floodwaters are prevented from reaching the building or other structures in the protected area and therefore prevent damage from inundation, hydrodynamic pressure, erosion, scour, or debris impact.</p> <p>The building can be occupied during construction of levees and floodwalls.</p>	<p>The use of levees for property protection, flood control, and flood hazard mitigation is discouraged by the CWCB. Levees should be considered only if other mitigation alternatives are not viable.</p> <p>The UDFCD Board of Directors adopted a levee policy in February 2007 which discourages local governments from authorizing or permitting levees for new development. The policy states that new levees will not be eligible for UDFCD maintenance assistance. The policy will allow the use of levees as a last resort to protect existing structures.</p> <p>Levees and floodwalls may not be used to bring a substantially damaged or substantially improved building into compliance with a community’s floodplain management ordinance or law.</p> <p>Costs may be prohibitive.</p> <p>Periodic maintenance is required.</p> <p>Adequate warning time and human intervention are required to close any openings in a levee or floodwall.</p> <p>If a levee or floodwall fails or is overtopped by floodwaters, the effect on the building will be the same as if there were no protection at all.</p> <p>An interior drainage system must be provided.</p> <p>Local drainage can be affected, possibly creating or worsening flood problems for others.</p> <p>The building must not be occupied during a flood.</p> <p>A levee or floodwall may restrict access to the building.</p> <p>Levees and floodwalls do not reduce flood insurance rates.</p> <p>Floodplain management requirements may make levees and floodwalls violations of codes and/or regulations.</p> <p>A large area may be required for construction, especially for levees.</p> <p>Hydrostatic pressure on below-ground portions of a building may still be a problem, making levees and floodwalls an undesirable option for buildings with basements.</p>

### **6.6.7 Demolition**

Demolition, as a floodproofing method, involves tearing down a damaged building and either rebuilding properly (i.e., compliant with floodplain regulations) somewhere on the same property or moving to a building on other property outside the regulatory floodplain. This retrofitting method may be the most practical of all those described in the USDCM when a building has sustained extensive damage, especially if severe structural damage has occurred.

Whether rebuilding or moving, the damaged building must be torn down and the site restored. Site restoration generally involves filling in the basement or foundation, grading the site, and landscaping. The services of demolition and grading contractors will likely be required. All demolition, construction, and site restoration work must be done according to the regulatory requirements of the community. Permits may be required for all or part of this work.

The advantages and disadvantages of demolition depend on the decision regarding where to rebuild the structure.

## **6.7 Engineering Considerations for Floodproofing Methods**

Engineering considerations for a proposed floodproofing method include evaluating the site and building characteristics, determining the flooding characteristics, and analyzing the potential loads on the structure during a flood event. These topics are addressed in Sections 6.7.1 through 6.7.3.

### **6.7.1 Flood Hazard Analysis**

Determining the potential depth of flooding is the first and most logical step in assessing flood hazards, since it is often the primary factor in evaluating the potential for flood damage. The depth of flooding is also critical in determining the extent of retrofitting that will be needed and which method(s) will be the most appropriate for a given site. Detailed flood information is provided in the FIS and FIRM where such studies are available and can be obtained from the FHAD.

The second step in assessing flood hazards is to calculate the forces acting upon a structure during a flood. These forces include hydrostatic, hydrodynamic, and impact loads. Hydrostatic forces include lateral water pressure, saturated soil pressures, combined water and soil pressures, equivalent hydrostatic pressures due to low velocity flows (< 10 ft/sec), and buoyancy pressures. Hydrodynamic forces consist of frontal impact by the mass of moving water against the projected width and height of the obstruction represented by the structure, drag effect along the sides of the structure, and eddies or negative pressures on the downstream side of the structure. Impact loads are imposed on the structure by objects carried by moving water.

### 6.7.2 Site Characteristics

Important site characteristics to evaluate include the location of the structure relative to sources of potential flooding and geotechnical considerations. The site location should be evaluated with respect to mapped floodplains and floodways and the potential for local flooding from stormwater conveyance elements.

Soil properties during conditions of flooding are important factors in the design of any surface intended to resist flood loads. These properties include saturated soil pressures, allowable bearing capacity, potential for scour, frost zone location, permeability, and shrink-swell potential.

### 6.7.3 Building Characteristics

The building should be evaluated with respect to the type of construction and the condition of the structure. The type of foundation, foundation materials, wall materials, and the method of connection all play a role in deciding which retrofitting method is most applicable. Operations involving a building in poor condition may further damage the building and result in costs that exceed its original value.

## 6.8 Selection of Floodproofing Method

In addition to engineering considerations described above, selection of the floodproofing method depends on several factors described below:

### 6.8.1 Regulatory Considerations

Federal, state, and local regulations may restrict the choice of retrofitting measures. Such regulations may include state and local building codes, floodplain management ordinances or laws, zoning ordinances, federal regulations concerning the alteration of buildings classified as historic structures, deed restrictions, and the covenants of homeowners associations.

**Federal Regulations:** The NFIP limits certain types of floodproofing. For example, the NFIP prohibits obstructions, such as berms and floodwalls, in floodways. The NFIP also requires floodproofing for buildings that are substantially improved or substantially damaged. “Substantially damaged” is defined as “damage of any origin sustained by a structure whereby the cost of restoring the structure to its prior condition would equal or exceed 50 percent of the market value of the structure before the damage occurred.” Buildings that have been substantially damaged or are being substantially improved (renovated) must be elevated to a level at or above the 100-year flood level. Nonresidential buildings must be elevated or dry floodproofed.

Other federal agencies, such as the U. S. Army Corps of Engineers (USACE), U. S. Geological Survey, and Natural Resources Conservation Service, also publish floodproofing information, as do some state and local agencies. The USACE provides engineering and construction standards in the publication *Floodproofing Regulations* (1995b). Additional USACE publications (1984, 1988, 1990, 1993, 1994, 1995a, 1996, 1998) provide information on case studies and detailed engineering applications of floodproofing methods.

**State and Local Regulations:** State and local regulations may require a retrofitted building to be upgraded to meet current code requirements, unrelated to the floodproofing measures. Examples of potentially required upgrades include the electrical, plumbing, and/or the heating/ventilation/air conditioning systems (e.g., an electrical panel might require an upgrade from fuses to circuit breakers). These changes are required for the safety of the homeowner. Other code-required upgrades include those

necessary for increased energy efficiency. Any required upgrade can add to the scope and cost of the retrofitting project.

Every community that is a member of the NFIP must adopt minimum NFIP requirements. Many communities choose to adopt ordinances which are stricter than the minimum requirements of the NFIP. The local government floodplain administrator can identify the ordinances that apply to a specific project.

### **6.8.2 Appearance**

Following retrofitting, the final appearance of a building and property will depend largely on the retrofitting method used and the FPE. For example, elevating a building several feet will change its appearance much more than elevating it only 1 or 2 feet. Also, a building elevated on an open foundation will appear much different than one elevated on extended foundation walls.

### **6.8.3 Accessibility**

Accessibility refers to the ease with which a building can be accessed after a retrofitting project is completed. The retrofitting methods described in the USDCM affect accessibility in different ways. For example, elevating a building will usually require the addition of stairs, which may be unacceptable to some. Wet floodproofing will have little, if any, effect on accessibility. The effect of relocation on accessibility will depend on the location and configuration of the new site.

### **6.8.4 Requirement for Human Intervention**

Retrofitting methods that require human intervention make it necessary for owners to be willing, able, and prepared to take the necessary action, such as placing flood barriers across the doors of a dry floodproofed building or operating a closure mechanism in a floodwall. These actions require that the owner have adequate warning of a coming flood and be able to reach the building and take action before floodwaters arrive. If these conditions cannot be met, retrofitting methods that require human intervention should be eliminated from consideration.

### **6.8.5 Benefit/Cost Analysis**

The cost of retrofitting will depend largely on the retrofitting method used and the FPE. For some methods, the construction type (frame, masonry, etc.) and foundation type (crawl space, slab, etc.) will also affect the cost. In general, costs will increase as the FPE increases, but there may be tradeoffs between alternative methods. For example, elevating may be less expensive than relocating when a building is raised only 1 or 2 feet but may become more expensive at greater heights. The benefits considered in a floodproofing measure are the future damages and losses that are expected to be avoided as a result of the measure.

### **6.8.6 Other Considerations**

Building owners may need to consider other factors, such as the availability of federal, state, and local financial assistance; the current value of the building versus the inconvenience and cost of retrofitting; the amount of time required to complete the retrofitting project; and the need to move out of the building during construction (including the availability and cost of alternative housing).

### 6.9 Cases Where Floodproofing is Not Appropriate

Except for demolition and relocation, floodproofing methods should not be considered in certain situations. For example, structures located within a regulatory floodway cannot be retrofitted with any substantial improvements that would result in an increase in flood levels during the base flood discharge. Under these conditions, the structure should be relocated out of the floodway and, preferably, out of the floodplain.

## 7.0 Assistance for Property Owners

### 7.1 Decision-Making Process for Property Owners

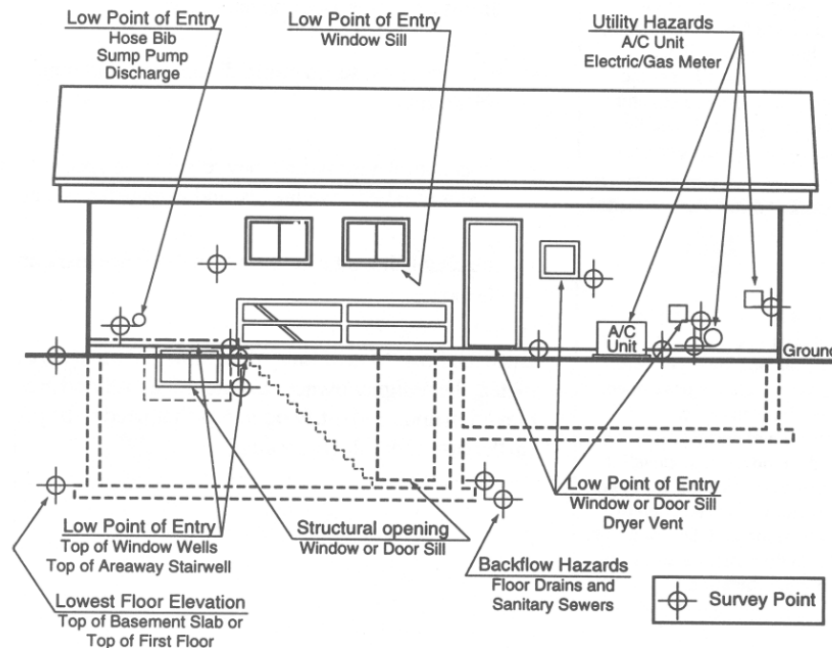
The decision regarding which floodproofing method to use will be based mainly on a combination of legal requirements, the technical limitations of the methods, and cost. Other considerations include the appearance of the building after retrofitting and any inconvenience resulting from retrofitting.

#### 7.1.1 Identification of Flood Hazards

Information about flood hazards in a specific area is available from UDFCD and local community officials. Community officials, design professionals, and contractors can use this information, along with the flood hazard information developed by FEMA and other agencies, to provide advice about retrofitting options.

#### 7.1.2 Structure Inspection

Structures being considered for floodproofing should be inspected to determine the construction method and type of foundation. Four characteristics of a building that are particularly important in retrofitting are: 1) construction type, 2) foundation type, 3) lowest floor elevation, and 4) condition. A key requirement of the inspection is performing a “Low Point of Entry” determination (see Figure 4-11).



**Figure 4-11. Example of a low point of entry survey**

### 7.1.3 Consultation with Local Officials

UDFCD and local officials have copies of the FIS and FIRM published for the community by FEMA. UDFCD or community officials can determine whether a building is in the regulatory floodplain and, if so, the FPE/BFE at the location of the building.

Local officials will provide federal, state, and local regulations, codes, and other requirements that determine what retrofitting methods will be allowed. Officials can also provide information about federal, state, and local programs that provide financial assistance for homeowner retrofitting projects. If the property is 50 or more years old and federal financial assistance is being received for a retrofitting project, then the State Historic Preservation Office should also be contacted.

### 7.1.4 Consultation with Design Professional

The owner of a structure that needs floodproofing will need to consult with a design professional and a contractor in order to choose the appropriate floodproofing method and ensure that the method is properly constructed. Table 4-7 shows the types of contractors and design professionals that may be required for each of the retrofitting methods.

## 7.2 Potential Sources of Financial Assistance at Federal, State, and Local Levels

FEMA and other federal agencies have a wide array of financial assistance programs that help states, communities, and individual property owners mitigate the negative effects of flood hazards. Property owners may be eligible to receive financial assistance for a retrofitting project through one or more of these programs. If a presidential declaration of a major disaster has been issued for the area, property owners should seek information from FEMA and the state and local government representatives supporting the post-disaster recovery of the community.

The community's floodplain management ordinance or law includes requirements concerning construction in the community's regulatory floodplain. These requirements apply not only to new buildings but also to existing buildings that have been substantially damaged or that are being substantially improved. If the structure falls into one of the latter two categories, one of the following will be required:

- Elevate the building so that its lowest floor is at or above the FPE (Elevation Method).
- Move the building out of the regulatory floodplain (Relocation Method).
- Wet-floodproof the part of the building that is below the FPE (Wet Floodproofing Method). (This alternative is allowed only if the part of the building that is below the FPE is used solely for parking, storage, and building access and is not a basement as defined by the NFIP).
- Communities with more restrictive floodplain management ordinances or laws may require a greater level of protection.

Although the substantial damage/substantial improvement requirement helps protect lives and property, it has at times placed an additional burden on property owners who were trying to repair their damaged buildings. Under the original terms and conditions of the NFIP Standard Flood Insurance Policy (SFIP), the owner of a substantially damaged building was reimbursed for the costs of repairing the damage but not for the costs of complying with state and local requirements concerning substantially damaged structures. For example, the homeowner would not have been reimbursed for the cost of elevating the building, even though state or local ordinances or laws required elevating.



**Table 4-7. Requirements for contractor and design professional services**

<b>Method</b>	<b>Need for Contractor and/or Design Professional</b>	<b>Primary Services</b>
Elevation	Design Professional	Evaluating the condition, stability, and strength of the existing foundation to determine whether it can support the increased load of the elevated building, including any wind and seismic loads.
	Contractor: Building Elevation Contractor	Disconnecting utilities, jacking up the building, increasing the height of the foundation, and connecting utilities.
Wet Floodproofing	Design Professional	Designing any necessary replacements of vulnerable structural materials and relocated utility systems.
	Contractor: General Construction Contractor	Replacing vulnerable structural and finishing materials below the FPE with flood-resistant materials, raising utilities and appliances to a location above the FPE, and installing openings required to allow the entry of floodwaters.
Relocation	Design Professional	Designing any new building, foundation, and site improvements that may be required, such as new utility systems.
	Contractor: Building Moving Contractor	Jacking up the building, moving it to the new site, and installing it on the new foundation.
	Contractor: General Construction Contractor	Preparing the new site (including grading, foundation construction, and utilities) and cleaning up the old site (including demolition).
Dry Floodproofing	Design Professional	For masonry walls to be dry floodproofed higher than 3 feet and for masonry veneer or frame walls to be dry floodproofed higher than 2 feet, evaluating the condition, stability, and strength of the existing walls to determine whether they can withstand the pressure from floodwaters at the FPE; designing or selecting flood shields for openings.
	Contractor: General Construction Contractor	Applying waterproof sealants and membranes, installing flood shields over openings below the FPE, installing backflow valves in sewer and water lines, and, if necessary, bracing or modifying walls so that they can withstand the pressure from floodwaters at the FPE.
Levees and Floodwalls	Design Professional	Assessing the adequacy of soils at the site and preparing the engineering design to ensure that the levee or floodwall, including any closures required, will be structurally stable under the expected flood loads and will be able to resist erosion, scour, and seepage.
	Contractor: General Construction Contractor	Constructing the levee or floodwall.
Demolition	Design Professional	Designing any new building, foundation, and site improvements that may be required, such as new utility systems.
	Contractor: Demolition Contractor	Disconnecting and capping utility lines, tearing down the damaged building, hauling away debris, and cleaning up the old site.
	Contractor: General Construction Contractor	Building the new building on the new site (May also be able to do all demolition work).

In 1997, to provide relief for the owners of houses substantially damaged by flooding, Congress authorized the inclusion of Increased Cost of Compliance (ICC) coverage in the SFIP. With this change in effect, the SFIP reimburses homeowners not only for the cost of repairing flood damage but also for the additional cost, up to a maximum amount stated in the SFIP, of meeting certain state and local floodplain management requirements concerning substantial damage and repetitive losses. Other sources of assistance include:

**Small Business Administration (SBA):** In areas declared a major disaster area by the President, the SBA provides low-interest disaster assistance loans to individuals for both businesses and private residences. These loans cover the cost of rebuilding a damaged building, including the cost of bringing the building into compliance with applicable ordinances and laws. The loans can pay for retrofitting of substantially damaged buildings required by ordinances or laws (including elevating flood-prone buildings and rebuilding badly damaged flood-prone buildings at an alternative location), as well as some mitigation projects that are not required by ordinances or laws. At the applicant's request, the amount of the loan may be increased by up to 20 percent for hazard mitigation measures not required by the community's ordinances or laws.

**Department of Housing and Urban Development (HUD):** In an area declared a major disaster area by the President, HUD may provide additional, or allow for the reprogramming of existing, community development block grants. If a community wishes, these grants may be used for retrofitting substantially damaged or substandard buildings (including elevating flood-prone buildings and acquiring badly damaged flood-prone buildings).

**U.S. Army Corps of Engineers (USACE):** The USACE has the statutory authority to participate in flood protection projects that may include residential retrofitting (including elevating flood-prone buildings and acquiring badly damaged flood-prone buildings).

**Natural Resources Conservation Service (NRCS):** The NRCS has the statutory authority to participate in small watershed flood protection projects that may include residential retrofitting.

## 8.0 Glossary

**A Zone:** See Zone A.

**Alluvial fan:** An area at the base of a valley where the slope flattens out, allowing the floodwater to decrease in speed and spread out, dropping sediment and rock over a fan-shaped area.

**Amendment:** A change to a FEMA floodplain map that removes an area that was inadvertently included in the Special Flood Hazard Area.

**Approximate studies:** Flood hazard mapping done using approximate study methods that show the approximate outline of the base floodplain. An approximate study does not produce a base flood elevation.

**B Zone:** See Zone B.

**Base flood depth:** A measurement of the base flood in feet above ground, used for shallow flooding.

**Base flood:** The flood having a 1% chance of being equaled or exceeded in any given year. Also referred as the 100-year flood. The base flood is used by the NFIP as the basis for mapping, insurance rating, and regulating new construction.

**Basement:** Any area of the building having its floor subgrade (below ground level) on all sides.

**Base floodplain:** The area of water and land inundated by the base flood.

**Basin:** See watershed.

**Bathymetry:** The measurement of depths of water in the ocean or lakes.

**Bench marks:** Monuments on the ground that show the elevation of the spot above sea level.

**Building:** A walled and roofed structure including a gas or liquid storage tank that is principally above ground as well as a manufactured home. This is equivalent to the term “structure” in the federal regulations (44 CFR 59.1).

**Building condition survey:** A windshield survey conducted to obtain a preliminary evaluation of the extent and severity of damage to buildings after a disaster.

**C Zone:** See Zone C.

**CAP:** Community Assistance Program.

**Catchment area:** See watershed.

**cfs:** Cubic feet per second, the unit by which discharges are measured (a cubic foot of water is about 7.5 gallons).

**CLOMA:** Conditional Letter of Map Amendment.

**CLOMR:** Conditional Letter of Map Revision.

**Closed basin lake:** A lake that has either no outlet or a relatively small one, where rainfall or groundwater can cause the lake's level to rise faster than it can drain.

**Community Assistance Program:** A FEMA program that funds state activities that help communities in the NFIP.

**Community Rating System:** A program that provides a flood insurance premium rate reduction based on a community's floodplain management activities.

**Community:** A city, county, township, Indian tribe or authorized tribal organization, Alaska Native village or authorized native organization, or other local government with the statutory authority to adopt and enforce floodplain regulations and participate in the National Flood Insurance Program.

**Conditional Letter of Map Amendment:** A statement from FEMA that if a project is constructed as planned, a Letter of Map Amendment can be issued later.

**Conditional Letter of Map Revision:** A statement from FEMA that if a project is constructed as planned, a Letter of Map Revision can be issued later.

**Contour map:** A topographic map that shows points with the same elevation as connected by a contour line.

**Contour:** A line of equal elevation on a topographic (contour) map.

**Conveyance shadow:** An area upstream or downstream of an existing obstruction to flood flows.

**Cross section:** Surveyed information that describes the stream and the floodplain at a particular point along the stream.

**CRS:** Community Rating System.

**Dam breach inundation area:** The area flooded by a dam failure.

**Damage Survey Report:** A form completed by disaster assistance staff to determine the repair and reconstruction needs of public and private nonprofit facilities.

**Datum:** A common vertical elevation reference point, usually in relation to sea level.

**Detailed studies:** Flood hazard mapping studies that are done using hydrologic and hydraulic methods that produce base flood elevations, floodways, and other pertinent flood data.

**Development:** Any man-made change to improved or unimproved real estate, including but not limited to buildings or other structures, mining, dredging, filling, grading, paving, excavation or drilling operations or storage of equipment and materials.

**DFIRM:** Digital Flood Insurance Rate Map. An official map of a community on which FEMA has delineated both the Special Flood Hazard Areas and the risk premium zones applicable to the community.

**Discharge:** The amount of water that passes a point in a given period of time. Rate of discharge is usually measured in cubic feet per second (cfs).

**DSR:** Damage survey report.

**Elevation reference marks:** See bench marks.

**Emergency Operations Center:** A facility that houses communications equipment that is used to coordinate the response to a disaster or emergency.

**Eminent domain:** Governmental power to acquire a property without the owner's consent.

**Encroachment review:** An analysis to determine if a project will increase flood heights or cause increased flooding downstream.

**EOC:** Emergency Operations Center.

**FBFM:** Flood Boundary Floodway Map. An official map of a community on which FEMA has delineated the regulatory floodway. Recent Flood Insurance Studies show the floodway on the FIRM and do not include an FBFM.

**FEMA:** Federal Emergency Management Agency.

**FHBM:** Flood Hazard Boundary Map. An official map of a community published by FEMA that delineates the approximate boundary of the floodplain. An FHBM is generally the initial map provided the community and is eventually superseded by a FIRM.

**FIA:** Federal Insurance Administration. FIA was the part of FEMA, which administered the National Flood Insurance Program. This is now the responsibility of FEMA's Mitigation Division.

**FIRM:** Flood Insurance Rate Map. An official map of a community on which FEMA has delineated both the Special Flood Hazard Areas and the risk premium zones applicable to the community.

**Flash flood:** A flood in hilly and mountainous areas that may come minutes after a heavy rain. One can also occur in urban areas where pavements and drainage improvements speed runoff to a stream.

**Flood:** A general and temporary condition of partial or complete inundation of normally dry land areas.

**Flood fringe:** The portion of the floodplain lying outside of the floodway.

**Flood hazard mitigation:** All actions that can be taken to reduce property damage and the threat to life and public health from flooding.

**Flood Insurance Study:** A report published by FEMA for a community issued along with the community's Flood Insurance Rate Map (FIRM). The study contains such background data as the base flood discharges and water surface elevations that were used to prepare the FIRM.

**Flood Mitigation Assistance:** A grant program that supports plans and projects for mitigating losses to insured buildings funded by the National Flood Insurance Program.

**Flood of record:** The highest known flood level for the area, as recorded in historical documents.

**Floodplain:** Any land area susceptible to being inundated by flood waters from any source.

**Floodproofing:** Protective measures added to or incorporated in a building that is not elevated above the base flood elevation to prevent or minimize flood damage. "Dry floodproofing" measures are designed to

keep water from entering a building. “Wet floodproofing” measures minimize damage to a structure and its contents from water that is allowed into a building.

**Floodway:** The channel of a river or other watercourse and that portion of the adjacent floodplain that must remain open to permit passage of the base flood without cumulatively increasing the water surface elevation more than a designated height (historically this was 1 foot, but it is now 0.5 foot in Colorado, per the CWCB Rules and Regulations for Regulatory Floodplains that became effective in 2011).

**FMA:** Flood Mitigation Assistance.

**Freeboard:** A margin of safety added to the base flood elevation to account for waves, debris, variability, and/or lack of data.

**Geographic information system:** Computer based map systems that allow the user to keep a map updated easily and to correlate geographic information with other data, such as tax records on properties.

**GIS:** Geographic Information System.

**Hazard Mitigation Grant Program:** A FEMA disaster-assistance grant that funds mitigation projects.

**HEC-2:** A computer model used to conduct a hydraulic study, which produces flood elevations, velocities and floodplain widths.

**HEC-RAS:** A computer model used to conduct a hydraulic study, which produces flood elevations, velocities and floodplain widths.

**Home rule:** A community authorized to do anything that is not prohibited by statute.

**Human intervention:** Actions that must be taken by one or more persons before floodwaters arrive in order for a building to be floodproofed.

**Hydrodynamic force:** The force of moving water, including the impact of debris and high velocities.

**Hydrologic cycle:** The natural cycle that circulates water throughout the environment to maintain an overall balance between water in the air, on the surface and in the ground.

**Hydrology:** The science dealing with the waters of the earth. A flood discharge is developed by a hydrologic study.

**Hydrostatic pressure:** The pressure put on a structure by the weight of standing water. The deeper the water, the more it weighs and the greater the hydrostatic pressure.

**Ice floe:** Large chunks of ice that can cause a great deal of damage when a frozen river or lake begins to melt and break up.

**Ice jam:** Flooding that occurs when warm weather and rain break up frozen rivers and the broken ice floats downriver until it is blocked by an obstruction, creating an ice dam that blocks the channel and causes flooding upstream.

**Increased Cost of Compliance:** An additional claim payment made to a flood insurance policy holder to help cover the cost of bringing a substantially damaged or repetitively damaged building into compliance with the community’s floodplain management ordinance.

**Individual and Family Grants:** A disaster assistance grant that helps people with their unmet needs (i.e., needs not helped by other disaster assistance programs).

**Inverse condemnation:** See “taking.”

**ISO:** The Insurance Services Office, Inc., an insurance organization that provides support to FEMA on implementation of the Community Rating System.

**Lateral pressure:** The amount of pressure imposed sideways by standing water. Deeper water exerts more lateral pressure than shallower water.

**Letter of Map Amendment (LOMA):** An official revision to a FEMA map done by describing the property affected. LOMAs are generally issued when properties have been inadvertently included in the floodplain.

**Letter of Map Change (LOMC):** A Letter of Map Amendment or a Letter of Map Revision.

**Letter of Map Revision (LOMR):** An official revision to a FEMA map done by describing the property affected.

**Limited Map Maintenance Project:** A small-scale restudy of a Flood Insurance Study.

**LOMA:** Letter of Map Amendment.

**LOMR:** Letter of Map Revision.

**Lowest Floor:** The lowest floor of the lowest enclosed area (including basement) of a building.

**Market value:** The price a willing buyer and seller agree upon.

**Meander:** A curve in a river.

**Mitigation Division:** The FEMA office that sets national policy for the NFIP and administers the mapping program.

**M-O-M:** Multi-objective management.

**Movable bed streams:** A type of flooding that features uncertain flow paths.

**Mudslide (i.e., mudflow):** A condition where there is a river, flow or inundation of liquid mud down a hillside.

**Mudflow:** See mudslide.

**Multi-objective management:** An approach to planning and funding local programs that involves a variety of local interests and concerns.

**NEPA:** The National Environmental Policy Act, a federal law that requires agencies to evaluate the environmental impact of a proposed project.

**NGVD:** National Geodetic Vertical Datum of 1929, the national datum used by the National Flood Insurance Program. NGVD is based on mean sea level. It was known formerly as the “Mean Sea Level Datum of 1929 (MSL).”

**No-rise Certification:** A certification by an engineer that a project will not cause a set increase in flood heights.

**Non-structural flood protection measures:** Administrative tools for controlling flooding and flood damage, including regulations on development, building codes, property acquisition and structure relocation, and modification of existing buildings.

**Ordinance:** The generic term for a law passed by a local government.

**Overbank flooding:** Flooding that occurs when downstream channels receive more rain or snowmelt from their watershed than normal, or a channel is blocked by an ice jam or debris. Excess water overloads the channels and flows out onto the floodplain.

**Planned unit development (PUD):** A regulatory approach that allows a developer to design the entire area while individual requirements may be relaxed to allow for open space, mixed land uses, and other variances to traditional zoning rules.

**Post-FIRM building:** For insurance rating purposes, a post-FIRM building was constructed or substantially improved after December 31, 1974, or after the effective date of the initial Flood Insurance Rate Map of a community, whichever is later. For a community that participated in the NFIP when its initial FIRM was issued, post-FIRM buildings are the same as new construction and must meet the National Flood Insurance Program's minimum floodplain management standards.

**Pre-FIRM building:** For insurance rating purposes, a pre-FIRM building was constructed or substantially improved on or before December 31, 1974, or before the effective date of the initial Flood Insurance Rate Map of the community, whichever is later. Most pre-FIRM buildings were constructed without taking the flood hazard into account.

**Probability:** A statistical term having to do with the size of a flood and the odds of that size of flood occurring in any year.

**Profile:** A graph that shows elevations of various flood events.

**Public/Infrastructure Assistance:** A disaster assistance grant that helps public agencies and nonprofit organizations finance repairs and reconstruction of public infrastructure.

**Q3 Flood Data Product:** A graphical representation of certain features of a FIRM in digital format.

**Reconstruction:** Building a new structure on the old foundation or slab of a structure that was destroyed, damaged, purposefully demolished or razed. The term also applies when an existing structure is moved to a new site.

**Regular Program:** Also called the Regular Phase. The phase of community participation in the National Flood Insurance Program that begins on the date of the Flood Insurance Rate Map or when the community adopts an ordinance that meets the minimum requirements of the NFIP and adopts the technical data provided with the FIRM, whichever is later. Nearly all communities participating in the NFIP are in the Regular Program.

**Rehabilitation:** An improvement made to an existing structure which does not affect its external dimensions.

**Restudy:** A new Flood Insurance Study for all or part of a community that has already had a Flood



Insurance Study.

**Retrofitting:** Retrofitting techniques include floodproofing, elevation, construction of small levees, and other modifications made to an existing building or its yard to protect it from flood damage.

**Revision:** A change to a floodplain map based on new data submitted to FEMA.

**Riverine:** Of or produced by a river. Riverine floodplains have readily identifiable channels. Floodway maps can only be prepared for riverine floodplains.

**Roughness:** A measure related to ground surface conditions that reflects changes in floodwater velocity due to ground friction.

**Runoff:** Rainfall and snowmelt that reaches a stream.

**SFHA:** Special Flood Hazard Area.

**Sheet flow:** Floodwater that spreads out over a large area that does not have defined channels at a somewhat uniform depth.

**Special Flood Hazard Area:** The base floodplain displayed on FEMA maps. It includes the A and V Zones.

**Stafford Act:** The Robert T. Stafford Disaster Relief and Emergency Assistance Act of 1988, as amended, which authorizes FEMA's current disaster assistance programs and the Hazard Mitigation Grant Program. The Disaster Mitigation Act of 2000 made extensive changes to the Stafford Act.

**Stationing:** Determining the distance along a stream.

**Statutory authority:** The powers granted to a local government by state law.

**Stillwater flood elevations:** Show the elevations of various coastal floods, not counting waves.

**Storm surge:** Water that is pushed toward shore by persistent high wind and changes in air pressure. Storm surges can result from hurricanes and other coastal storms.

**Stormwater management:** Efforts to reduce the impact of increased runoff that results from new development.

**Stormwater detention:** Storing stormwater runoff for release at a restricted rate after the storm subsides.

**Stormwater retention:** Storing stormwater runoff for later use in irrigation or groundwater recharge, or to reduce pollution.

**Structural flood control:** Measures that control floodwaters by construction of barriers or storage areas or by modifying or redirecting channels.

**Submit to rate:** A process used when an insurance agent cannot complete the rate calculation for a flood insurance policy. The application is sent to the WYO Company or FEMA to be individually rated.

**Substantial damage:** Damage of any origin sustained by a structure whereby the cost of restoring the structure to its before damaged condition would equal or exceed 50 percent of the market value of the

structure before the damage occurred.

**Substantial improvement:** Any reconstruction, rehabilitation, addition or other improvement to a structure, the total cost of which equals or exceeds 50 percent of the market value of the structure before the start of construction of the improvement. The definition of “substantial improvement” includes buildings that have incurred “substantial damage” regardless of the actual repair work performed.

**Taking:** Obtaining private property with or without compensating the owner. The term also includes reducing the value of private property to such an extent that the owner is deprived of all economic interest.

**Thalweg:** The bottom of a river channel.

**Topographic map:** See contour map.

**Transect:** A survey of topographic conditions used in coastal flood studies.

**Tsunami:** A large wave caused by an underwater earthquake or volcano which can raise water levels as much as 15 feet.

**V Zone:** See “Zone V.”

**Variance:** A grant of relief by a community from the terms of a land use, zoning, or building code regulation.

**Velocity:** The speed of moving water; a force that is measured in feet per second.

**Watershed:** An area that drains into a lake, stream, or other body of water.

**X Zone:** See “Zone X.”

**Zone A:** The Special Flood Hazard Area (except coastal V Zones) shown on a community’s Flood Insurance Rate Map. There are five types of A Zones:

**A:** SFHA where no base flood elevation is provided.

**A1-30:** Numbered A Zones (e.g., A7 or A14), SFHA where the FIRM shows a base flood elevation in relation to NGVD.

**AE:** SFHA where base flood elevations are provided. AE Zone delineations are now used on new FIRMs instead of Numbered A Zones.

**AO:** SFHA with sheet flow, ponding, or shallow flooding. Base flood depths (feet above grade) are provided.

**AH:** Shallow flooding SFHA. Base flood elevations in relation to NGVD are provided.

**Zone B:** Area of moderate flood hazard, usually depicted on Flood Insurance Rate Maps as between the limits of the base and 500-year floods. B Zones are also used to designate base floodplains of little hazard, such as those with average depths of less than 1 foot.

**Zone C:** Area of minimal flood hazard, usually depicted on Flood Insurance Rate Maps as above the

500-year flood level. B and C Zones may have flooding that does not meet the criteria to be mapped as a Special Flood Hazard Area, especially ponding and local drainage problems.

**Zone D:** Area of undetermined but possible flood hazard.

**Zone V:** The Special Flood Hazard Area subject to coastal high hazard flooding. There are three types of V Zones: V, V1-30, and VE, and they correspond to the A Zone designations.

**Zone X:** Newer Flood Insurance Rate Maps show Zones B and C (see above) as Zone X.

## 9.0 References

- Association of State Floodplain Managers (ASFPM), 2008. CFM Refresher Course Student Manual. December 29, 2008.
- Brown, J. and Crummy, K. (2013, December 29). State hurries to update maps; many damaged homes not in floodplain. *Denver Post*. Retrieved from [http://www.denverpost.com/news/ci\\_24809765/state-update-maps-many-damaged-homes-not-floodplain](http://www.denverpost.com/news/ci_24809765/state-update-maps-many-damaged-homes-not-floodplain) on January 14, 2014.
- Colorado Department of Natural Resources. 2010. Rules and Regulations for Regulatory Floodplains in Colorado. Colorado Water Conservation Board. Department of Natural Resources. Adopted November 10, 2010.
- Federal Emergency Management Agency. 1984. *Elevated Residential Structures*, FEMA 54. Washington, DC: FEMA.
- Federal Emergency Management Agency. 1986a. *Coastal Construction Manual*, FEMA 55. Washington, DC: FEMA.
- Federal Emergency Management Agency. 1986b. *Floodproofing Non-Residential Structures*, FEMA 102. Washington, DC: FEMA.
- Federal Emergency Management Agency. 1991. Answers to Questions About Substantially Damaged Buildings. FEMA 213. Washington, DC: FEMA.
- Federal Emergency Management Agency. 1993a. *Below-Grade Parking Requirements*. FIA-TB-6. Washington, DC: FEMA.
- Federal Emergency Management Agency. 1993b. *Flood-Resistant Material Requirements*. FIA-TB-2. Washington, DC: FEMA.
- Federal Emergency Management Agency. 1993c. *Non-Residential Floodproofing-Requirements and Certification*. FIA-TB-3. Washington, DC: FEMA.
- Federal Emergency Management Agency (FEMA). 1993d. *Openings in Foundation Walls*. FIA-TB-1. Washington, DC: FEMA.
- Federal Emergency Management Agency (FEMA). 1993e. *Wet Floodproofing Requirements*. FIA-TB-7. Washington, DC: FEMA.
- Federal Emergency Management Agency. 1994. Mitigation of Flood and Erosion Damage to Residential Buildings in Coastal Areas. FEMA 257. Washington, DC: FEMA.
- Federal Emergency Management Agency. 1995. Engineering Principles and Practices for Retrofitting Flood Prone Residential Buildings. FEMA 259. Washington, DC: FEMA.
- Federal Emergency Management Agency. 1996. Protecting Your Home from Flood Damage, Mitigation Ideas for Reducing Flood Loss. 2<sup>nd</sup> Edition. Washington, DC: FEMA.
- Federal Emergency Management Agency. 2000. *Above the Flood: Elevating Your Floodprone House*. Washington, DC: FEMA.

- Federal Emergency Management Agency. 2001. *Ensuring That Structures Built on Fill In or Near Special Flood Hazard Areas are Reasonably Safe from Flooding*. Washington, DC: FEMA.
- Federal Emergency Management Agency. 2001. *Engineering Principles and Practices for Retrofitting Flood-Prone Residential Structures*. Second Edition. Washington, DC: FEMA.
- Federal Emergency Management Agency. 2001. *Ensuring That Structures Built on Fill In or Near Special Flood Hazard Areas are Reasonably Safe from Flooding*. Washington, DC: FEMA.
- Federal Emergency Management Agency. 2001. *Nonstructural Flood Damage Reduction within the Corps of Engineers*. Washington, DC: USACE.
- Federal Emergency Management Agency. 2008. *Reducing Flood Losses Through the International Codes*. Third Edition. Washington, DC: FEMA.
- Federal Emergency Management Agency. 2009a. *Homeowner's Guide to Retrofitting: Six Ways to Protect Your Home from Flooding*. Washington, DC: FEMA.
- Federal Emergency Management Agency. 2009b. *Protecting Manufactured Homes from Floods and Other Hazards, A MultiHazard Foundation and Installation Guide. FEMA P-85, Second Edition*. Washington, DC:FEMA.
- Federal Emergency Management Agency. 2010. *National Flood Insurance Program (NFIP) Floodplain Management Requirements: A Study Guide and Desk Reference for Local Officials*. Washington, DC: FEMA.
- Federal Emergency Management Agency. 2011. *NFIP: Answers to Questions About the NFIP*. Washington D.C.: FEMA
- U.S. Army Corps of Engineers. 1984. *Floodproofing Systems and Techniques*. Washington, DC: USACE.
- U.S. Army Corps of Engineers. 1988. *Floodproofing Tests, Tests of Materials and Systems for Floodproofing Structures*. Vicksburg, MS: USACE.
- U.S. Army Corps of Engineers. 1990. *Raising and Moving a Slab-on-Grade House*. Washington, DC: USACE.
- U.S. Army Corps of Engineers. 1993. *Floodproofing—How to Evaluate Your Options*. Washington, DC: USACE.
- U.S. Army Corps of Engineers. 1994. *Local Floodproofing Programs*. Washington, DC: USACE
- U.S. Army Corps of Engineers. 1995a. *A Floodproofing Success Story Along Dry Creek at Goodlettsville, Tennessee*. Nashville, TN: USACE.
- U.S. Army Corps of Engineers. 1995b. *Floodproofing Regulations*, EP 1165-2-314. Washington, DC: USACE.
- U.S. Army Corps of Engineers. 1996. *Floodproofing Techniques, Programs, and References*. Washington, DC: USACE.
- U.S. Army Corps of Engineers. 1998. *Floodproofing Performance, Successes & Failures*. Washington, DC: USACE.

U.S. Army Corps of Engineers. 2010. *Final FRM Frequently Asked Questions Version 9-13-2010*. Washington, DC: USACE.

Urban Drainage and Flood Control District. 2010. *Sustainability on a Large Scale*. Denver, CO. April.



# Chapter 5

## Rainfall

### Contents

- 1.0 Overview ..... 1**
- 2.0 Rainfall Depth-Duration-Frequency ..... 2**
  - 2.1 Rainfall Depth-Duration-Frequency Maps..... 2
  - 2.2 Rainfall Depths for Durations Between 1- and 6-Hours ..... 2
- 3.0 Design Storm Distribution for CUHP ..... 2**
  - 3.1 Temporal Distribution..... 4
  - 3.2 Depth Reduction Factor (DRF) Adjustments ..... 6
- 4.0 Intensity-Duration Curves for Rational Method..... 9**
- 5.0 UD-Rain Excel Workbook..... 9**
- 6.0 Examples ..... 24**
  - 6.1 Example Computation of Point Rainfall ..... 24
  - 6.2 Example preparation of intensity-duration-frequency curve..... 25
  - 6.3 Example preparation of intensity-duration-frequency table and rainfall distribution using UD-rainfall. 27
- 7.0 References ..... 28**

### Tables

- Table 5-1. Storm duration and area adjustment for CUHP modeling..... 3
- Table 5-2. Design storm distributions of 1-hour NOAA Atlas 2, Volume III depths ..... 5
- Table 5-3. DRFs for design rainfall distributions 2-, 5-, and 10-year design rainfall ..... 7
- Table 5-4. DRFs for design rainfall distributions 25-, 50-, 100-, and 500-year design rainfall ..... 8

### Figures

- Figure 5-1. Rainfall depth-duration-frequency: 2-year, 1-hour rainfall ..... 10
- Figure 5-2. Rainfall depth-duration-frequency: 5-year, 1-hour rainfall ..... 11
- Figure 5-3. Rainfall depth-duration-frequency: 10-year, 1-hour rainfall ..... 12
- Figure 5-4. Rainfall depth-duration-frequency: 25-Year, 1-hour rainfall..... 13
- Figure 5-5. Rainfall depth-duration-frequency: 50-year, 1-hour rainfall ..... 14
- Figure 5-6. Rainfall depth-duration-frequency: 100-year, 1-hour rainfall ..... 15
- Figure 5-7. Rainfall depth-duration-frequency: 2-year, 6-hour rainfall ..... 16
- Figure 5-8. Rainfall depth-duration-frequency: 5-year, 6-hour rainfall ..... 17
- Figure 5-9. Rainfall depth-duration-frequency: 10-year, 6-hour rainfall ..... 18
- Figure 5-10. Rainfall depth-duration-frequency: 25-year, 6-hour rainfall ..... 19
- Figure 5-11. Rainfall depth-duration-frequency: 50-year, 6-hour rainfall ..... 20
- Figure 5-12. Rainfall depth-duration-frequency: 100-year, 6-hour rainfall ..... 21
- Figure 5-13. Depth reduction factor (DRF) curves for infrequent storm events ..... 22
- Figure 5-14. Depth reduction factor (DRF) curves for minor storm events (2-, 5-, and 10-year events).. 23





## 1.0 Overview

The purpose of this chapter is to provide rainfall depth, duration, intensity, and frequency data and analytical methods used to develop the rainfall information needed to carry out the hydrological analyses described in the *Runoff* chapter of the Urban Storm Drainage Criteria Manual (USDCM). Specifically, this chapter describes:

- The basis of point precipitation values for locations within the Urban Drainage and Flood Control District (UDFCD),
- Temporal distributions of point rainfall to develop the hyetographs necessary for the Colorado Urban Hydrograph Procedure (CUHP) hydrological modeling, and
- Intensity-duration-frequency (IDF) data and relationships used in Rational Method hydrologic computations.

This chapter includes analysis of the 2-, 5-, 10-, 25-, 50-, and 100-year return storm events. If information is needed regarding other storm return periods or for areas in Colorado but outside UDFCD, the reader is directed to the Precipitation-Frequency Atlas of the Western United States, Volume III-Colorado (NOAA Atlas 2) published by the National Oceanic and Atmospheric Administration (NOAA) in 1973, which contains a more complete description of rainfall analysis in the State of Colorado. A 1-hour point precipitation estimate for the 500-year event for a given location can be obtained using linear regression of the logarithm of recurrence interval versus 1-hour point depths for the 2- through 100-year storm events.

### History of the Rainfall Chapter

The USDCM that was originally published in 1969 contained rainfall depth-duration-frequency maps for the 2-, 10-, and 100-year events and guidelines for developing design rainstorms and I-D-F curves for any location within UDFCD. The NOAA Atlas 2, Volume III, published in 1973, was based on a longer period of record and a large number of gages. Unfortunately the maps in the USDCM and the NOAA Atlas did not agree.

Since 1977 UDFCD has studied the rainfall and runoff relationships in the Denver metropolitan area, including analysis of the (then) 73-year period at the Denver rain gage. This analysis indicated that the NOAA Atlas 2 maps, although not perfect, were more in line with the rainfall frequency distribution of the long-term record than the maps in the original USDCM.

As the 1982 version of CUHP was being developed, UDFCD developed methods to convert the information in the NOAA Atlas 2 into a family of design rainstorms by distributing these design storms in a manner that yielded peak runoff recurrence frequency distributions consistent with observed rainfall-runoff characteristics in the Denver metropolitan area. For the above-stated reasons and to use rainfall information consistent with the information being used by the State of Colorado, it was concluded that the NOAA Atlas 2 rainfall information should also be used within UDFCD.

In 2013, the new *NOAA Atlas 14 Precipitation-Frequency Atlas of the United States, Volume 8-Midwestern States* was published with new precipitation values. UDFCD provided peer review of NOAA's work. After thorough review, UDFCD determined that changing the precipitation values was not warranted and decided not to adopt the new values. For more information see *UDFCD Position on the NOAA Atlas 14 Precipitation-Frequency Atlas, Volume 8*, dated September 11, 2013 and available at [www.udfcd.org](http://www.udfcd.org).

## 2.0 Rainfall Depth-Duration-Frequency

To apply CUHP or the Rational Method as outlined in the *Runoff* Chapter, 1-hour point rainfall data for the area of interest are needed. To apply CUHP to watersheds larger than 15-square miles in size, 3-hour and 6-hour point rainfall depths are also required.

### 2.1 Rainfall Depth-Duration-Frequency Maps

UDFCD used the data provided in the NOAA Atlas 2, Volume III to develop rainfall depth-duration-frequency maps for the Denver Region. Figures 5-1 through 5-12 provide maps for the 1-hour and 6-hour durations for the 2-, 5-, 10-, 25-, 50-, and 100-year recurrence frequencies.

### 2.2 Rainfall Depths for Durations Between 1- and 6-Hours

The 2-hour point rainfall depth can be determined using Equation 5-1, which was derived from nomographs in the NOAA Atlas 2, Volume III:

$$P_2 = P_1 + 0.342(P_6 - P_1) \quad \text{Equation 5-1}$$

Similarly, point rainfall depths for the 3-hour storm can be determined using Equation 5-2:

$$P_3 = P_1 + 0.597(P_6 - P_1) \quad \text{Equation 5-2}$$

Where:

$P_1$  = 1-hour point rainfall (inches)

$P_2$  = 2-hour point rainfall (inches)

$P_3$  = 3-hour point rainfall (inches)

$P_6$  = 6-hour point rainfall (inches)

See Section 6.1 for an example of the calculation of point rainfall depths.

## 3.0 Design Storm Distribution for CUHP

The 1-hour point precipitation values from Figures 5-1 through 5-6 are distributed into 5-minute increments (see Table 5-2) to develop temporal distributions for use with CUHP. The rainfall duration used with CUHP varies with the size of the watershed being analyzed as shown in Table 5-1. For larger storms, Depth Reduction Factors (DRFs)<sup>1</sup> are applied to the incremental precipitation depths to take into account averaging effects for larger watershed sizes. For the 2-, 5-, and 10-year events (minor events), DRFs can be applied to watersheds 2-square miles or larger. For the 25-, 50-, 100-, and 500-year events, DRFs are applicable to watersheds 15-square miles and larger. Table 5-1 provides design storm durations and applicability of DRFs based on watershed area.

---

<sup>1</sup> The term Depth Reduction Factor (DRF) is used in this text but is interchangeable with the terms Depth Area Reduction Factor (DARF) and Area Reduction Factor (ARF) used by others.

**Table 5-1. Storm duration and area adjustment for CUHP modeling**

Design Storm	Watershed Area (square miles)	Recommended Storm Duration	Apply DRF?
2-, 5-, and 10-Year	$A \leq 2.0$	2 hours	No
	$2.0 < A < 15.0$	2 hours	Yes – Use Table 5-3
	$A \geq 15.0$	6 hours	Yes – Use Table 5-3
25-, 50-, 100-, and 500-Year	$A < 15.0$	2 hours	No
	$A \geq 15.0$	6 hours	Yes – Use Table 5-4

### Basis for Design Storm Distribution

The orographic effects of the Rocky Mountains and the high plains near the mountains as well as the semi-arid climate influence rainfall patterns in the Denver area. Rainstorms often have an “upslope” character where the easterly flow of moisture settles against the mountains. These types of rainstorms have durations that can exceed six hours and, although they may produce large amounts of total precipitation, they are rarely intense. Although upslope storms may cause local drainage problems or affect the flood levels of large watersheds, typically they are not the cause of 2- through 100-year type of flooding of small urban catchments in the Denver area.

Very intense rainfall in the Denver area typically results from convective storms or frontal stimulated convective storms. The most intense periods of rainfall for these types of storms often occur in periods that are less than one or two hours. These storms can produce brief periods of very high rainfall intensities. These short-duration, high-intensity rainstorms cause most of the flooding problems in the great majority of urban catchments.

Analysis of a 73-year record of rainfall at the Denver rain gage revealed that an overwhelming majority of the intense rainstorms produced their greatest intensities in the first hour of the storm. In fact, of the 73 most intense storms analyzed, 68 had the most intense period begin and end within the first hour of the storm, and 52 had the most intense period begin and end within the first half hour of the storm. These types of storms have been categorized as “leading intensity” storm events. The data clearly show that the “leading intensity” storms predominate among the “non-upslope” type storms in the Denver region.

The recommended design storm distribution takes into account the observed “leading intensity” nature of the convective storms. In addition, the temporal distributions for the recommended design storms were designed to be used with the 1982 and later version of CUHP, the published NOAA 1-hour precipitation values (NOAA 1973) and Horton’s infiltration loss equation. They were developed to approximate the recurrence frequency of peak flows and runoff volumes (i.e., 2- through 100-years) that were found to exist for the watersheds for which rainfall-runoff data were collected. The procedure for the development of these design storm distributions and the preliminary results were reported in literature and UDFCD publications (Urbonas 1978; Urbonas 1979).

### 3.1 Temporal Distribution

The current version of CUHP was designed to be used with the NOAA Atlas 2, Volume III 1-hour rainfall depths provided in Figures 5-1 through 5-6. To obtain a temporal distribution for a design storm, the 1-hour depth is converted into a 2-hour design storm by multiplying the 1-hour depth(s) by the percentages for each time increment given in Table 5-2. This conversion is handled automatically in CUHP for the 1-hour depth specified in the CUHP input file.

The temporal distribution presented in Table 5-2 represents a design storm for use with a distributed rainfall-runoff routing model. The distribution is the result of a calibration process performed by UDFCD to provide, in conjunction with the use of CUHP, peak runoff rates and runoff volumes of the same return period as the design storm (Urbonas 1978). The NOAA Atlas 2, Volume III values are “embedded” in the 2-hour and other duration design storms. The first hour of the rainfall distribution includes the most intense rainfall (25% of the 1-hour point rainfall depth is assumed to occur over a 5-minute period). The 2-hour precipitation total is approximately 116% of the 1-hour rainfall depth for all recurrence intervals included in this chapter, as shown in the totals at the bottom of Table 5-2. It should be noted that the 2-hour point rainfall depth calculated in Equation 5-1 may differ slightly from the summation of the incremental depths from the 2-hour distribution depending on the relative location within the UDFCD Boundary.

To develop the temporal distribution for the 6-hour design storm (watersheds greater than 15.0 square miles), first prepare a 3-hour design storm. Developing the 3-hour storm is an intermediate step in deriving the 6-hour temporal distribution. To develop the temporal distribution for the 3-hour design storm, first prepare the 2-hour design storm distribution using the 1-hour storm point precipitation and the temporal percentage distribution shown in Table 5-2. The 2-hour distribution provides the first two hours of the 3-hour design storm. The difference between the 3-hour point precipitation (Equation 5-2) and the 2-hour point precipitation (Equation 5-1) is then distributed evenly over the third hour of the storm (i.e., the period of 125 minutes to 180 minutes).

The 3-hour distribution provides the first three hours of the 6-hour design storm. The difference between the 6-hour point precipitation (from Figures 5-7 through 5-12) and the 3-hour point precipitation (calculated by summation of the incremental depths from the 3-hour distribution) is distributed evenly over the period of 185 minutes to 360 minutes (i.e. the last three hours of the 6-hour design storm).

**Table 5-2. Design storm distributions of 1-hour NOAA Atlas 2, Volume III depths**

Time Minutes	Percent of 1-Hour NOAA Atlas 2, Volume III Rainfall Atlas Depth (%)				
	2-Year	5-Year	10-Year	25- and 50-Year	100- and 500-Year
5	2.0	2.0	2.0	1.3	1.0
10	4.0	3.7	3.7	3.5	3.0
15	8.4	8.7	8.2	5.0	4.6
20	16.0	15.3	15.0	8.0	8.0
25	25.0	25.0	25.0	15.0	14.0
30	14.0	13.0	12.0	25.0	25.0
35	6.3	5.8	5.6	12.0	14.0
40	5.0	4.4	4.3	8.0	8.0
45	3.0	3.6	3.8	5.0	6.2
50	3.0	3.6	3.2	5.0	5.0
55	3.0	3.0	3.2	3.2	4.0
60	3.0	3.0	3.2	3.2	4.0
65	3.0	3.0	3.2	3.2	4.0
70	2.0	3.0	3.2	2.4	2.0
75	2.0	2.5	3.2	2.4	2.0
80	2.0	2.2	2.5	1.8	1.2
85	2.0	2.2	1.9	1.8	1.2
90	2.0	2.2	1.9	1.4	1.2
95	2.0	2.2	1.9	1.4	1.2
100	2.0	1.5	1.9	1.4	1.2
105	2.0	1.5	1.9	1.4	1.2
110	2.0	1.5	1.9	1.4	1.2
115	1.0	1.5	1.7	1.4	1.2
120	1.0	1.3	1.3	1.4	1.2
Totals	115.7%	115.7%	115.7%	115.6%	115.6%

### 3.2 Depth Reduction Factor (DRF) Adjustments

A Depth Reduction Factor (DRF) adjustment can be used when applying a point precipitation value to an entire watershed area for a given recurrence interval. Since average rainfall over a large watershed is generally lower than point rainfall, a DRF is applied to reduce point precipitation values to area-average precipitation values. The NOAA Atlas 2, Volume III provides guidelines for adjusting the rainfall depths with increasing catchment area. Area-depth adjustments are given in the Atlas for durations of ½-, 1-, 3-, 6- and 24-hours. Figure 5-13 is based on the NOAA Atlas 2, Volume III. The 15-minute curve was extrapolated by UDFCD from the information shown for other storm durations on Figure 5-13. The fast response times of urbanized watersheds and sharp rainstorm distribution gradients in the Denver area require adjustments of rainfall depths for storm durations that are less than ½-hour. Figure 5-13 provides DRF curves that can be applied to the 25-, 50-, 100- and 500-year events (NOAA 1973).

For more-frequently occurring storm events, including the 2- through 10-year events, UDFCD analyzed results from a 2010 study conducted by Carlton Engineering, Inc. on behalf of the City of Colorado Springs *Fountain Creek Rainfall Characterization Study* (Carlton 2010). The Carlton study developed cell-centered DRFs<sup>2</sup> based on extensive analysis of radar data in the Fountain Creek watershed. UDFCD analyzed the data provided in this report to develop geographically-fixed DRF estimates for the 2- through 10-year events, by averaging recommended DRFs from the Carlton report and the NOAA Atlas 2, Volume III. Figure 5-14 provides these curves.

The DRF adjustment factors are provided in Table 5-3 (2-, 5-, and 10-year design storms) and Table 5-4 (25-, 50-, 100, and 500-year design storms) to assist with DRF calculations.

---

<sup>2</sup> DRFs are commonly classified as “cell-centered” or “geographically-fixed” depending on how the factors were developed. Cell-centered DRFs are determined by analyzing gridded storm-cell data to determine the ratio of the average depth of rainfall produced by the overall storm cell (average of all grid point depths) to the maximum point rainfall depth (maximum grid point depth). A geographically-fixed DRF represents the ratio of average precipitation of a geographic area (watershed) to the maximum point rainfall depth occurring in the watershed. The difference between the two is the point of reference. For a cell-centered DRF, the point of reference is the storm cell itself, which may pass over many watersheds along the storm track. For a geographically-fixed DRF, the point of reference is the watershed, which receives precipitation as a storm cell passes over the watershed.

**Table 5-3. DRFs for design rainfall distributions 2-, 5-, and 10-year design rainfall**

Time (minutes)	Correction Factor by Watershed Area in Square Miles <sup>1</sup>								
	2	5	10	15	20	30	40	50	75
5	1.00	1.00	1.00	1.00	1.00	1.00	1.00	1.00	1.00
10	1.00	1.00	1.00	1.00	1.00	1.00	1.00	1.00	1.00
15	1.00	0.97	0.94	0.91	0.90	0.85	0.75	0.65	0.56
20	1.00	0.86	0.75	0.68	0.61	0.55	0.48	0.42	0.35
25	1.00	0.86	0.75	0.68	0.61	0.55	0.48	0.42	0.35
30	1.00	0.86	0.75	0.68	0.61	0.55	0.48	0.42	0.42
35	1.00	0.97	0.94	0.91	0.90	0.90	0.90	0.90	0.89
40	1.00	0.97	0.94	0.91	0.90	0.90	0.90	0.90	0.89
45	1.00	1.00	1.00	1.02	1.02	1.01	1.01	1.01	1.00
50	1.00	1.00	1.00	1.02	1.02	1.01	1.01	1.01	1.00
55	1.00	1.00	1.00	1.02	1.02	1.01	1.01	1.01	1.00
60	1.00	1.00	1.00	1.02	1.02	1.01	1.01	1.01	1.00
65	1.00	1.00	1.00	1.02	1.02	1.01	1.01	1.01	1.00
70	1.00	1.00	1.00	1.02	1.02	1.01	1.01	1.01	1.00
75	1.00	1.00	1.00	1.02	1.02	1.01	1.01	1.01	1.00
80	1.00	1.00	1.00	1.02	1.02	1.01	1.01	1.01	1.00
85	1.00	1.00	1.00	1.02	1.02	1.01	1.01	1.01	1.00
90	1.00	1.00	1.00	1.02	1.02	1.01	1.01	1.01	1.00
95	1.00	1.00	1.00	1.02	1.02	1.01	1.01	1.01	1.00
100	1.00	1.00	1.00	1.02	1.02	1.01	1.01	1.01	1.00
105	1.00	1.00	1.00	1.02	1.02	1.01	1.01	1.01	1.00
110	1.00	1.00	1.00	1.02	1.02	1.01	1.01	1.01	1.00
115	1.00	1.00	1.00	1.02	1.02	1.01	1.01	1.01	1.00
120	1.00	1.00	1.00	1.02	1.02	1.01	1.01	1.01	1.00
125-180	N/A	N/A	N/A	1.00	1.00	1.00	1.00	1.00	1.00
185-360	N/A	N/A	N/A	1.23	1.28	1.30	1.32	1.33	1.33

<sup>1</sup>For areas between the values listed in the table, correction factors can be obtained through linear interpolation between columns.



**Table 5-4. DRFs for design rainfall distributions 25-, 50-, 100-, and 500-year design rainfall**

Time (minutes)	Correction Factor by Watershed Area in Square Miles <sup>1</sup>					
	15	20	30	40	50	75
5	1.15	1.15	1.15	1.15	1.15	1.10
10	1.15	1.15	1.15	1.15	1.15	1.10
15	1.15	1.15	1.15	1.15	1.15	1.10
20	1.25	1.18	1.10	1.05	1.00	0.90
25	0.73	0.69	0.64	0.60	0.58	0.55
30	0.73	0.69	0.64	0.60	0.58	0.55
35	0.73	0.69	0.64	0.60	0.58	0.55
40	1.05	1.02	0.95	0.90	0.85	0.80
45	1.20	1.20	1.20	1.15	1.05	0.95
50	1.15	1.15	1.15	1.15	1.05	0.95
55	1.15	1.15	1.15	1.15	1.15	1.15
60	1.15	1.15	1.15	1.15	1.15	1.15
65	1.08	1.10	1.13	1.15	1.15	1.15
70	1.08	1.10	1.13	1.15	1.15	1.15
75	1.08	1.10	1.13	1.15	1.15	1.15
80	1.08	1.10	1.13	1.15	1.15	1.15
85	1.08	1.10	1.13	1.15	1.15	1.15
90	1.08	1.10	1.13	1.15	1.15	1.15
95	1.08	1.10	1.13	1.15	1.15	1.15
100	1.08	1.10	1.13	1.15	1.15	1.15
105	1.08	1.10	1.13	1.15	1.15	1.15
110	1.08	1.10	1.13	1.15	1.15	1.15
115	1.08	1.10	1.13	1.15	1.15	1.15
120	1.08	1.10	1.13	1.15	1.15	1.15
125-180	1.08	1.10	1.13	1.15	1.25	1.25
185-360	1.05	1.10	1.10	1.10	1.10	1.13

<sup>1</sup>For areas between the values listed in the table, correction factors can be obtained through linear interpolation between columns.

## 4.0 Intensity-Duration Curves for Rational Method

To develop depth-duration curves or intensity-duration curves for the Rational Method of runoff analysis take the 1-hour depth(s) obtained from Figures 5-1 through 5-6 and apply Equation 5-3 for the duration (or durations) of interest:

$$I = \frac{28.5 P_1}{(10 + T_d)^{0.786}} \quad \text{Equation 5-3}$$

Where:

$I$  = rainfall intensity (inches per hour)

$P_1$  = 1-hour point rainfall depth (inches)

$T_d$  = storm duration (minutes)

Equation 5-3 can also be expressed in terms of depth as shown in Equation 5-4 for calculating rainfall depths at durations less than one hour:

$$D = \frac{28.5 P_1 \cdot (T_d / 60)}{(10 + T_d)^{0.786}} \quad \text{Equation 5-4}$$

Where:

$D$  = rainfall depth (inches)

$P_1$  = 1-hour point rainfall depth (inches)

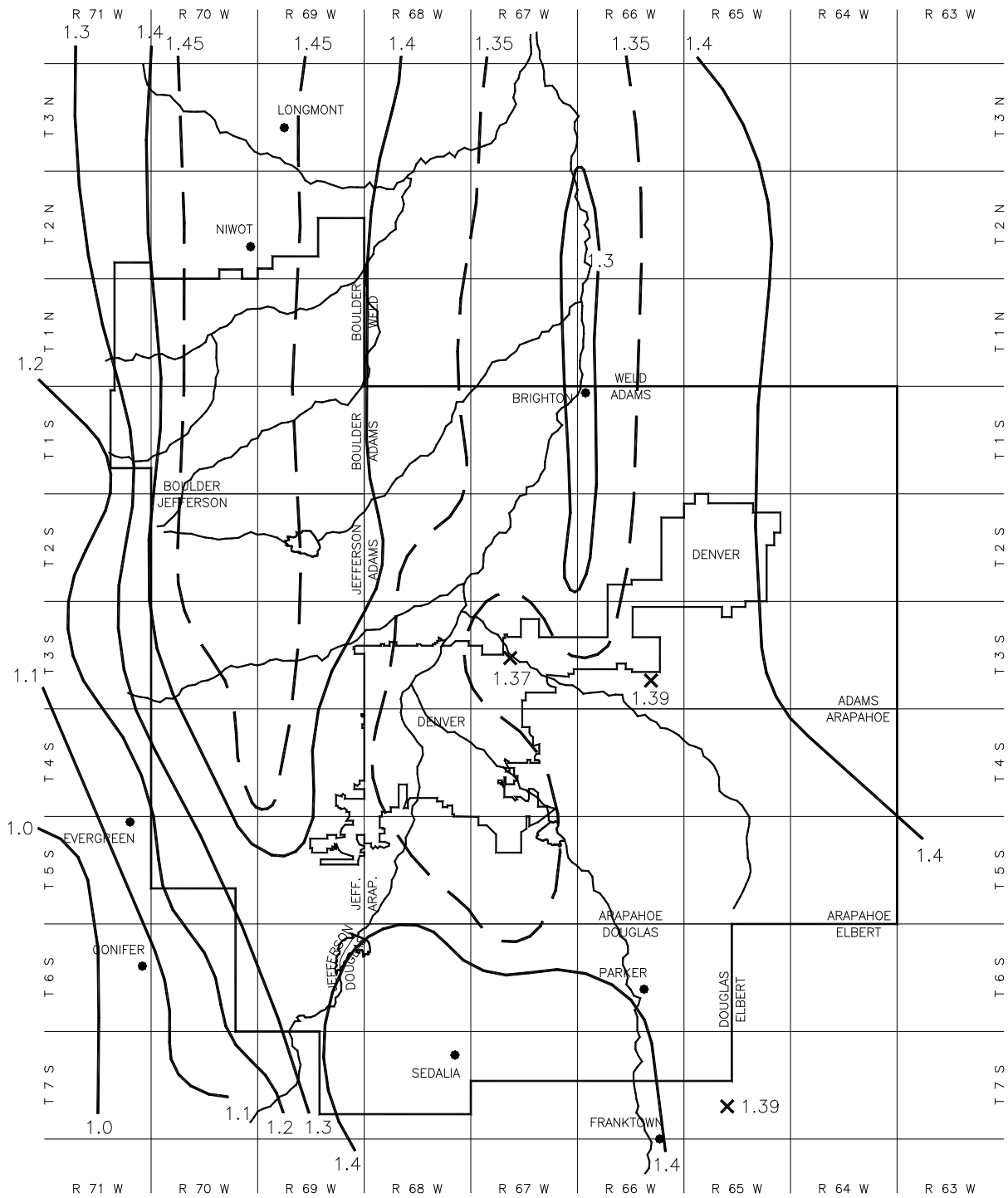
$T_d$  = storm duration (minutes)

## 5.0 UD-Rain Excel Workbook

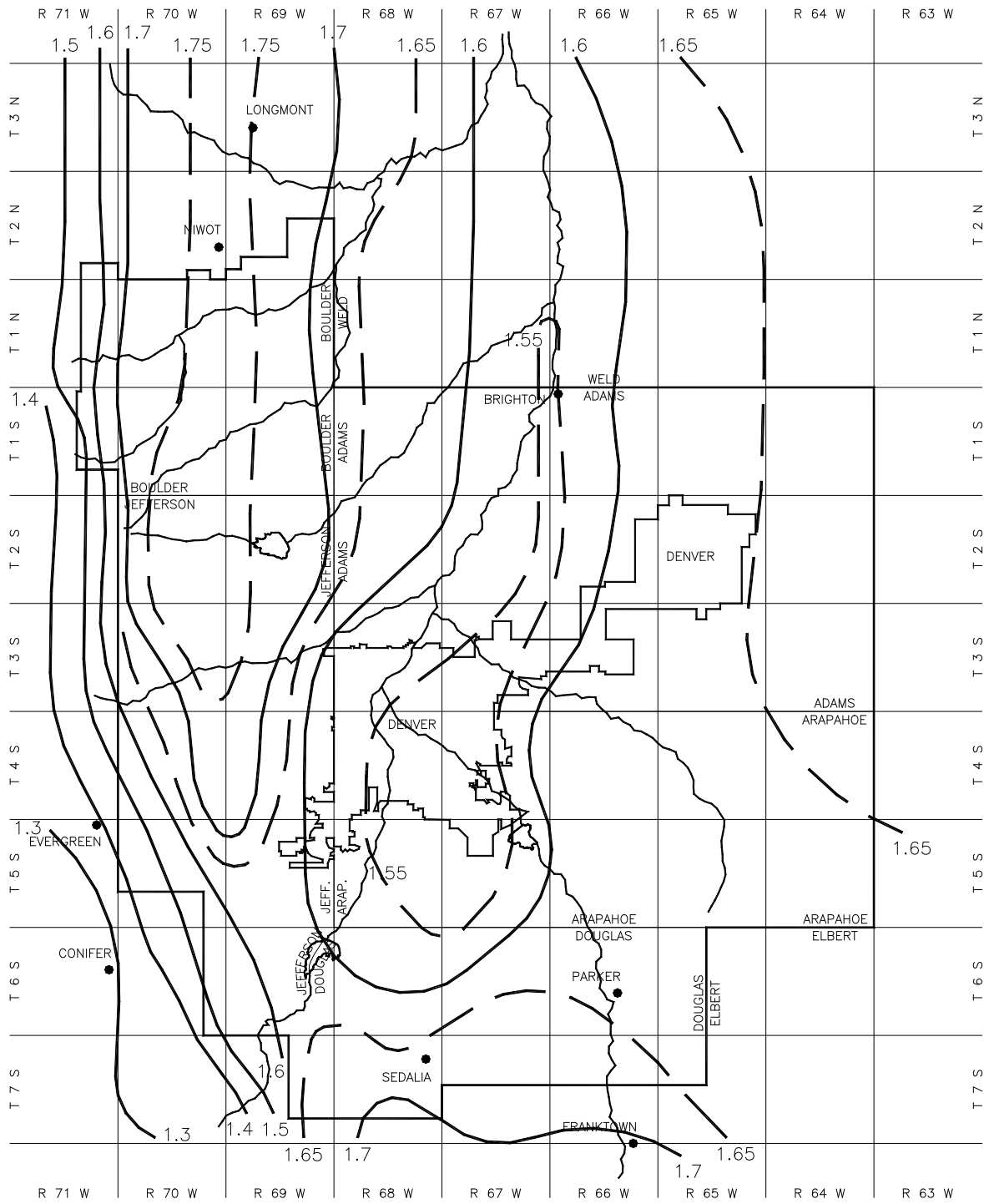
The UD-Rain Excel workbook has been developed in order to facilitate computation of design rainfall. It applies the methods in the NOAA Atlas 2, Volume III to derive design rainfall statistics and create Depth-Duration-Frequency (DDF) and Intensity-Duration-Frequency (IDF) tables for any location within Colorado and includes elevation adjustments. This workbook also prepares a temporal distribution of the Design Rainfall for the 2-, 5-, 10-, 25-, 50-, 100- and 500-yr events within the UDFCD boundary including depth reduction factors (DRFs) for use with CUHP and SWMM modeling.

UD-Rain and CUHP may provide slightly different results for the rainfall distribution than the procedure outlined in this chapter due to a smoothing method implemented in the programming which eliminates potential dips in the hyetograph.

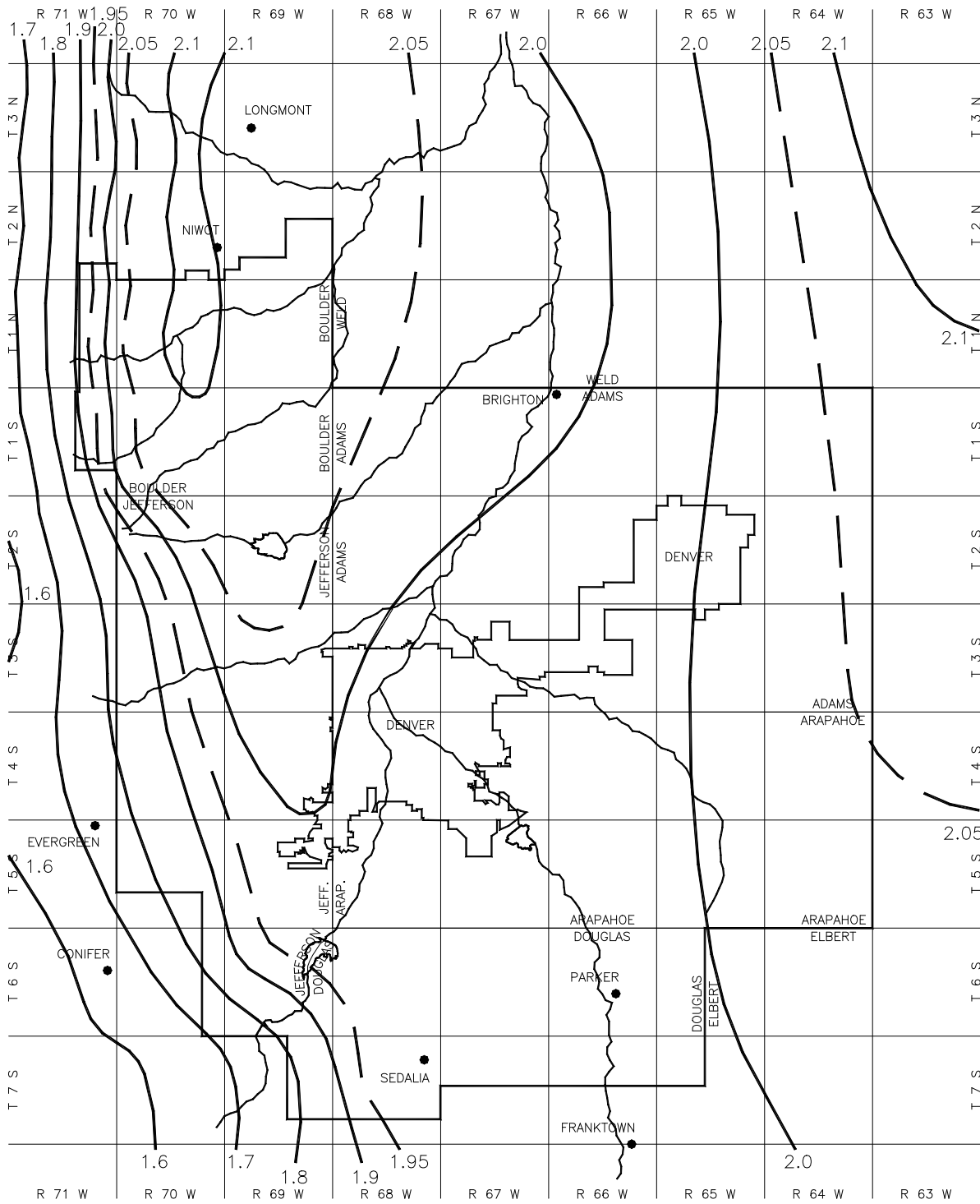




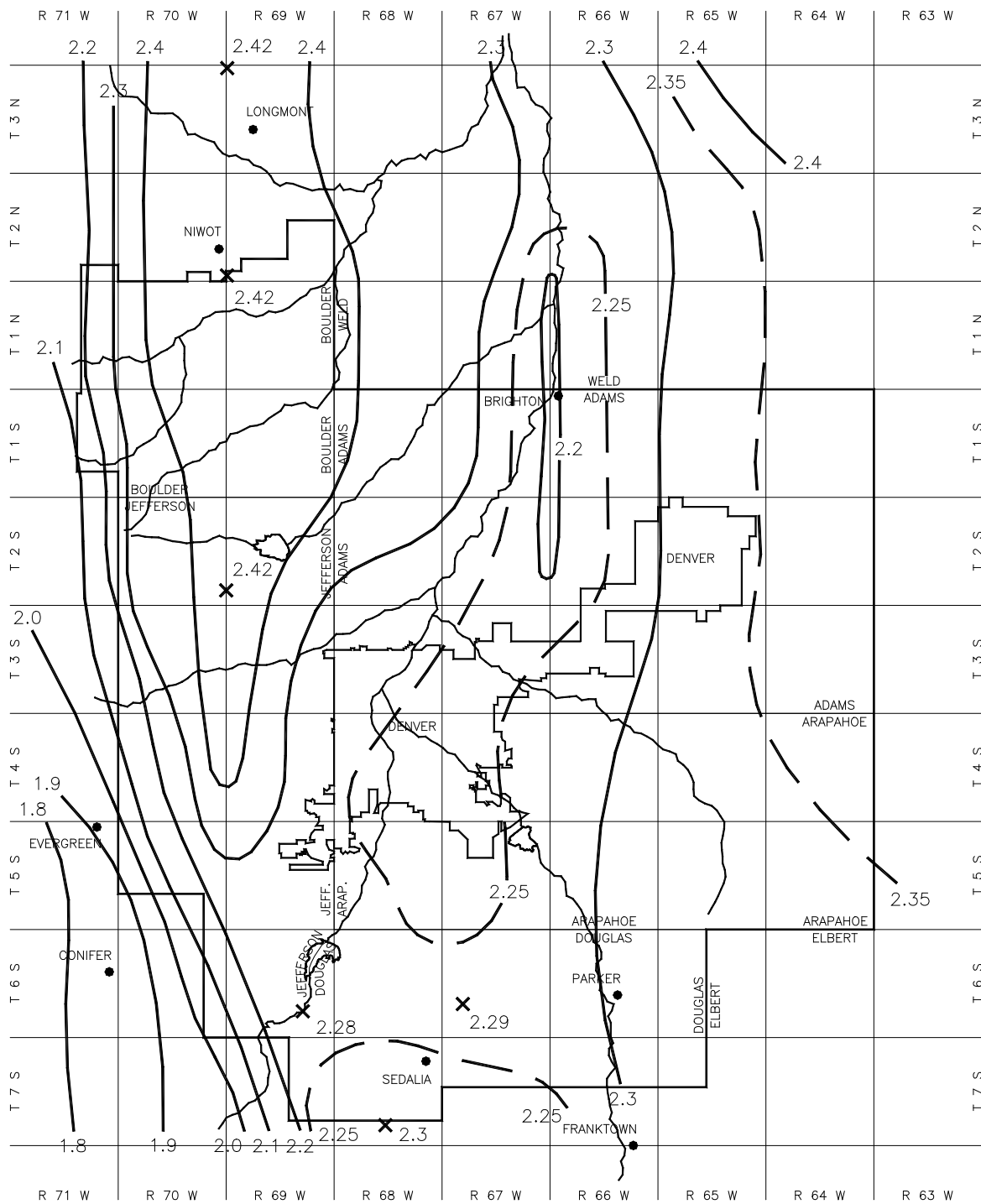
**Figure 5-2. Rainfall depth-duration-frequency: 5-year, 1-hour rainfall**



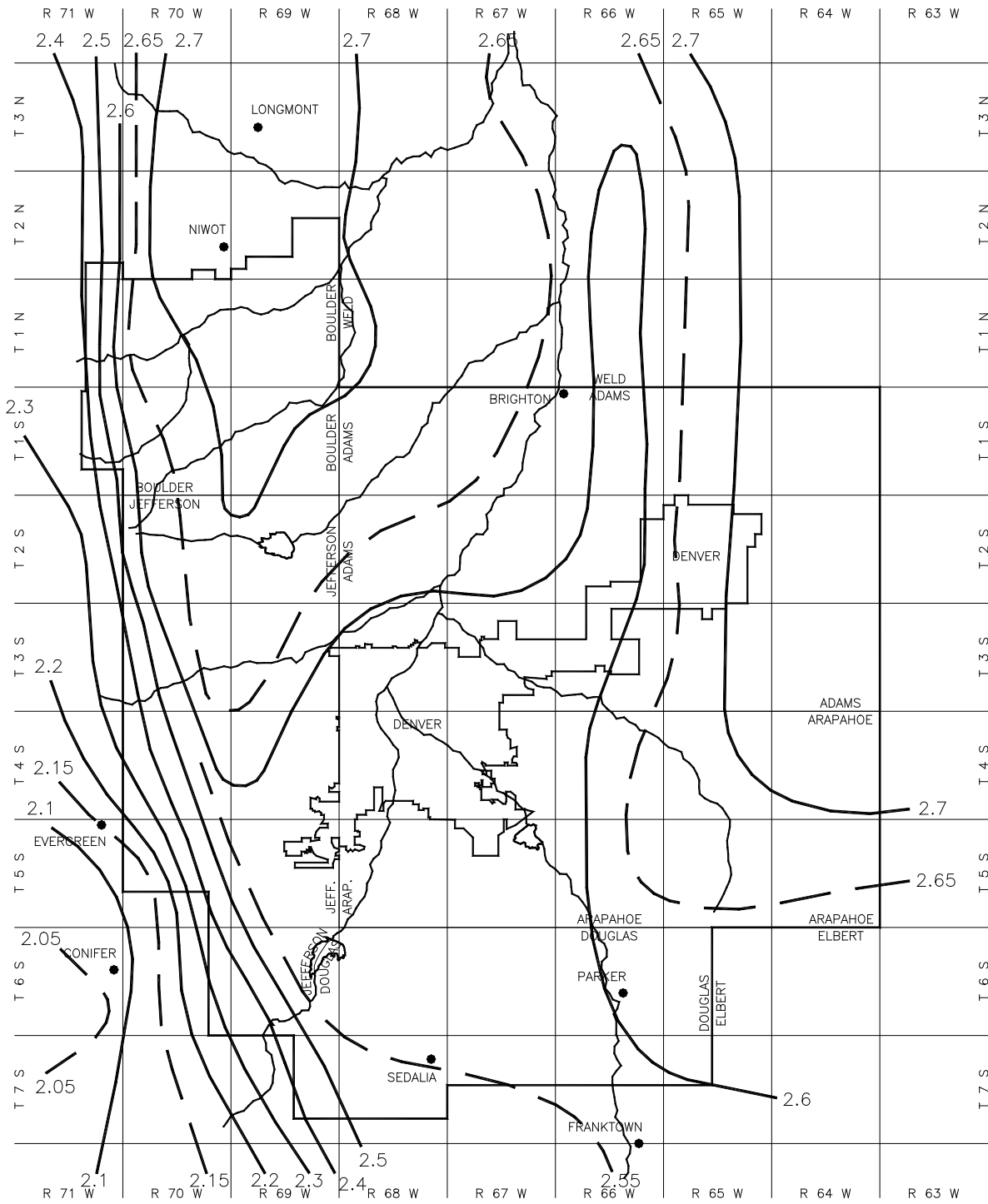
**Figure 5-3. Rainfall depth-duration-frequency: 10-year, 1-hour rainfall**



**Figure 5-4. Rainfall depth-duration-frequency: 25-Year, 1-hour rainfall**

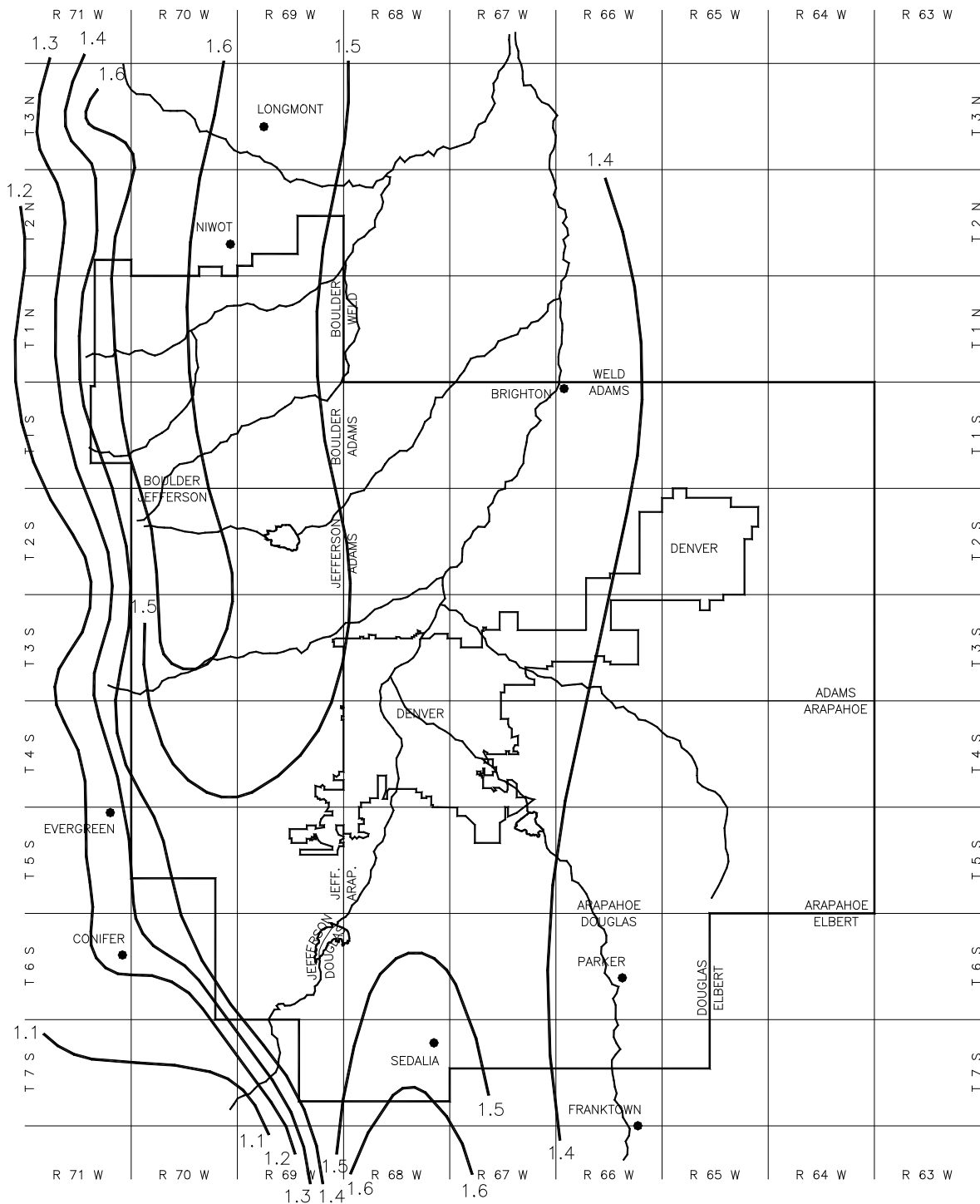


**Figure 5-5. Rainfall depth-duration-frequency: 50-year, 1-hour rainfall**

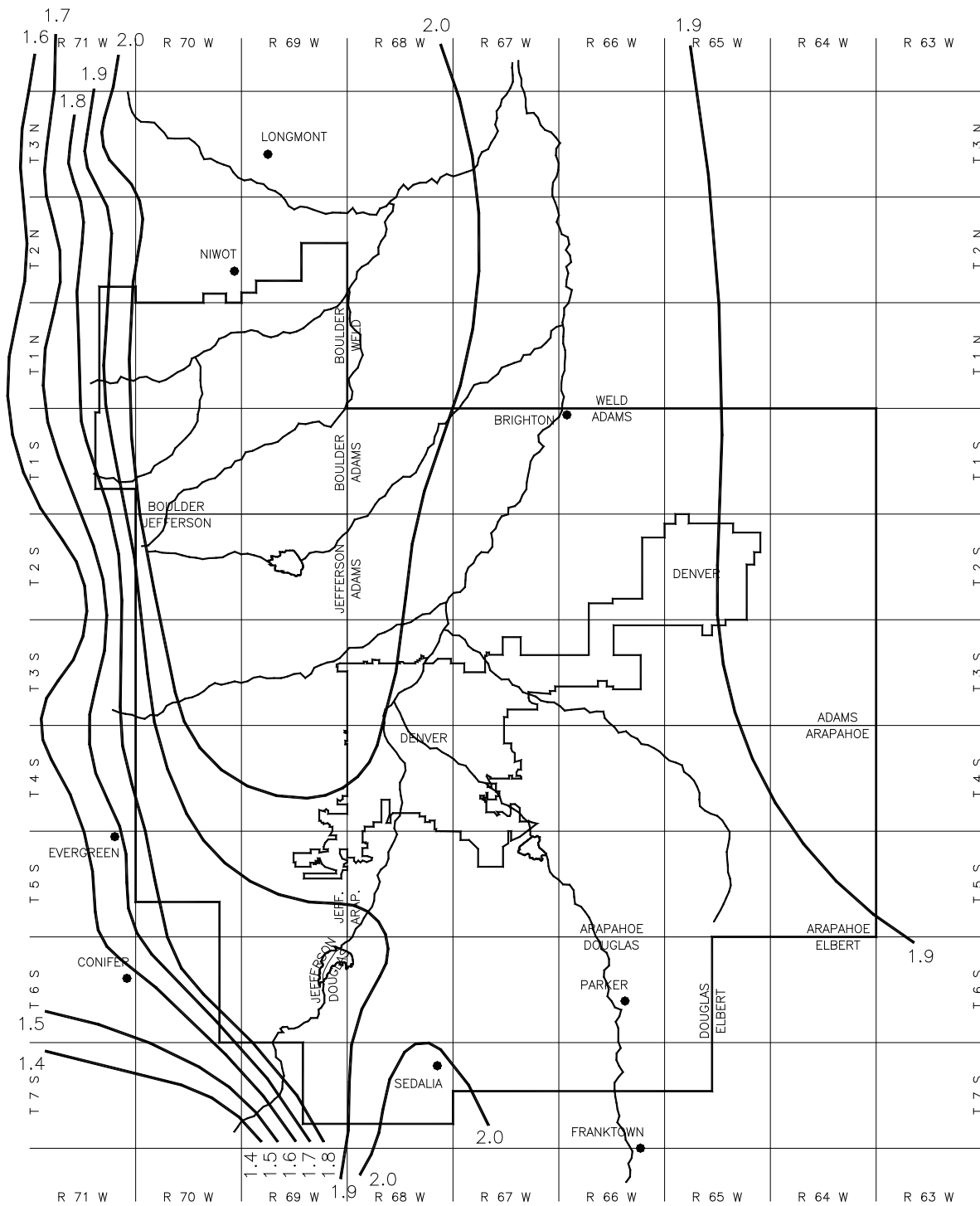


**Figure 5-6. Rainfall depth-duration-frequency: 100-year, 1-hour rainfall**

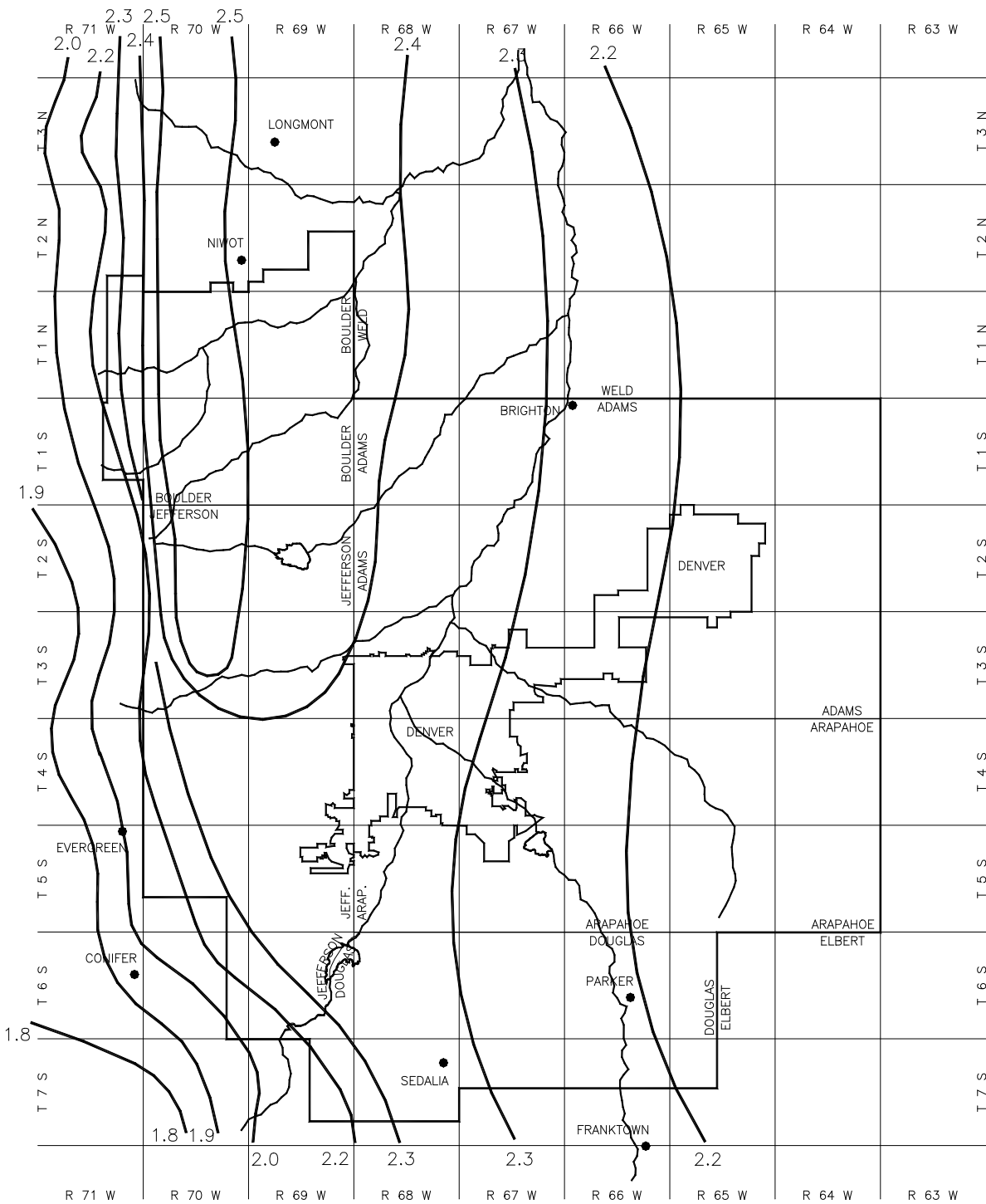




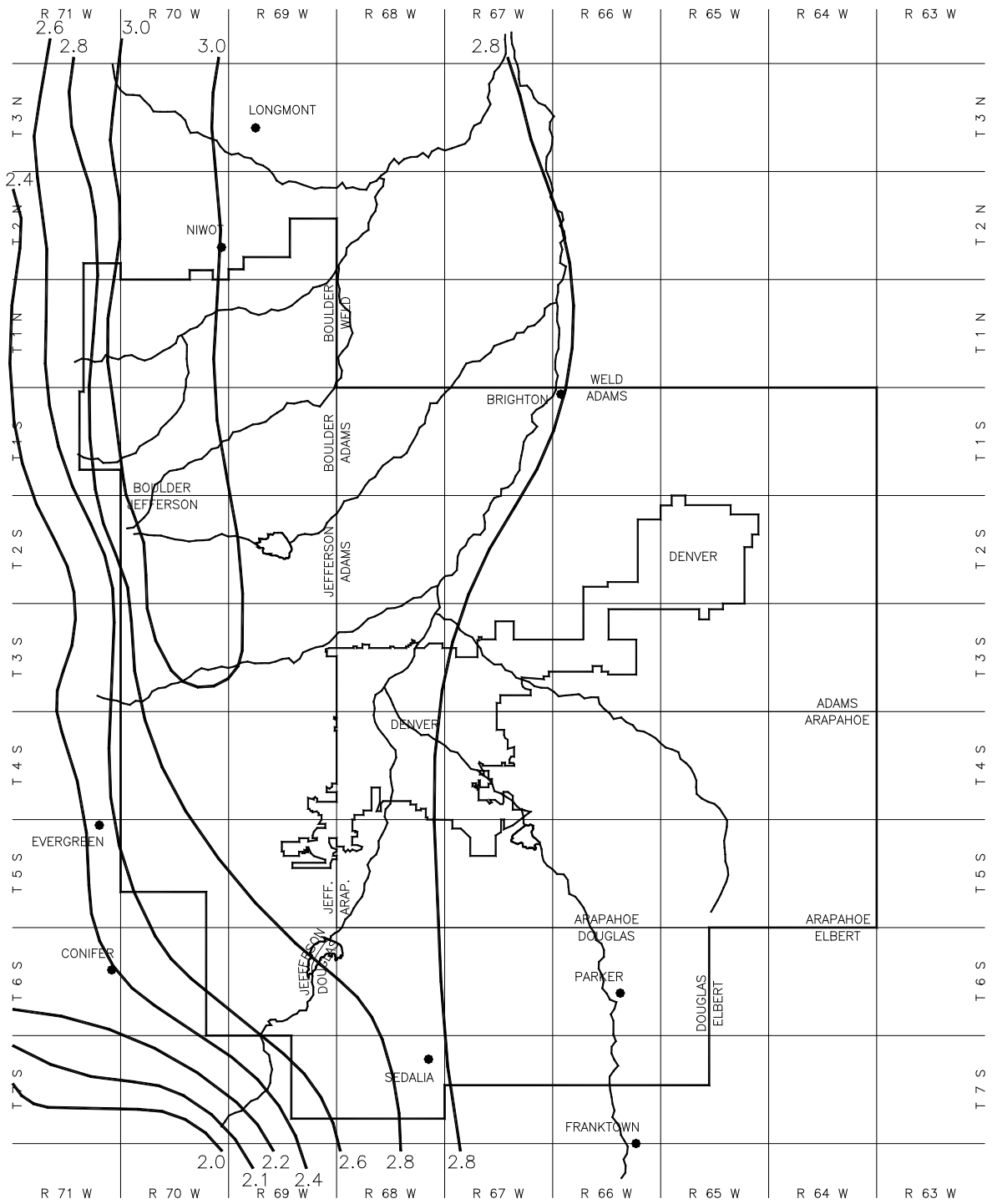
**Figure 5-7. Rainfall depth-duration-frequency: 2-year, 6-hour rainfall**



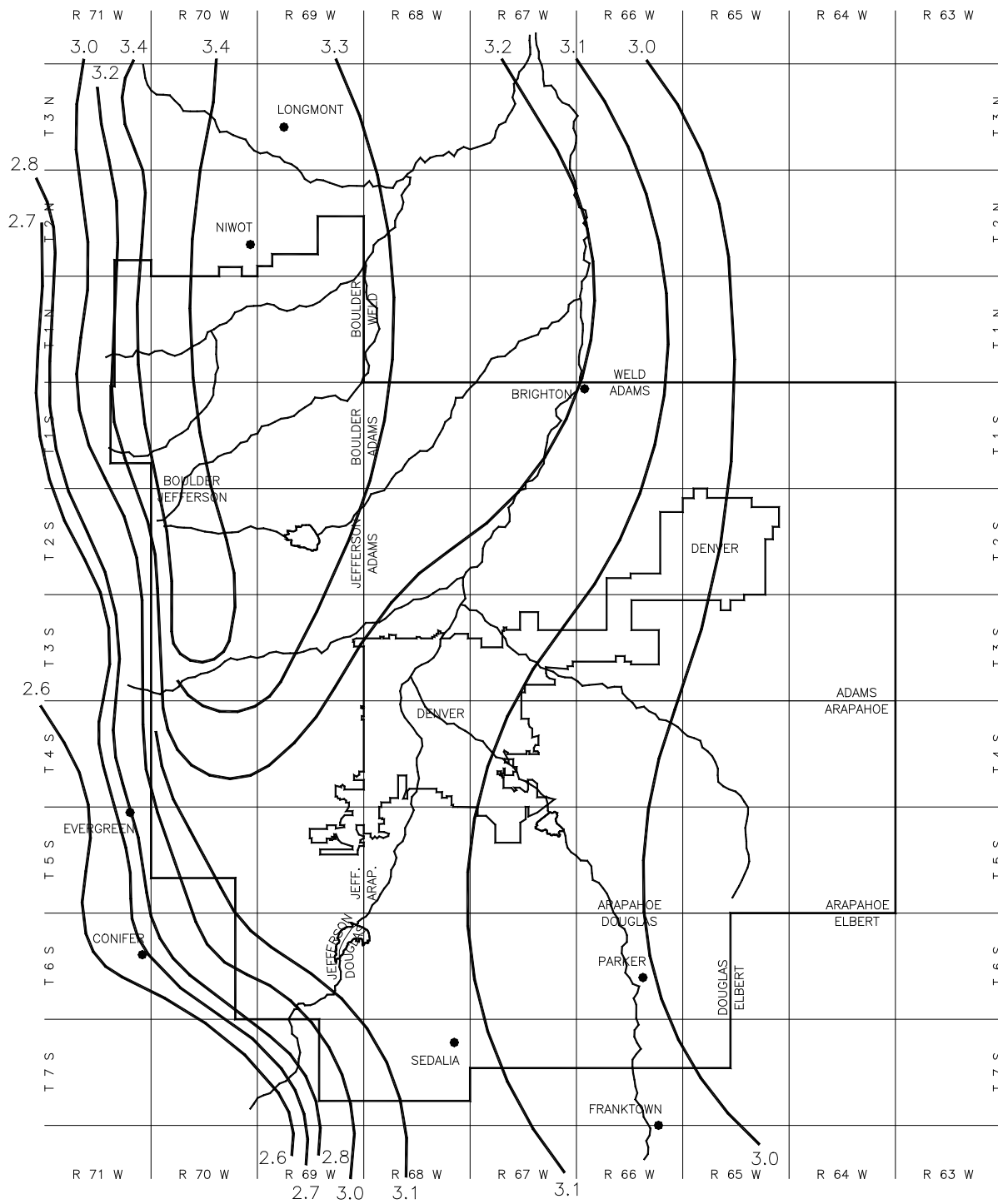
**Figure 5-8. Rainfall depth-duration-frequency: 5-year, 6-hour rainfall**



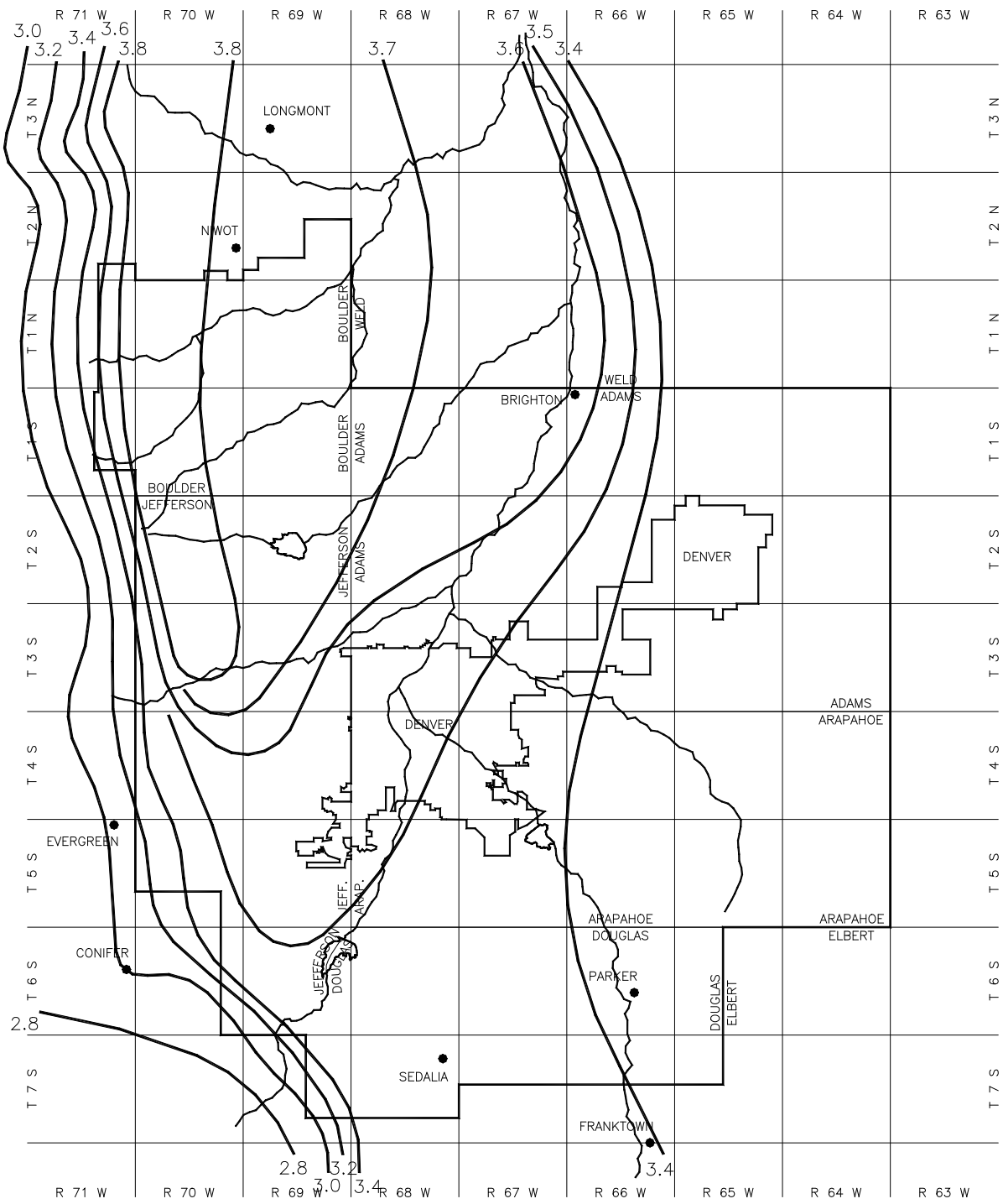
**Figure 5-9. Rainfall depth-duration-frequency: 10-year, 6-hour rainfall**



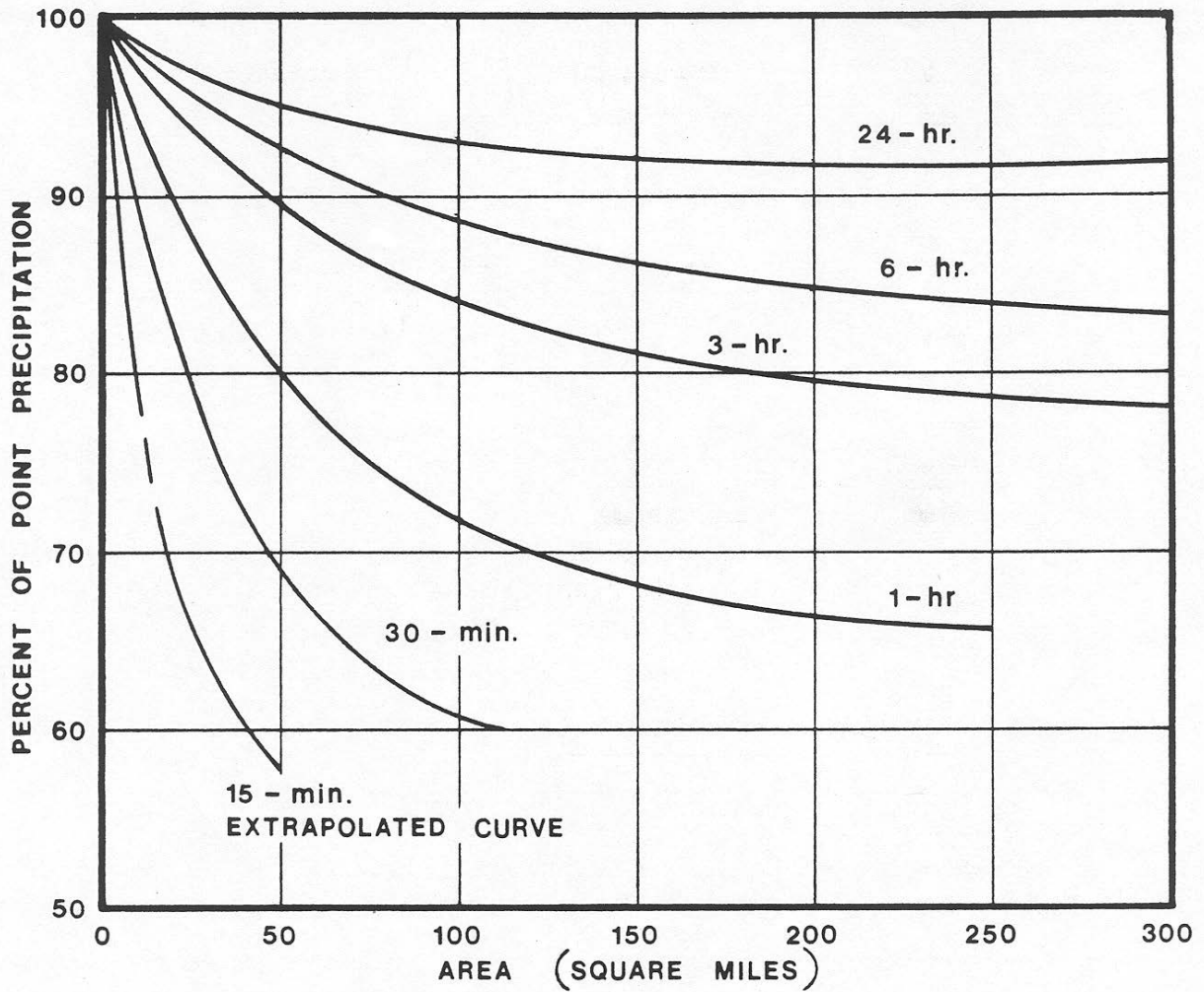
**Figure 5-10. Rainfall depth-duration-frequency: 25-year, 6-hour rainfall**



**Figure 5-11. Rainfall depth-duration-frequency: 50-year, 6-hour rainfall**



**Figure 5-12. Rainfall depth-duration-frequency: 100-year, 6-hour rainfall**



**Figure 5-13. Depth reduction factor (DRF) curves for infrequent storm events**

(25-, 50-, 100- and 500-year events) (NOAA Atlas 2, Volume III 1973 with extrapolation for 15-minute curve)

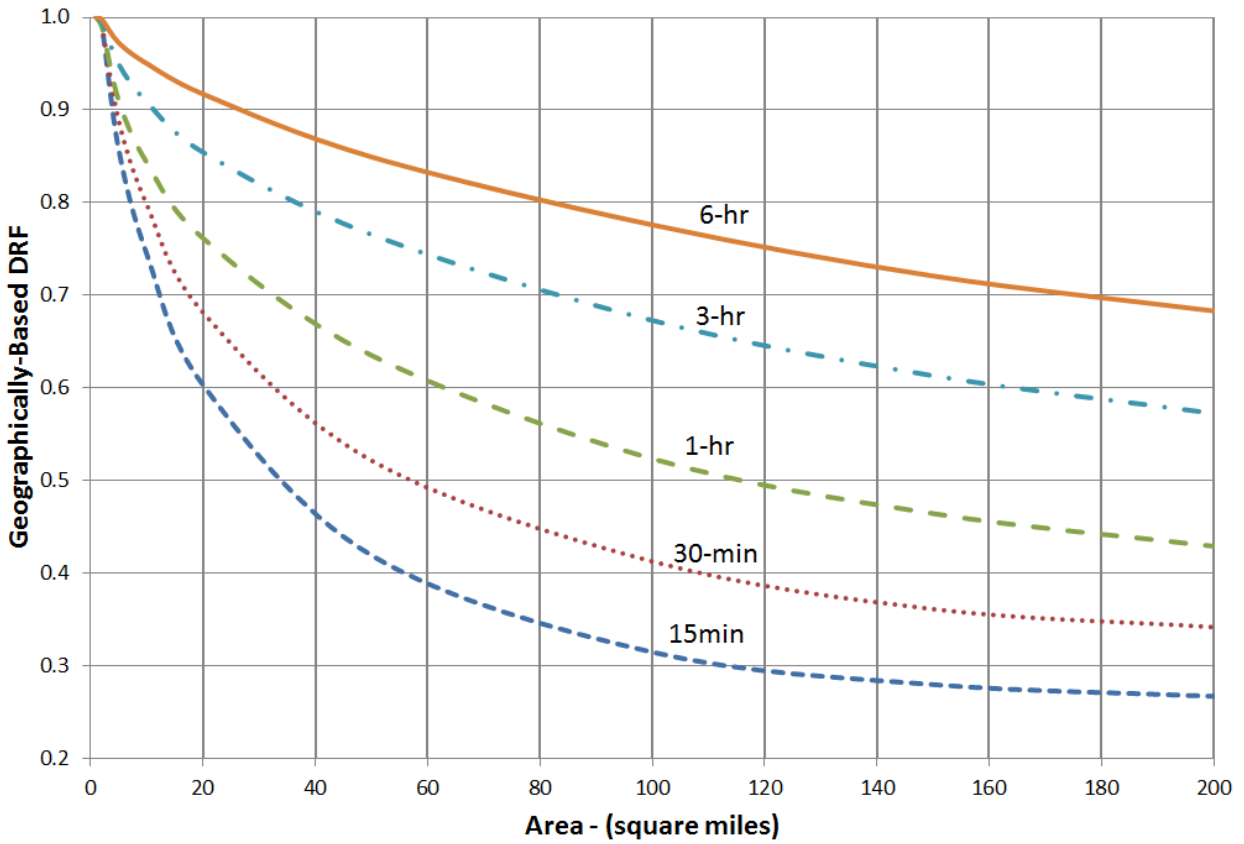


Figure 5-14. Depth reduction factor (DRF) curves for minor storm events (2-, 5-, and 10-year events)

(Carlton 2010)



## 6.0 Examples

### 6.1 Example Computation of Point Rainfall

Find the 2-hour and 3-hour point precipitation values for the 2-year and 100-year design storm in the location of Section 1, Township 1 South, Range 68 West.

Determine 1-hour and 6-hour point rainfall values from Figures 5-1, 5-6, 5-7, and 5-12.

Data from Figures 5-1 through 5-12:

Storm Event	Point Precipitation (Inches)	Figure Reference
2-year, 1-hour	0.95	5-1
2-year, 6-hour	1.46	5-7
100-year, 1-hour	2.67	5-6
100-year, 6-hour	3.67	5-12

Determine 2-hour point precipitation values from Equation 5-1:

$$P_2 (2\text{-year}) = 2\text{-year, 2-hour} = 0.95 + (1.46 - 0.95) \cdot 0.342 = 1.12 \text{ inches}$$

$$P_2 (100\text{-year}) = 100\text{-year, 2-hour} = 2.67 + (3.67 - 2.67) \cdot 0.342 = 3.01 \text{ inches}$$

Determine 3-hour point precipitation values from Equation 5-2:

$$P_3 (2\text{-year}) = 2\text{-year, 3-hour} = 0.95 + (1.46 - 0.95) \cdot 0.597 = 1.25 \text{ inches}$$

$$P_3 (100\text{-year}) = 100\text{-year, 3-hour} = 2.67 + (3.67 - 2.67) \cdot 0.597 = 3.27 \text{ inches}$$

## 6.2 Example preparation of intensity-duration-frequency curve

Use Equation 5-3 to plot rainfall intensity-duration curves for the 100-year, 10-year, 5-year, and 2-year precipitation events in Denver. One-hour point precipitation values in Denver are as follows: 100-year (2.6-inch), 10-year (1.55-inch), 5-year (1.35 inches), and 2-year (0.95-inches).

Rainfall intensity-duration values derived for 100-year 1-hour point precipitation value (2.6-inch):

Calculations are prepared using Equation 5-3.

Duration (minutes)	Rainfall Intensity (inches/hour)
5	$28.5 \cdot 2.6 / (10 + 5)^{0.786} = 8.82$
10	$28.5 \cdot 2.6 / (10 + 10)^{0.786} = 7.03$
15	$28.5 \cdot 2.6 / (10 + 15)^{0.786} = 5.90$
30	$28.5 \cdot 2.6 / (10 + 30)^{0.786} = 4.08$
60	$28.5 \cdot 2.6 / (10 + 60)^{0.786} = 2.63$

Repeat this exercise for each return period.

Duration	P <sub>1</sub>	5	10	15	30	60
<b>2-year</b>	0.95	3.22	2.57	2.16	1.49	0.96
<b>5-year</b>	1.35	4.58	3.65	3.06	2.12	1.36
<b>10-year</b>	1.55	5.26	4.19	3.52	2.43	1.57
<b>100-year</b>	2.6	8.82	7.03	5.90	4.08	2.63

The values from Equation 5-3 are plotted in Figure 5-15.

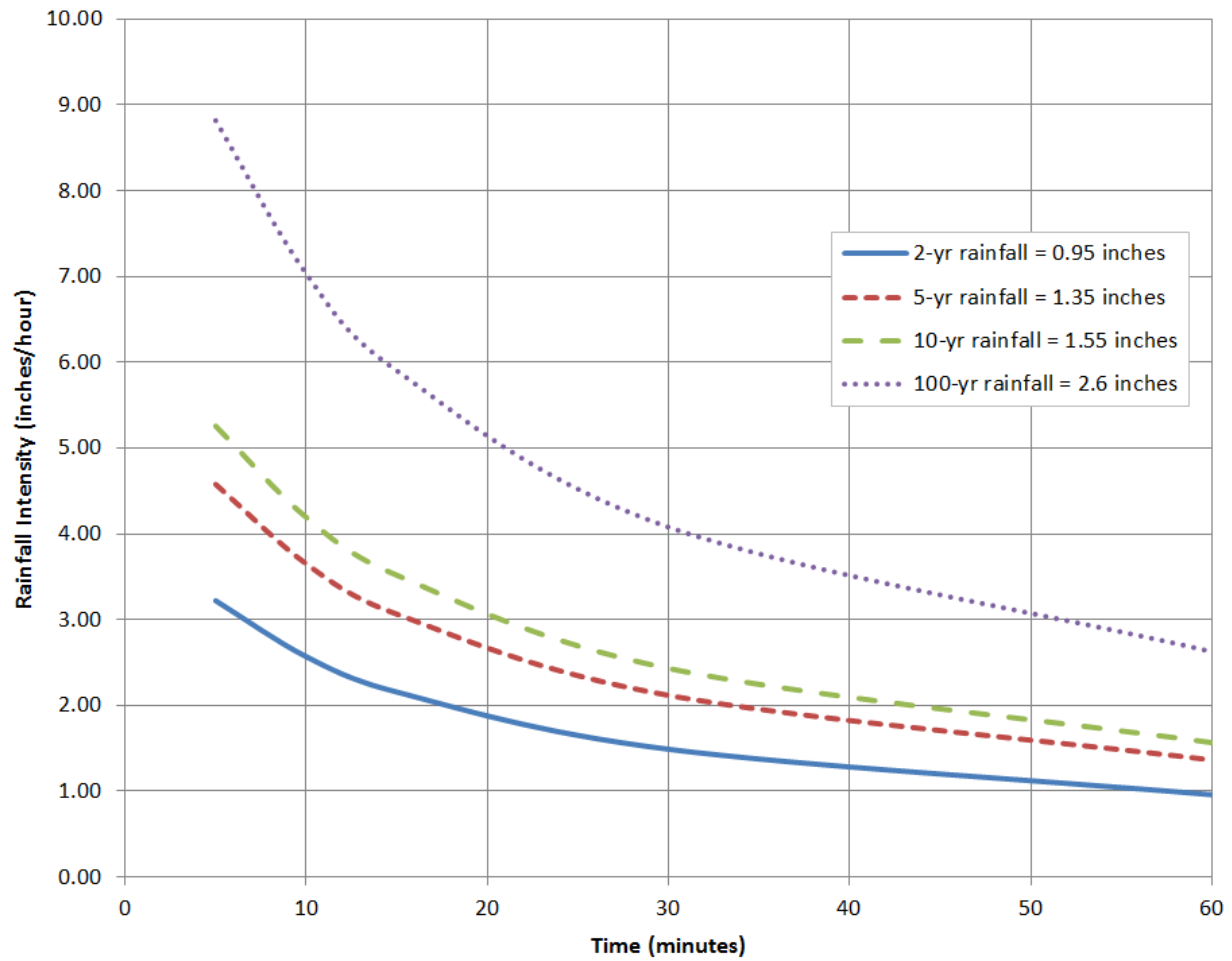


Figure 5-15. Example rainfall intensity-duration curves

### 6.3 Example preparation of intensity-duration-frequency table and rainfall distribution using UD-rainfall.

On the *DDF & IDF Tables* tab, Enter the hydrologic zone and select “Denver – Capitol Hill” as the location of the watershed.

**Depth-Duration-Frequency and Intensity-Duration-Frequency Tables for Colorado Hydrologic Zones 1 through 4**

Blue cells are inputs.

Help filling out this worksheet

**Project:** \_\_\_\_\_

Where is the Watershed Located?

Located within UDFCD Boundary

Located outside of UDFCD Boundary

Hydrologic Zone (1, 2, 3, or 4) =  (see map)

Elevation at Center of Watershed =  ft

Watershed Area (Optional) =  sq. mi.

(Optional) Select a location within the UDFCD boundary:  ▼

Longitude: 39° 44' 02" Latitude: 104° 58' 47" W

The rainfall intensity duration frequency table will automatically populate.

#### 2. Rainfall Intensity-Duration-Frequency Table

Return Period	Rainfall Intensity in Inches Per Hour at Time Duration								
	5-min	10-min	15-min	30-min	1-hr	2-hr	3-hr	6-hr	24-hr
2-yr	3.22	2.57	2.16	1.49	0.95	0.59	0.44	0.26	0.09
5-yr	4.58	3.65	3.06	2.12	1.35	0.84	0.62	0.37	0.13
10-yr	5.26	4.19	3.52	2.43	1.55	0.96	0.71	0.42	0.14
25-yr	6.78	5.41	4.54	3.14	2.00	1.24	0.92	0.55	0.19
50-yr	7.60	6.06	5.09	3.51	2.24	1.39	1.03	0.61	0.21
100-yr	8.75	6.98	5.86	4.05	2.58	1.60	1.19	0.70	0.24
500-yr	10.91	8.70	7.30	5.05	3.22	2.00	1.48	0.88	0.30

**Note:** Intensity approximated using 1-hr rainfall depths and Equation 4-3 in USDCM Volume 1.

Note that some of these values are different than in example 6.2. UD-Rain and CUHP may provide slightly different results for the rainfall distribution than the procedure outlined in this chapter (and demonstrated in example 6.2) due to a smoothing method implemented in the programming which eliminates potential dips in the hyetograph.

Tables showing rainfall distribution of the 2-year, 5-year, 10-year, 25-year, 50-year, 100-year, and 500-year design storms also automatically populate and provide distributions for several different watershed areas including a user-defined area. Values include DRF where applicable (based on watershed size).

## 7.0 References

Carlton Engineering, Inc. 2010. *Final Report: Fountain Creek Watershed Rainfall Characterization Study*. Prepared for City of Colorado Springs, September 2010.

National Oceanic and Atmospheric Administration (NOAA) 1973. *NOAA Atlas 2: Precipitation-Frequency Atlas of the Western United States, Volume III-Colorado*. Washington, D.C.: U.S. Department of Commerce, National Weather Service.

Urbonas, B. 1979. Reliability of Design Storms In Modeling. In *Proceedings International Symposium on Urban Storm Runoff*, 27-36. Lexington, KY: University of Kentucky.

Urbonas, B. 1978. Some Findings in the Rainfall-Runoff Data Collected in the Denver Area. *Flood Hazard News* 18(1):10.

# Chapter 6

## Runoff

### Contents

<b>1.0</b>	<b>Overview .....</b>	<b>1</b>
<b>2.0</b>	<b>Rational Method.....</b>	<b>2</b>
2.1	Rational Formula.....	2
2.2	Assumptions.....	3
2.3	Limitations .....	4
2.4	Time of Concentration .....	4
2.4.1	Initial or Overland Flow Time .....	5
2.4.2	Channelized Flow Time .....	5
2.4.3	First Design Point Time of Concentration in Urban Catchments.....	6
2.4.4	Minimum Time of Concentration .....	6
2.4.5	Common Errors in Calculating Time of Concentration .....	6
2.5	Rainfall Intensity.....	7
2.5.1	Runoff Coefficient .....	7
<b>3.0</b>	<b>Colorado Urban Hydrograph Procedure.....</b>	<b>13</b>
3.1	Background .....	13
3.2	Effective Rainfall for CUHP .....	13
3.2.1	Pervious-Impervious Areas.....	13
3.2.2	Depression Losses.....	14
3.2.3	Infiltration .....	14
3.3	CUHP Parameter Selection .....	16
3.3.1	Rainfall.....	16
3.3.2	Catchment Description.....	16
3.3.3	Catchment Delineation Criteria.....	18
3.3.4	Combining and Routing Subcatchment CUHP Hydrographs .....	18
<b>4.0</b>	<b>EPA SWMM And Hydrograph Routing.....</b>	<b>20</b>
4.1	Software Description.....	20
4.1.1	Surface Flows and Flow Routing Features .....	20
4.1.2	Flow Routing Method of Choice.....	21
4.2	Data Preparation for the SWMM Software .....	21
4.2.1	Step 1: Method of Discretization .....	21
4.2.2	Step 2: Estimate Coefficients and Functional/Tabular Characteristic of Storage and Outlets ...	22
4.2.3	Step 3: Preparation of Data for Computer Input .....	23
<b>5.0</b>	<b>Other Hydrologic Methods.....</b>	<b>23</b>
5.1	Published Hydrologic Information.....	23
5.2	Statistical Methods.....	23
<b>6.0</b>	<b>Software .....</b>	<b>24</b>
<b>7.0</b>	<b>Examples .....</b>	<b>25</b>
7.1	Rational Method Example 1 .....	25
7.2	Rational Method Example 2.....	27

## Tables

Table 6-1. Applicability of hydrologic methods .....2  
Table 6-2. NRCS Conveyance factors, K.....5  
Table 6-3. Recommended percentage imperviousness values .....8  
Table 6-4. Runoff coefficient equations based on NRCS soil group and storm return period.....9  
Table 6-5. Runoff coefficients, *c*.....10  
Table 6-5. Runoff coefficients, *c* (continued) .....11  
Table 6-6. Typical depression losses for various land covers .....14  
Table 6-7. Recommended Horton’s equation parameters .....15

## Figures

Figure 6-1. Runoff coefficient vs. watershed imperviousness NRCS HSG A .....11  
Figure 6-2. Runoff coefficient vs. watershed imperviousness NRCS HSG B .....12  
Figure 6-3. Runoff coefficient vs. watershed imperviousness NRCS HSG C and D.....12  
Figure 6-4. Slope correction for streams and vegetated channels .....19

## 1.0 Overview

The importance of accurate runoff quantification cannot be overstated. Estimates of peak rate of runoff, runoff volume, and the time distribution of flow provide the basis for all planning, design, and construction of drainage facilities. Erroneous hydrology results in infrastructure that is either undersized, oversized, or out of hydraulic balance. At the same time it is important to understand that the result of the runoff analysis is an approximation. Thus, the intent of this chapter is to provide a reasonably dependable and consistent method of approximating the characteristics of urban runoff for areas of Colorado and the United States having similar meteorology and hydrology to what is found within the Urban Drainage and Flood Control District (UDFCD) region. Five methods of hydrologic analysis are described in the Urban Storm Drainage Criteria Manual (USDCM):



**Photograph 6-1.** Devastating flooding from Gregory Canyon Creek in Boulder in September 2013 emphasizes the importance of accurate flood flow projections.

1. The Rational Method,
2. The Colorado Urban Hydrograph Procedure (CUHP) for generating hydrographs from watersheds,
3. The EPA's Storm Water Management Model (SWMM), mostly for combining and routing the hydrographs generated using CUHP,
4. Use of published runoff information, and
5. Statistical analyses.

Most of this chapter focuses on the Rational Method and CUHP in combination with SWMM routing. A summary of applicability of both methods is provided in Table 6-1.

The Rational Method can be used to analyze the design storm runoff from urban catchments that are not complex and that are generally 90 acres or less and when only the peak flow rate is needed (e.g., storm drain sizing). Calculations for the Rational Method can be carried out by hand or using the UD-Rational Excel workbook available at [www.udfcd.org](http://www.udfcd.org).

CUHP has been used extensively in this region since 1969. It has been calibrated for the UDFCD region using data that were collected for a variety of watershed conditions. The vast majority of major drainage systems within UDFCD have been designed based upon the hydrology calculated using CUHP and a customized version of the EPA's Stormwater Management Model (SWMM), runoff block, named the Urban Drainage Stormwater Model (UDSWM). In 2005, UDFCD began using and recommending the EPA's SWMM Version 5 and upgraded the CUHP software to be compatible with that model. CUHP and SWMM should be used for larger catchments or when a hydrograph of the storm event is needed.

There have been hydrologic studies carried out for a majority of the major drainage systems within UDFCD and published flow data are available for most of these systems.



Statistical analyses may be used in certain situations outside the UDFCD boundary. The use of this approach requires the availability of acceptable, appropriate, and adequate data.

**Table 6-1. Applicability of hydrologic methods**

Watershed Size (acres)	Is the Rational Method Applicable?	Is CUHP Applicable?
0 to 90	Yes	Yes
90 to 160	No	Yes
160 to 3,000	No	Yes <sup>1</sup>
Greater than 3,000	No	Yes (subdividing into smaller catchments required) <sup>1</sup>

1. Subdividing into smaller subcatchments and routing the resultant hydrographs using SWMM may be needed to accurately model a catchment with areas of different soil types or percentages of imperviousness.

When modeling large watersheds, the subcatchment sizes can influence results. If heterogeneous land uses are “lumped” together into large subcatchments, the models may not accurately account for the “flashy” nature of runoff from impervious surfaces, and peak rates of runoff may be underestimated. On the other hand, selecting subcatchments that are very small can lead to complicated and unrealistic routing that can overestimate peak rates of runoff.

The quantity of stormwater runoff from an urban site is also related to site characteristics (e.g., lot size, soil type, slope, vegetation, impervious area) and stormwater measures used to control runoff from the site (e.g., site grading, disconnecting impervious areas from the drainage system, detention facilities, buffer zones, low impact development practices, and other structural and nonstructural best management practices). Implementation of Low Impact Development (LID) strategies, including measures to “minimize directly connected impervious areas” (MDCIA), reduces runoff peaks and volumes from urban areas. These practices involve site planning to minimize impacts to sensitive site features, methods to reduce the overall amount of impervious areas, and routing of runoff from impervious surfaces over permeable areas to slow runoff (increase time of concentration) and promote onsite storage and infiltration. Additional information on LID practices is provided in Volume 3 of the USDCM.

## 2.0 Rational Method

For urban catchments that are not complex and are generally 90 acres or less in size, it is acceptable to use the Rational Method for design storm analysis. This method was introduced in 1889 and is still being used in most engineering offices in the United States. Even though this method has frequently come under academic criticism for its simplicity, no other practical drainage design method has evolved to such a level of general acceptance by the practicing engineer. The Rational Method, properly understood and applied, can produce satisfactory results for urban storm drain design and small on-site detention design and for sizing of street inlets and storm drains.

### 2.1 Rational Formula

The Rational Method is based on the Rational Formula:

$$Q = CIA \quad \text{Equation 6-1}$$

Where:

$Q$  = the peak rate of runoff (cfs)

$C$  = Runoff coefficient—a non-dimensional coefficient equal to the ratio of runoff volume to rainfall volume

$I$  = average intensity of rainfall for a duration equal to the time of concentration,  $t_c$  (inches/hour)

$A$  = tributary area (acres).

Actually,  $Q$  has a unit of inches per hour per acre (in/hour/ac); however, since this rate of acre-inches/hour differs from cubic feet per second (cfs) by less than one percent, the more common units of cfs are used. The time of concentration is defined as the time required for water to flow from the most remote point of the tributary area to the design point, and is determined for the selected flow length that represents the longest waterway through a rural watershed or the most representative flow path through the impervious portion in an urban catchment.

The general procedure for Rational Method calculations for a single catchment is as follows:

1. Delineate the catchment boundary and determine its area.
2. Define the flow path from the upper-most portion of the catchment to the design point. This flow path should be divided into reaches of similar flow type (e.g., overland flow, shallow swale flow, gutter flow, etc.). Determine the length and slope of each reach.
3. Determine the time of concentration,  $t_c$ , for the selected waterway.
4. Find the rainfall intensity,  $I$ , for the design storm using the calculated  $t_c$  and the rainfall intensity-duration-frequency curve (see *Rainfall* chapter).
5. Determine the runoff coefficient,  $C$ .
6. Calculate the peak flow rate,  $Q$ , from the catchment using Equation 6-1.

## 2.2 Assumptions

The basic assumptions for the application of the Rational Method include:

1. The computed maximum rate of runoff to the design point is a function of the average rainfall rate during the time of concentration to that point.
2. The hydrologic losses in the catchment are homogeneous and uniform. The runoff coefficients are varied with respect to type of soils, imperviousness percentage, and rainfall frequencies. These coefficients represent the average soil antecedent moisture condition.
3. The depth of rainfall used is one that occurs from the start of the storm to the time of concentration, and the design rainfall depth during that time period is converted to the average rainfall intensity for that period.
4. The maximum runoff rate occurs when the entire area is contributing flow. This assumption is not valid where a more intensely developed portion of the catchment with a shorter time of concentration produces a higher rate of runoff than the entire catchment with a longer time of concentration.

### 2.3 Limitations

The Rational Method is the simplistic approach for estimating the peak flow rate and total runoff volume from a design rainstorm in a given catchment. Under the assumption of uniform hydrologic losses, the method is limited to catchments smaller than 90 acres. Under the condition of composite soils and land uses, the area-weighted method is recommended to derive the catchment's hydrologic parameters.

The greatest drawback to the Rational Method is that it normally provides only one point (the peak flow rate) on the runoff hydrograph. When the areas become complex and where subcatchments come together, the Rational Method will tend to overestimate the actual flow, which results in oversizing of drainage facilities. The Rational Method provides no means or methodology to generate and route hydrographs through drainage facilities. One reason the Rational Method is limited to small areas is that good design practice requires the routing of hydrographs for larger catchments to achieve an economically sound design.

Another disadvantage of the Rational Method is that with typical design procedures, one normally assumes that all of the design flow is collected at the design point and that there is no water running overland to the next design point. This is not a fault of the Rational Method but of the design procedure. The Rational Method must be modified, or another type of analysis must be used, when analyzing an existing system that is under-designed or when analyzing the effects of a major storm on a system designed for the minor storm.

### 2.4 Time of Concentration

One of the basic assumptions underlying the Rational Method is that runoff is linearly proportional to the average rainfall intensity during the time required for water to flow from the most remote part of the drainage area to the design point. In practice, the time of concentration is empirically estimated along the selected waterway through the catchment.

The waterway is first divided into overland flow length and channelized flow lengths, according to the channel characteristics. For urban areas, the time of concentration,  $t_c$ , consists of an initial time or overland flow time,  $t_i$ , plus the channelized flow travel time,  $t_t$ , through the storm drain, paved gutter, roadside ditch, or channel. For non-urban areas, the time of concentration consists of an overland flow time,  $t_i$ , plus the time of travel in a defined drainage path, such as a swale, channel, or stream. The channelized flow travel time portion,  $t_t$ , of the time of concentration can be estimated from the hydraulic properties of the conveyance element. Initial or overland flow time, on the other hand, will vary with surface slope, depression storage, surface cover, antecedent rainfall, and infiltration capacity of the soil, as well as distance of surface flow. The time of concentration is computed by Equation 6-2 for both urban and non-urban areas:

$$t_c = t_i + t_t \quad \text{Equation 6-2}$$

Where:

$t_c$  = computed time of concentration (minutes)

$t_i$  = overland (initial) flow time (minutes)

$t_t$  = channelized flow time (minutes).

### 2.4.1 Initial or Overland Flow Time

The initial or overland flow time,  $t_i$ , may be calculated using Equation 6-3:

$$t_i = \frac{0.395(1.1 - C_5)\sqrt{L}}{S_o^{0.33}} \quad \text{Equation 6-3}$$

Where:

- $t_i$  = overland (initial) flow time (minutes)
- $C_5$  = runoff coefficient for 5-year frequency (from Table 6-4)
- $L$  = length of overland flow (ft)
- $S_o$  = average slope along the overland flow path (ft/ft).

Equation 6-3 is adequate for distances up to 300 feet in urban areas and 500 feet in rural areas. Note that in a highly urbanized catchment, the overland flow length is typically shorter than 300 feet due to effective man-made drainage systems that collect and convey runoff.

### 2.4.2 Channelized Flow Time

The channelized flow time (travel time) is calculated using the hydraulic properties of the conveyance element. The channelized flow time,  $t_t$ , is estimated by dividing the length of conveyance by the velocity. The following equation, Equation 6-4 (Guo 2013), can be used to determine the flow velocity in conjunction with Table 6-2 for the conveyance factor.

$$t_t = \frac{L_t}{60K\sqrt{S_o}} = \frac{L_t}{60V_t} \quad \text{Equation 6-4}$$

Where:

- $t_t$  = channelized flow time (travel time, min)
- $L_t$  = waterway length (ft)
- $S_o$  = waterway slope (ft/ft)
- $V_t$  = travel time velocity (ft/sec) =  $K\sqrt{S_o}$
- $K$  = NRCS conveyance factor (see Table 6-2).

**Table 6-2. NRCS Conveyance factors, K**

Type of Land Surface	Conveyance Factor, K
Heavy meadow	2.5
Tillage/field	5
Short pasture and lawns	7
Nearly bare ground	10
Grassed waterway	15
Paved areas and shallow paved swales	20

The time of concentration,  $t_c$ , is the sum of the initial (overland) flow time,  $t_i$ , and the channelized flow time,  $t_t$ , as per Equation 6-2.

### 2.4.3 First Design Point Time of Concentration in Urban Catchments

Equation 6-4 was solely determined by the waterway characteristics and using a set of empirical formulas. A calibration study between the Rational Method and the Colorado Urban Hydrograph Procedure (CUHP) suggests that the time of concentration shall be the lesser of the values calculated by Equation 6-2 and Equation 6-5 (Guo and Urbonas 2013).

$$t_c = (18 - 15i) + \frac{L_t}{60(24i + 12)\sqrt{S_o}} \quad \text{Equation 6-5}$$

Where:

- $t_c$  = minimum time of concentration for first design point when less than  $t_c$  from Equation 6-1.
- $L_t$  = length of flow path (ft)
- $i$  = imperviousness (expressed as a decimal)
- $S_o$  = slope of flow path (ft/ft).

Equation 6-5 is the regional time of concentration that warrants the best agreement on peak flow predictions between the Rational Method and CUHP. It was developed using the UDFCD database that includes 295 sample urban catchments under 2-, 5-, 10-, 50, and 100-yr storm events (MacKenzie 2010). It suggests that both initial flow time and channelized flow velocity are directly related to the catchment's imperviousness (Guo and MacKenzie 2013).

The first design point is defined as a node where surface runoff enters the storm drain system. For example, all inlets are "first design points" because inlets are designed to accept flow into the storm drain.

Typically, but not always, Equation 6-5 will result in a lesser time of concentration at the first design point and will govern in an urbanized watershed. For subsequent design points, add the travel time for each relevant segment downstream.

### 2.4.4 Minimum Time of Concentration

Use a minimum  $t_c$  value of 5 minutes for urbanized areas and a minimum  $t_c$  value of 10 minutes for areas that are not considered urban. Use minimum values even when calculations result in a lesser time of concentration.

### 2.4.5 Common Errors in Calculating Time of Concentration

A common mistake in urbanized areas is to assume travel velocities that are too slow. Another common error is to not check the runoff peak resulting from only part of the catchment. Sometimes a lower portion of the catchment or a highly impervious area produces a larger peak than that computed for the whole catchment. This error is most often encountered when the catchment is long or the upper portion contains grassy open land and the lower portion is more developed.

## 2.5 Rainfall Intensity

The calculated rainfall intensity,  $I$ , is the average rainfall rate in inches per hour for the period of maximum rainfall having a duration equal to the time of concentration.

After the design storm recurrence frequency has been selected, a graph should be made showing rainfall intensity versus time. The procedure for obtaining the local data and plotting such a graph is explained and illustrated in the *Rainfall* chapter of the USDCM. The UD-Rain Excel workbook can also be used for calculating the intensity. This workbook is available for download at [www.udfcd.org](http://www.udfcd.org).



**Photograph 6-2.** Urbanization (impervious area) increases runoff volumes, peak discharges, frequency of runoff, and receiving stream degradation.

### 2.5.1 Runoff Coefficient

Each part of a watershed can be considered as either pervious or impervious. The pervious part is the area where water can readily infiltrate into the ground. The impervious part is the area that does not readily allow water to infiltrate into the ground, such as areas that are paved or covered with buildings and sidewalks or compacted unvegetated soils. In urban hydrology, the percentage of pervious and impervious land is important. Urbanization increases impervious area causing rainfall-runoff relationships to change significantly. In the absence of stormwater management methods such as low impact development and green infrastructure, the total runoff volume increases, the time to the runoff peak rate decreases, and the peak runoff rate increases.

When analyzing a watershed for planning or design purposes, the probable future percent of impervious area must be estimated. A complete tabulation of recommended values of the total percent of imperviousness is provided in Table 6-3.

The runoff coefficient,  $C$ , represents the integrated effects of infiltration, evaporation, retention, and interception, all of which affect the volume of runoff. The determination of  $C$  requires judgment based on experience and understanding on the part of the engineer.

Volume-based runoff coefficients were derived to establish the optimal consistency between CUHP and the Rational Method for peak flow predictions (Guo, 2013). Using the percentage imperviousness, the equations in Table 6-4 can be used to calculate the runoff coefficients for hydrologic soil groups A, B, and C/D for various storm return periods.

**Table 6-3. Recommended percentage imperviousness values**

Land Use or Surface Characteristics	Percentage Imperviousness (%)
<b>Business:</b>	
Downtown Areas	95
Suburban Areas	75
<b>Residential:</b>	
Single-family	
2.5 acres or larger	12
0.75 – 2.5 acres	20
0.25 – 0.75 acres	30
0.25 acres or less	45
Apartments	75
<b>Industrial:</b>	
Light areas	80
Heavy areas	90
<b>Parks, cemeteries</b>	10
<b>Playgrounds</b>	25
<b>Schools</b>	55
<b>Railroad yard areas</b>	50
<b>Undeveloped Areas:</b>	
Historic flow analysis	2
Greenbelts, agricultural	2
Off-site flow analysis (when land use not defined)	45
<b>Streets:</b>	
Paved	100
Gravel (packed)	40
Drive and walks	90
Roofs	90
Lawns, sandy soil	2
Lawns, clayey soil	2

**Table 6-4. Runoff coefficient equations based on NRCS soil group and storm return period**

NRCS Soil Group	Storm Return Period					
	2-Year	5-Year	10-Year	25-Year	50-Year	100-Year
A	$C_A = 0.89i$	$C_A = 0.93i$	$C_A = 0.94i$	$C_A = 0.944i$	$C_A = 0.95i$	$C_A = 0.81i + 0.154$
B	$C_B = 0.89i$	$C_B = 0.93i$	$C_B = 0.81i + 0.125$	$C_B = 0.70i + 0.23$	$C_B = 0.59i + 0.364$	$C_B = 0.49i + 0.454$
C/D	$C_{C/D} = 0.89i$	$C_{C/D} = 0.87i + 0.052$	$C_{C/D} = 0.74i + 0.2$	$C_{C/D} = 0.64i + 0.31$	$C_{C/D} = 0.54i + 0.418$	$C_{C/D} = 0.45i + 0.508$

Where:

$i$  = % imperviousness (expressed as a decimal)

$C_A$  = Runoff coefficient for Natural Resources Conservation Service (NRCS) HSG A soils

$C_B$  = Runoff coefficient for NRCS HSG B soils

$C_{C/D}$  = Runoff coefficient for NRCS HSG C and D soils.

The values for various catchment imperviousness and storm return periods are presented graphically in Figures 6-1 through 6-3, and are tabulated in Table 6-5. These coefficients were developed for the Denver region to work in conjunction with the time of concentration recommendations in Section 2.4. Use of these coefficients and this procedure outside of the semi-arid climate found in the Denver region may not be valid. The UD-Rational Excel workbook performs all the needed calculations to find the runoff coefficient given the soil type and imperviousness and the reader may want to take advantage of this macro-enabled Excel workbook that is available for download from the UDFCD's website [www.udfcd.org](http://www.udfcd.org).

See Examples 7.1 and 7.2 that illustrate the Rational Method.

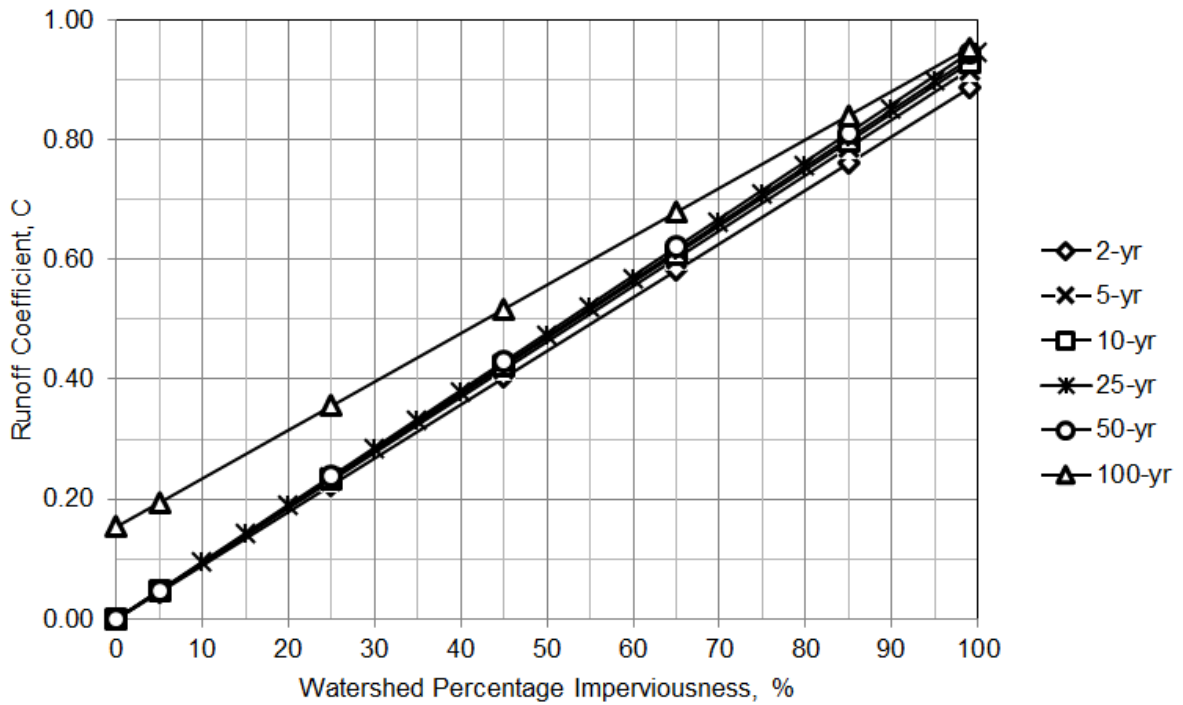


Table 6-5. Runoff coefficients, *c*

Total or Effective % Imperviousness	NRCS Hydrologic Soil Group A					
	2-yr	5-yr	10-yr	25-yr	50-yr	100-yr
2%	0.02	0.02	0.02	0.02	0.02	0.17
5%	0.04	0.05	0.05	0.05	0.05	0.19
10%	0.09	0.09	0.09	0.09	0.1	0.23
15%	0.13	0.14	0.14	0.14	0.14	0.28
20%	0.18	0.19	0.19	0.19	0.19	0.32
25%	0.22	0.23	0.24	0.24	0.24	0.36
30%	0.27	0.28	0.28	0.28	0.29	0.4
35%	0.31	0.33	0.33	0.33	0.33	0.44
40%	0.36	0.37	0.38	0.38	0.38	0.48
45%	0.4	0.42	0.42	0.42	0.43	0.52
50%	0.45	0.47	0.47	0.47	0.48	0.56
55%	0.49	0.51	0.52	0.52	0.52	0.6
60%	0.53	0.56	0.56	0.57	0.57	0.64
65%	0.58	0.6	0.61	0.61	0.62	0.68
70%	0.62	0.65	0.66	0.66	0.67	0.72
75%	0.67	0.7	0.71	0.71	0.71	0.76
80%	0.71	0.74	0.75	0.76	0.76	0.8
85%	0.76	0.79	0.8	0.8	0.81	0.84
90%	0.8	0.84	0.85	0.85	0.86	0.88
95%	0.85	0.88	0.89	0.9	0.9	0.92
100%	0.89	0.93	0.94	0.94	0.95	0.96
Total or Effective % Imperviousness	NRCS Hydrologic Soil Group B					
2%	0.02	0.02	0.14	0.24	0.38	0.46
5%	0.04	0.05	0.17	0.27	0.39	0.48
10%	0.09	0.09	0.21	0.3	0.42	0.5
15%	0.13	0.14	0.25	0.34	0.45	0.53
20%	0.18	0.19	0.29	0.37	0.48	0.55
25%	0.22	0.23	0.33	0.41	0.51	0.58
30%	0.27	0.28	0.37	0.44	0.54	0.6
35%	0.31	0.33	0.41	0.48	0.57	0.63
40%	0.36	0.37	0.45	0.51	0.6	0.65
45%	0.4	0.42	0.49	0.55	0.63	0.67
50%	0.45	0.47	0.53	0.58	0.66	0.7
55%	0.49	0.51	0.57	0.62	0.69	0.72
60%	0.53	0.56	0.61	0.65	0.72	0.75
65%	0.58	0.6	0.65	0.69	0.75	0.77
70%	0.62	0.65	0.69	0.72	0.78	0.8
75%	0.67	0.7	0.73	0.76	0.81	0.82
80%	0.71	0.74	0.77	0.79	0.84	0.85
85%	0.76	0.79	0.81	0.83	0.87	0.87
90%	0.8	0.84	0.85	0.86	0.89	0.9
95%	0.85	0.88	0.89	0.9	0.92	0.92
100%	0.89	0.93	0.94	0.94	0.95	0.94

**Table 6-5. Runoff coefficients, *c* (continued)**

Total or Effective % Imperviousness	NRCS Hydrologic Soil Groups C and D					
	2-yr	5-yr	10-yr	25-yr	50-yr	100-yr
2%	0.02	0.07	0.22	0.32	0.43	0.52
5%	0.04	0.1	0.24	0.34	0.45	0.53
10%	0.09	0.14	0.27	0.37	0.47	0.55
15%	0.13	0.18	0.31	0.41	0.5	0.58
20%	0.18	0.23	0.35	0.44	0.53	0.6
25%	0.22	0.27	0.39	0.47	0.55	0.62
30%	0.27	0.31	0.42	0.5	0.58	0.64
35%	0.31	0.36	0.46	0.53	0.61	0.67
40%	0.36	0.4	0.5	0.57	0.63	0.69
45%	0.4	0.44	0.53	0.6	0.66	0.71
50%	0.45	0.49	0.57	0.63	0.69	0.73
55%	0.49	0.53	0.61	0.66	0.72	0.76
60%	0.53	0.57	0.64	0.69	0.74	0.78
65%	0.58	0.62	0.68	0.73	0.77	0.8
70%	0.62	0.66	0.72	0.76	0.8	0.82
75%	0.67	0.7	0.76	0.79	0.82	0.85
80%	0.71	0.75	0.79	0.82	0.85	0.87
85%	0.76	0.79	0.83	0.85	0.88	0.89
90%	0.8	0.83	0.87	0.89	0.9	0.91
95%	0.85	0.88	0.9	0.92	0.93	0.94
100%	0.89	0.92	0.94	0.95	0.96	0.96



**Figure 6-1. Runoff coefficient vs. watershed imperviousness NRCS HSG A**

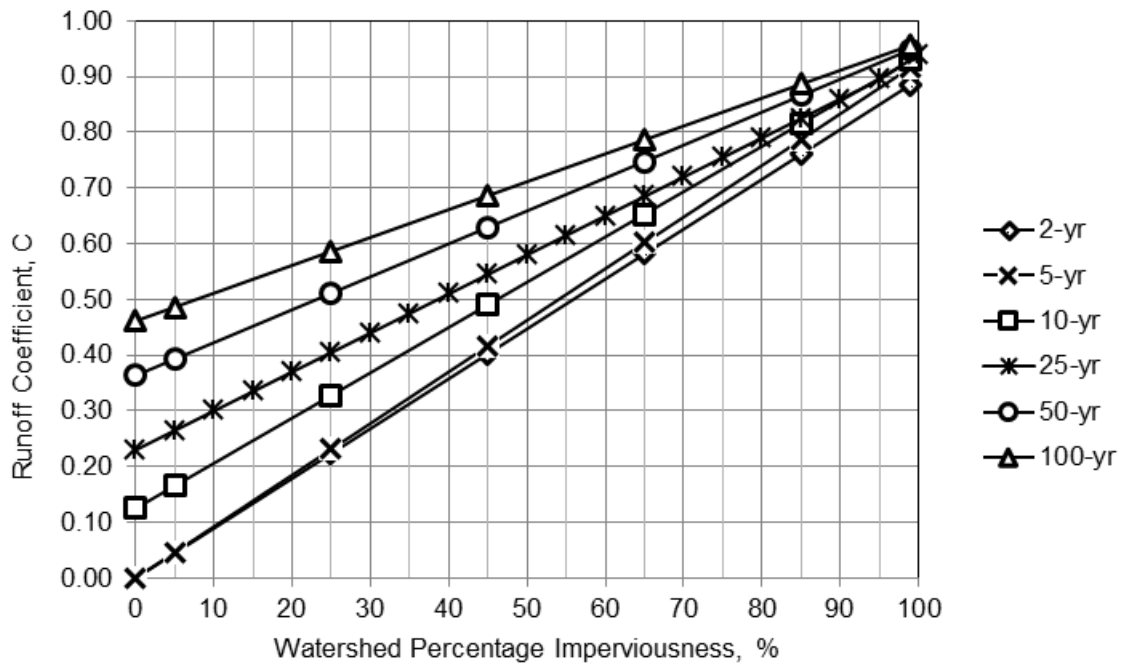


Figure 6-2. Runoff coefficient vs. watershed imperviousness NRCS HSG B

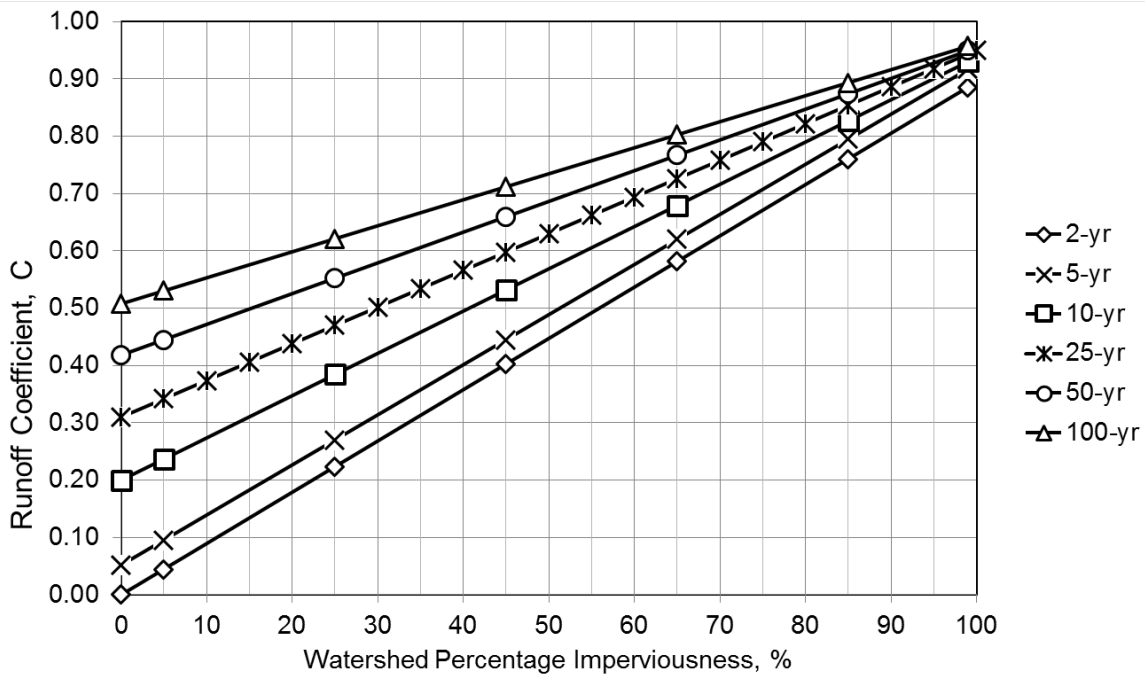


Figure 6-3. Runoff coefficient vs. watershed imperviousness NRCS HSG C and D

## 3.0 Colorado Urban Hydrograph Procedure

### 3.1 Background

The Colorado Urban Hydrograph Procedure (CUHP) is a method of hydrologic analysis based upon the unit hydrograph principle. A unit hydrograph is defined as the hydrograph of one inch of direct runoff from the tributary area resulting from a storm of a given duration. The unit hydrograph thus represents the integrated effects of factors such as tributary area, shape, street pattern, channel capacities, and street and land slopes. The basic premise of the unit hydrograph is that individual hydrographs resulting from the successive increments of excess rainfall that occur throughout a storm period will be proportional in discharge throughout their runoff period. Thus, the hydrograph of total storm discharge is obtained by summing the ordinates of the individual sub-hydrographs.

CUHP has been developed and calibrated using rainfall-runoff data collected in Colorado (mostly in the Denver/Boulder metropolitan area). This section provides a general background in the use of the computer version of CUHP to carry out stormwater runoff calculations. A detailed description of the CUHP method and the assumptions and equations used, including a hand calculation example, are provided in the CUHP User Manual. The latest version of the CUHP 2005 macro-enabled Excel workbook and User Manual are available for download from [www.udfcd.org](http://www.udfcd.org).

### 3.2 Effective Rainfall for CUHP

Effective rainfall is that portion of precipitation during a storm event that runs off the land to streams. Those portions of precipitation that do not reach a stream are called abstractions and include interception by vegetation, evaporation, infiltration, storage in all surface depressions, and extended duration surface retention. The total design rainfall depth for use with CUHP should be obtained from the *Rainfall* chapter of the USDCM. This chapter illustrates a method for estimating the amount of rainfall that actually becomes surface runoff whenever a design rainstorm is used.

#### 3.2.1 Pervious-Impervious Areas

As described in Section 2.5.1, the urban landscape is comprised of pervious and impervious surfaces. The degree of imperviousness is the primary variable that affects the volumes and rates of runoff calculated using CUHP. When analyzing a watershed for design purposes, the probable future percent of impervious area must first be estimated. A complete tabulation of recommended values of total percentage imperviousness is provided in Table 6-3 and Figures 6-1 through 6-3. References to impervious area and all calculations in this chapter are based on the input of total impervious areas. The pervious-impervious area relationship can be further refined for use in CUHP as follows:

- **DCIA:** Impervious area portion directly connected to the drainage system.
- **UIA:** Impervious area portion that drains onto or across pervious surfaces.
- **RPA:** The portion of pervious area receiving runoff from impervious portions.
- **SPA:** The separate pervious area portion not receiving runoff from impervious surfaces.

This further refinement is explained in more detail in the CUHP User Manual and in Chapter 3 of the USDCM Volume 3.

### 3.2.2 Depression Losses

Rainwater that is collected and held in small depressions and does not become part of the general surface runoff is called depression loss. Most of this water eventually infiltrates or evaporates. Depression losses also include water intercepted by trees, bushes, other vegetation, and all other surfaces. The CUHP method requires numerical values of depression loss as inputs to calculate the effective rainfall. Table 6-6 can be used as a guide in estimating the amount of depression (retention) losses to be used with CUHP.

**Table 6-6. Typical depression losses for various land covers**

(All values in inches for use with the CUHP.)

Land Cover	Range in Depression (Retention) Losses	Recommended
<b>Impervious:</b>		
Large paved areas	0.05 - 0.15	0.1
Roofs-flat	0.1 - 0.3	0.1
Roofs-sloped	0.05 - 0.1	0.05
<b>Pervious:</b>		
Lawn grass	0.2 - 0.5	0.35
Wooded areas and open fields	0.2 - 0.6	0.4

When an area is analyzed for depression losses, the pervious and impervious loss values for all parts of the watershed must be considered and accumulated in proportion to the percent of aerial coverage for each type of surface.

### 3.2.3 Infiltration

Flow of water into the soil surface is called infiltration. In urban hydrology much of the infiltration occurs on areas covered with grass. Urbanization can increase or decrease the total amount of infiltration depending on how the runoff is managed, historic use of the area and other factors.

Soil type is the most important factor in determining the infiltration rate. When the soil has a large percentage of well-graded fines, the infiltration rate is low. In some cases of extremely tight soil there may be, from a practical standpoint, essentially no infiltration. If the soil has several layers or horizons, the least permeable layer near the surface will control the maximum infiltration rate. The soil cover also plays an important role in determining the infiltration rate. Vegetation, lawn grass in particular, tends to increase infiltration by loosening the soil near the surface. Other factors affecting infiltration rates include slope of land, temperature, quality of water, age of lawn, and soil compaction. Of these, CUHP considers only the slope.

As rainfall continues, the infiltration rate decreases. When rainfall occurs on an area that has little antecedent moisture and the ground is dry, the infiltration rate can be much higher than it is with high antecedent moisture resulting from previous storms or land irrigation such as lawn watering. Although antecedent precipitation is important when calculating runoff from smaller storms in non-urbanized areas, the runoff data from urbanized watersheds indicates that antecedent precipitation has a smaller effect on runoff peaks and volumes in the urbanized portions of UDFCD.

There are many infiltration models in use by hydrologists. These models vary significantly in complexity. Because of the climatic condition in the semi-arid region and because runoff from urban

watersheds is not very sensitive to infiltration refinements, the infiltration model proposed by Horton was found to provide a good balance between simplicity and reasonable physical description of the infiltration process for use in CUHP. Horton's infiltration model is described by Equation 6-6.

$$f = f_o + (f_i - f_o) e^{-at} \quad \text{Equation 6-6}$$

Where:

$f$  = infiltration rate at any given time  $t$  from start of rainfall (in/hr)

$f_o$  = final infiltration rate (in/hr)

$f_i$  = initial infiltration rate (in/hr)

$e$  = natural logarithm base

$a$  = decay coefficient (1/second)

$t$  = time (seconds).

In developing Equation 6-6, Horton observed that infiltration is high early in the storm and eventually decays to a steady state constant value as the pores in the soil become saturated. The coefficients and initial and final infiltration values are site specific and depend on the soils and vegetative cover. It is possible to develop these values for a specific site if sufficient rainfall-runoff observations are made. However, such an approach is rarely practical.

Since 1977, UDFCD has analyzed a considerable amount of rainfall-runoff data. On the basis of this analysis, the values in Table 6-7 are recommended for use within UDFCD with CUHP. The NRCS Hydrologic Soil Groups C and D occur most frequently within UDFCD; however, areas of NRCS Group A and B soils also exist. Consult NRCS soil surveys for appropriate soil classifications.

**Table 6-7. Recommended Horton's equation parameters**

NRCS Hydrologic Soil Group	Infiltration (inches per hour)		Decay Coefficient— $a$
	Initial— $f_i$	Final— $f_o$	
A	5.0	1.0	0.0007
B	4.5	0.6	0.0018
C	3.0	0.5	0.0018
D	3.0	0.5	0.0018

To calculate the maximum infiltration depths that may occur at each time increment, it is necessary to integrate Equation 6-6 and calculate the values for each time increment. Very little accuracy is lost if, instead of integrating Equation 6-6, the infiltration rate is calculated at the center of each time increment. This "central" value can then be multiplied by the unit time increment to estimate the infiltration depth. Although Table 6-7 provides recommended values for various Horton equation parameters, these recommendations are being made specifically for the urbanized or urbanizing watersheds in the Denver metropolitan area and may not be valid in different meteorological and climatic regions.

### 3.3 CUHP Parameter Selection

#### 3.3.1 Rainfall

The CUHP 2005 Excel workbook requires the input of a design storm, either as a user-defined hyetograph or as a program generated hyetograph using 1-hour and 6-hour rainfall depths. The CUHP program generates a hyetograph using the 1-hour depth and the standard 2-hour temporal distribution recommended in the *Rainfall* chapter of the USDCM. In addition, the program will also generate a 6-hour storm distribution with area corrections accounted for in cases where larger watersheds are studied.

#### 3.3.2 Catchment Description

The following catchment parameters are required for the program to generate a unit and storm hydrograph.

- **Area:** Catchment area in square miles. See Table 6-1 for catchment size limits. Typically a 5-minute unit hydrograph is used in CUHP. However, for catchments smaller than 90 acres, using a 1-minute unit hydrograph is recommended particularly if significant differences are found between the “excess precipitation” and “runoff hydrograph” volumes listed in the summary output. For very small catchments (i.e. smaller than 10 acres), especially those with high imperviousness, the 1-minute unit hydrograph will be needed to preserve runoff volume integrity.
- **Length:** The length in miles from the downstream design point of the catchment or subcatchment along the main flow path to the furthest point on its respective catchment or subcatchment boundary. When a catchment is subdivided into a series of subcatchments, the subcatchment length used shall include the distance required for runoff to reach the major drainageway from the farthest point in the subcatchment.
- **Length to Centroid:** Distance in miles from the design point of the catchment or subcatchment along the main drainageway path to its respective catchment or subcatchment centroid.
- **Slope:** The length-weighted, corrected average slope of the catchment in feet per foot.
  - There are natural processes at work that limit the time to peak of a unit hydrograph as a natural stream or vegetated channel becomes steeper. To account for this phenomenon, it is recommended that the slope used in CUHP for streams and vegetated channels be adjusted using Figure 6-4.
  - When a riprap channel is evaluated, use the measured (i.e., uncorrected) average channel invert slope.
  - In concrete-lined channels and buried conduits, the velocities can be very high. For this reason, it is recommended that the average ground slope (i.e., not flow-line slope) be used where concrete-lined channels and/or storm drains dominate the watershed drainageways. There is no correction factor or upper limit recommended to the slope for concrete-lined channels and buried conduits.

Where the flow-line slope varies along the channel, calculate a weighted sub-catchment slope for use with CUHP. Do this by first segmenting the major drainageway into reaches having similar longitudinal slopes. Then calculate the weighted slope using the Equation 6-7.

$$S = \left[ \frac{L_1 S_1^{0.24} + L_2 S_2^{0.24} + \dots + L_n S_n^{0.24}}{L_1 + L_2 + L_3 \dots L_n} \right]^{4.17} \quad \text{Equation 6-7}$$

Where:

$S$  = weighted basin waterway slopes in ft/ft

$S_1, S_2, \dots, S_n$  = slopes of individual reaches in ft/ft (after adjustments using Figure 6-4)

$L_1, L_2, \dots, L_n$  = lengths of corresponding reaches in ft.

- **Percent Impervious:** The portion of the catchment's total surface area that is impervious, expressed as a percent value between 0 and 100. (See Section 3.2.1 for more details.)
- **Maximum Pervious Depression Storage:** Maximum depression storage on pervious surfaces in inches. (See Table 6-6).
- **Maximum Impervious Depression Storage:** Maximum depression storage on impervious surfaces in inches. (See Table 6-6).
- **Initial Infiltration Rate:** Initial infiltration rate for pervious surfaces in the catchment in inches per hour. If this entry is used by itself, it will be used as a constant infiltration rate throughout the storm. (See Table 6-7).
- **Horton's Decay Coefficient:** Exponential decay coefficient in Horton's equation in "per second" units. (See Table 6-7).
- **Final Infiltration Rate:** Final infiltration rate in Horton's equation in inches per hour. (See Table 6-7).

The following catchment parameters are optional inputs and are available to the user to account for the effects of directly connected/disconnected impervious areas:

- **DCIA Level:** Specifies the directly connected impervious area (DCIA) level of practice as defined in the Structural BMPs chapter in Volume 3 of the USDCM. The user may specify 0, 1 or 2 for the level of DCIA to model.
- **Directly Connected Impervious Fraction:** Defines the fraction of the total impervious area directly connected to the drainage system. Values range from 0.01 to 1.0.
- **Receiving Pervious Fraction:** Defines the fraction of total pervious area receiving runoff from the "disconnected" impervious areas. Values range from 0.01 to 1.0.

To assist in the determination of the time to peak and peak runoff for the unit hydrograph, the program computes the coefficients  $C_T$ ,  $C_i$  and  $C_p$ ; however, override values for these parameters can also be specified by the user as an option. The unit hydrograph is developed by the computer using the algorithm described in the CUHP 2005 User Manual.

- **$C_T$ :** An unmodified time to peak coefficient that relates the total imperviousness of a catchment to the time to peak.



- $C_t$ : Area-adjusted time to peak coefficient obtained by applying an area correction to  $C_T$
- $C_p$ : Peak runoff rate coefficient determined from  $C_t$  and the peaking parameter,  $P$ .

The shaping of the unit hydrograph also relies on proportioning the widths at 50% and 75% of the unit hydrograph peak. The proportioning is based on 0.35 of the width at 50% of peak being ahead of the “time to peak” and 0.45 of the width at 75% of peak being ahead of the “time to peak.” These proportioning factors were selected after observing a number of unit hydrographs derived from the rainfall-runoff data collected by the USGS for UDFCD. It is possible for the user to override the unit hydrograph widths and the proportioning of these widths built into the program. For drainage and flood studies within UDFCD, the program values should be used. If the user has derived unit hydrographs from reliable rainfall-runoff data for a study catchment and can develop a “calibrated” unit hydrograph for this catchment, this option permits reshaping the unit hydrograph accordingly.

### 3.3.3 Catchment Delineation Criteria

UDFCD recommends an average catchment size of approximately 100 acres for master planning purposes. Catchments larger than 5 square miles should be subdivided into subcatchments and individual subcatchment storm hydrographs should be routed downstream using appropriate channel routing procedures such as the EPA’s SWMM model. The routed hydrographs are then added to develop a single composite storm hydrograph. See Table 6-1 for a description of catchment size limitations for CUHP.

The catchment shape can have a profound effect on the final results and, in some instances, can result in underestimates of peak flows. Experience with the 1982 version of CUHP has shown that, whenever catchment length is increased faster than its area, the storm hydrograph peak will tend to decrease disproportionately. Although hydrologic routing is an integral part of runoff analysis, the data used to develop CUHP are insufficient to say that the observed CUHP response with disproportionately increasing basin length is valid. For this reason, it is recommended to subdivide irregularly shaped or very long catchments (i.e., catchment length to width ratio of four or more) into more regularly shaped subcatchments. A composite catchment storm hydrograph can be developed using appropriate routing and by adding the individual subcatchment storm hydrographs.

### 3.3.4 Combining and Routing Subcatchment CUHP Hydrographs

When analyzing a number of subcatchments, it is necessary to combine and route the runoff hydrographs subcatchment to determine the flows and volumes throughout the system. The CUHP 2005 software provides input parameters that identify to which junction in EPA SWMM each subcatchment’s hydrograph is to be linked and to then generate an output file that SWMM recognizes as an external flow file. All of these and other features are covered in the CUHP 2005 User Manual.

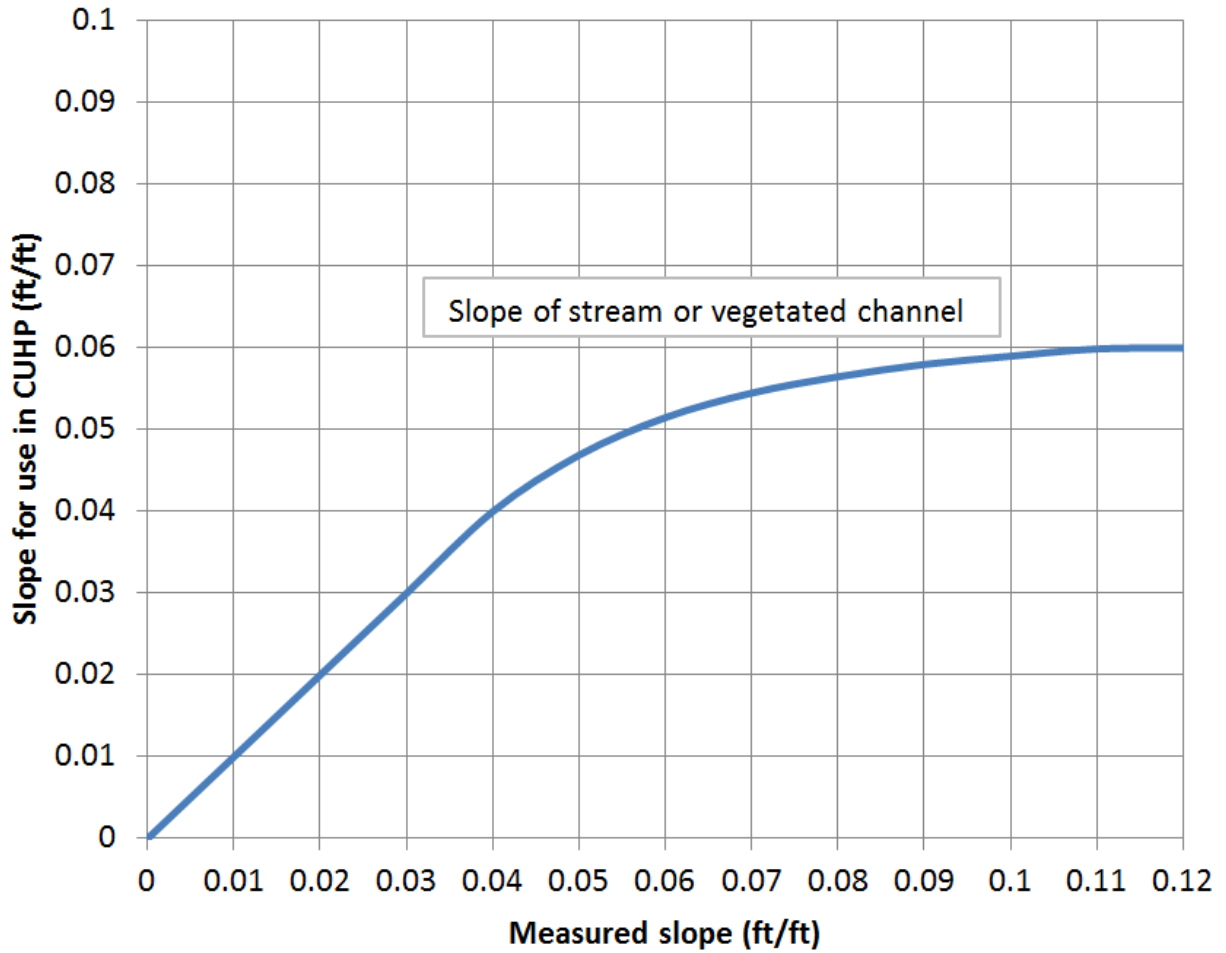


Figure 6-4. Slope correction for streams and vegetated channels

## 4.0 EPA SWMM And Hydrograph Routing

The Environmental Protection Agency's (EPA's) Stormwater Management Model (SWMM) 5 is a computer model that is used to generate surface runoff hydrographs from subcatchments and then route and combine these hydrographs. The procedure described here is limited to the routing of hydrographs generated using CUHP software. Originally this was done using UDSWM, a modified version of EPA SWMM runoff calculations designed to work with CUHP. In 2005, UDFCD adopted the use of EPA's SWMM 5.0 model and recommends its use for all future hydrology studies.

The purpose of the discussion of SWMM in this chapter is to provide general background on the use of the model with CUHP 2005 software to perform more complex stormwater runoff calculations using SWMM. Complete details about this model's use and specifics of data format are provided in the user manual for SWMM. That software, user manual, and other information about EPA's SWMM may be downloaded from <http://www2.epa.gov/water-research/storm-water-management-model-swmm>.

### 4.1 Software Description

SWMM represents a watershed by an aggregate of idealized runoff planes, channels, gutters, pipes and specialized units such as storage nodes, outlets, pumps, etc. The program can accept rainfall hyetographs and make a step-by-step accounting of rainfall infiltration losses in pervious areas, surface retention, overland flow, and gutter flow leading to the calculation of hydrographs. However, this portion of the model is normally not used by UDFCD because the resulting peak flows and volumes of runoff would not be calibrated to UDFCD regional rainfall-runoff observations the way CUHP storm hydrographs are. Instead, the calculation of hydrographs for each subcatchment is carried out using the CUHP software. If the user wants to use SWMM to calculate runoff, the model must be calibrated against the CUHP calculations for each subcatchment being studied.

After the CUHP 2005 software is used to calculate hydrographs from a number of subcatchments, the resulting hydrographs from these subcatchments can be combined and routed through a series of links (i.e., channels, gutters, pipes, dummy links, etc.) and nodes (i.e., junctures, storage, diversion, etc.) to compute the resultant hydrographs at any number of design points within the watershed.

#### 4.1.1 Surface Flows and Flow Routing Features

Stormwater runoff hydrographs generated using CUHP 2005 can be routed through a system of stormwater conveyance, diversion, storage, etc. elements of a complex urban watershed. In setting up the SWMM model, it is critical that overflow links for storm sewers and diversion junctions are provided in the model. The combination of these allows the user to model flows accurately when pipes and/or channels that do not have the capacity to convey higher flows, at which time the excess flows are diverted to the overflow channels. This method avoids "choking" of the flow and errors in the calculated peak flow values downstream are prevented.

There are several types of conveyance elements that one can select from a menu in SWMM. One element that is now available, that was not available in older versions, is a user-defined irregular channel cross-section, similar to the way cross-sections are defined in HEC-RAS. This makes the model very flexible in modeling natural waterways and composite man-made channels. For a complete description of the routing elements and junction types available for modeling, see the SWMM User's Manual published by EPA and available from their website mentioned earlier.

### 4.1.2 Flow Routing Method of Choice

UDFCD recommends the use of kinematic wave routing as the “routing” option in SWMM for planning purposes. Flood flows are generally dominated by kinematic waves (USACE 1993). Dynamic wave routing for most projects, does not improve the accuracy of the runoff estimates, and can be much more difficult to implement because it requires more information to describe the entire flow routing system. Additionally, it has tendencies to become unstable when modeling the more complex elements and/or junctions. Much of the required detail may not even be available during the planning phase (e.g., location of all drop structures and their crest and toe elevations for which a node must be defined in the model).

The use of dynamic wave routing is appropriate when inertial and pressure forces are important and when evaluating complex existing elements of a larger system. It is an option that can also offer some advantages in final design and its evaluation, as it provides hydraulic grade lines and accounts for backwater effects.

## 4.2 Data Preparation for the SWMM Software

Use of SWMM requires three basic steps:

**Step 1:** Identify and define the geometries of the watershed, subcatchments, and conveyance/storage elements.

**Step 2:** Estimates of roughness coefficients and functional/tabular relationships for storage and other special elements.

**Step 3:** Prepare input data for the model.

### 4.2.1 Step 1: Method of Discretization

Discretization is a procedure for the mathematical abstraction of the watershed and of the physical drainage system. Discretization begins with the identification of drainage area boundaries, the location of storm drains, streets, and channels, and the selection of those routing elements to be included in the system. For the computation of hydrographs, the watershed may be conceptually represented by a network of hydraulic elements (i.e., subcatchments, gutters, pipes, etc.). Hydraulic properties of each element are then characterized by various parameters such as size, slope, and roughness coefficient.

### Discretizing large catchments into smaller ones:

Discretizing large catchments into smaller ones often results in increased unit discharges. The following recommendations can help eliminate the effect of the increase to provide more realistic hydraulic routing through the conveyance network in the EPA SWMM:

- Carefully estimate the effective longitudinal channel slope instead of relying on the elevations at the two ends of each routing element. If there are drop structures or other forms of vertical offsets in the channel reach, the effective channel slope between drops should be used rather than an overall reach slope between endpoints.
- Select the irregular natural channel option in the SWMM conduit cross-section editor to accurately represent actual channel cross-sections rather than selecting general geometric channels. This will ensure a more accurate wetted perimeter.
- Use appropriate Manning's  $n$  values that are reflective of the nuances in channel geometry and other flow controls along its reaches, namely those recommended in Section 7.2.3 of the *Open Channels* Chapter of the USDCM by following these guidelines:
  - For lined channels and pipes, increase Manning's  $n$  value by 25% over what would normally be used for the design as described in Section 4.2.2 below.
  - For grass-lined, riprap-lined and natural channels use the higher range of the values for the appropriate type of channel reach as recommended in Table B.2. Manning's Roughness Coefficients for Various Boundaries of the FHWA publication HDS-4, Introduction to Highway Hydraulics.
  - Whenever HEC-RAS sections are available, use the roughness coefficients for the main channel and overbanks from those studies unless the values obtained from item 3.b above are higher.

## 4.2.2 Step 2: Estimate Coefficients and Functional/Tabular Characteristic of Storage and Outlets

For hydrologic routing through conveyance elements such as pipes, gutters, and channels, the resistance (Manning's  $n$ ) coefficients should not necessarily be the same as those used in performing hydraulic design calculations. As a general rule, it was found that increasing the "typical" values of Manning's  $n$  by approximately 25 percent was appropriate when using UDSWM in the past and should be appropriate for use in SWMM as well. Thus, if a pipe is estimated to have  $n = 0.013$  for hydraulic calculations, it is appropriate to use  $n = 0.016$  in SWMM.

When modeling the hydrologic routing of natural streams, grass-lined channels, or riprap-lined channels in Colorado, it is recommended that Manning's  $n$  be estimated for SWMM using Equation 6-8 (Jarrett 1984 and 1985).

$$n = 0.393 S^{0.38} R^{-0.16} \quad \text{Equation 6-8}$$

Where:

$n$  = Manning's roughness coefficient

$S$  = friction slope (ft/ft)  
 $R$  = hydraulic radius (ft).

To estimate the hydraulic radius of a natural, grass-lined, or riprap-lined channel for Equation 6-8, it is suggested that one-half of the estimated hydrograph peak flow be used to account for the variable depth of flow during a storm event.

SWMM does not have built-in shapes that define geometries of gutters or streets. The user can use the irregular shape option to define the shape of the gutter and street. For storage junctions, the user can define relationships such as stage vs. storage-surface area using mathematical functions or tables, which can be generated using the UD-FSD or UD-Detention Excel workbooks. For storage outlets or downstream outfalls, the user can use tables or functions to define their stage-discharge characteristics. As an alternative, the user can define geometries and characteristics for weirs and orifices and let the program calculate the functional relationships. Use of the weirs can sometimes be particularly troublesome when the dynamic wave routing option is used.

### 4.2.3 Step 3: Preparation of Data for Computer Input

The major preparation effort is forming a tree structure of all the runoff and conveyance elements and dividing the watershed into subcatchments. The conveyance elements network is developed using a watershed map, subdivision plans, and "as-built" drawings of the drainage system. Pipes with little or no backwater effects, channels, reservoirs, or flow dividers are usually designated as conveyance elements for computation by SWMM. Once the conveyance element system is set and labeled, CUHP 2005 is used to generate an output text file that contains runoff hydrographs for all subcatchments. This file is formatted for use in SWMM as an external "inflow interface file" and the hydrograph data is then routed by SWMM. The reader should study the SWMM User's Manual for complete details about data input preparation.

## 5.0 Other Hydrologic Methods

### 5.1 Published Hydrologic Information

UDFCD has prepared hydrologic studies for the majority of the major drainageways within UDFCD boundaries. These studies contain information regarding peak flow and runoff volume from the 2-year through 100-year storm events for numerous design points within the watershed. They also contain information regarding watershed and subcatchment boundaries, soil types, percentage imperviousness, and rainfall. The studies are available at [www.udfcd.org](http://www.udfcd.org). When published flow values are available from UDFCD for any waterway of interest, these values should be used for design unless there are compelling reasons to modify the published values.

### 5.2 Statistical Methods

Statistical analysis of measured streamflow data is also an acceptable means of hydrologic analysis in certain situations outside the UDFCD boundary. Statistical analysis should be limited to streams with a long period of flow data (30 years as a recommended minimum) where there have been no significant changes in land use in the tributary watershed during the period of the flow record (stationarity). It should be recognized that there is no generally accepted and widely used way to extrapolate calculated flow from a statistical analysis to estimate the flow for expected future watershed development conditions.

## 6.0 Software

UDFCD provides the following freeware to help with the calculations and protocols in the USDCM. All of these can be found at [www.udfcd.org](http://www.udfcd.org).

The Colorado Urban Hydrograph Procedure has been programmed as a macro-enabled Excel workbook, titled CUHP 2005.

An Excel workbook has been prepared to facilitate runoff calculations using the Rational Method, namely, UD-Rational (Guo 1995). Inputs needed include catchment area, runoff coefficient, 1-hour point rainfall depth, and flow reach characteristics (length, slope, and type of ground surface). The workbook then calculates the peak runoff flow rate in cfs.

Storm sewers may be designed using the Rational Method with the aid of the UD-Sewer software. This software will pre-size storm sewers using the same input mentioned for UD-Rational, except that it permits definition of existing sewer links and that it also checks to insure that the most critical portions of the catchment are being accounted for in sizing the sewers. After the sewers are sized, or for an existing system, it can be used to analyze the hydraulic and energy grade lines of the system and will generate a profile plot of the sewer, ground line, hydraulic grade line and energy grade line.

UD-Rain is an Excel workbook that helps the user find the rainfall depth-duration-frequency and intensity-duration-frequency curves for any region in Colorado based on site elevation. It also helps the user develop 2-hour design storm distributions for use with CUHP or other models based on the protocols described in the USDCM. It will generate design storm hyetographs for small catchments (i.e., < 5 sq. mi.) all the way up to ones that are 75 sq. mi. in size, using area correction factors for the latter.

The latest release of the EPA SWMM software is available for downloading from EPA's web site at <http://www2.epa.gov/water-research/storm-water-management-model-swmm>.

It is recommended that the users of these software packages check for updates on a regular basis. Corrections of discovered bugs and enhancements are constantly under development and are posted as they are completed.

## 7.0 Examples

### 7.1 Rational Method Example 1

Find the 100-year peak flow rate for a 60-acre catchment in an undeveloped grassland area located in Section 13, R65W, T1S. The upper 400 feet of the catchment is sloped at 2%, the lower 1,500 feet is grassed waterway that is sloped at 1%. The area has type C soils.

From Figure 5-6 of the *Rainfall* chapter, the 1-hour point precipitation value is 2.7 inches. From Table 6-3, in the category “Undeveloped Areas, historic flow analysis,” a percent impervious value of 2% (or 0.02) is selected.

Determine  $C_5$  from Table 6-4:

$$C_5 = 0.0087i + 0.052$$

$$C_5 = 0.0087(2) + 0.052$$

$$= 0.07$$

Determine  $t_i$  from Equation 6-3:

$$t_i = \frac{0.395(1.1 - C_5)\sqrt{L}}{S_o^{0.33}}$$

$$t_i = \frac{0.395(1.1 - 0.07)\sqrt{400}}{(0.02)^{0.33}}$$

$$t_i = 29.6 \text{ minutes}$$

Find  $t_t$  from Equation 6-4:

$$t_t = \frac{L_t}{60V_t} = \frac{L_t}{60K\sqrt{S_o}}$$

From Table 6-2,  $K = 15$  (grassed waterway),  $S_o = 0.01$  and  $L = 1500$  feet from problem statement

$$t_t = \frac{1500}{60(15\sqrt{0.01})}$$

$$t_t = 16.7 \text{ minutes}$$

From Equation 6-2:

$$t_c = t_i + t_t$$

$$t_c = 29.6 + 16.7$$



$$t_c = 46.3 \text{ minutes}$$

Check time of concentration from Equation 6-5. (Note that for the second term in the  $t_{reg}$  equation, the length,  $L$ , and the slope,  $S_o$ , input should correspond to the length and slope of the grassed waterway associated with the travel time).

$$t_{reg} = (18 - 15i) + \frac{L_t}{60(24i + 12)\sqrt{S_o}}$$

$$t_{reg} = (18 - 15(2)) + \frac{1500}{60(24(2) + 12)\sqrt{0.01}}$$

$$t_{reg} = 37.7 \text{ minutes}$$

Since  $t_c > t_{reg}$ , use  $t_{reg} = 37.7$  minutes

Determine  $C_{100}$  from Table 6-4:

$$C_{100} = 0.0045i + 0.508$$

$$C_{100} = 0.0045(2) + 0.508$$

$$C_{100} = 0.52$$

Determine rainfall intensity,  $I$ , from Equation 4-3 (from the *Rainfall* chapter)

$$I = \frac{28.5P_1}{(10 + t_c)^{0.786}}$$

$$I = \frac{28.5(2.7)}{(10 + 37.7)^{0.786}}$$

$$I = 3.69 \text{ in/hr}$$

Determine  $Q$  from Equation 6-1:

$$Q = CIA$$

$$Q = (0.52)(3.69)(60)$$

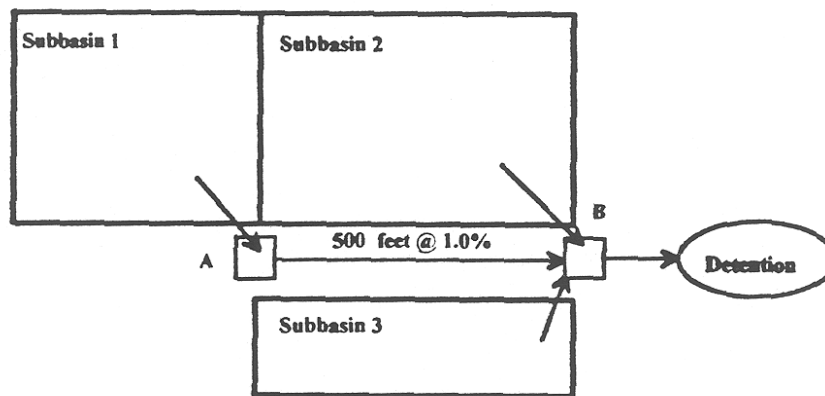
$$Q = 115 \text{ cfs}$$

Alternately, use the UD-Rational Excel workbook to calculate the peak flow rate.

## 7.2 Rational Method Example 2

A watershed is divided into three subcatchments in the City of Denver. The drainage system is designed to collect Subcatchment 1 at Point A, and Subcatchments 2 and 3 at Point B, and then drains into a detention system. Determine the 10-year peak discharge at Point B using the watershed parameters summarized in the table. Assume that the imperviousness is 98 percent.

Subcatchment	Drainage Area A (acres)	Runoff Coefficient C	Time of Concentration $T_c$ (minutes)
1	2.00	0.55	15.00
2	5.00	0.65	22.00
3	1.50	0.81	12.00



As shown in the figure, there are three flow paths to reach Point B. Their flow times are:

**From Subcatchment 1:** The flow time includes the time of concentration of Subcatchment 1, and the flow time from Point A to Point B through the street. The flow time from Subcatchment 1 to Point B is the sum of the time of concentration of Subcatchment 1 and the flow time through the 500-foot gutter:

$$t_1 = t_i + t_t$$

$$t_i = 15 \text{ minutes}$$

$$t_t = \frac{L_t}{60V_t} = \frac{L_t}{60K\sqrt{S_o}}$$

$$t_1 = 15 + \frac{500}{60(20)\sqrt{0.01}} = 19.2 \text{ minutes}$$

From Problem Statement for Subcatchment 2:  $t_2 = 22$  minutes

From Problem Statement for Subcatchment 3:  $t_3 = 12$  minutes

At Point B, the design rainfall duration  $t_d = \max(t_1, t_2, t_3) = 22$  minutes.

The 10-year design rainfall intensity for Denver is (from Equation 4-3 in the *Rainfall* chapter):

$$I = \frac{28.5P_1}{(10 + t_c)^{0.786}}$$

$$I = \frac{28.5(1.61)}{(10 + 22)^{0.786}} = 3.01 \text{ in/hr}$$

An area-weighted runoff coefficient,  $C_{\text{composite}}$ , can be calculated for all of the areas that drain to Point B:

$$C_{\text{composite}} = \frac{(C_1A_1 + C_2A_2 + C_3A_3)}{(A_1 + A_2 + A_3)}$$

$$C_{\text{composite}} = \frac{((0.55)(2) + (0.65)(5) + (0.81)(1.5))}{(2 + 5 + 1.5)} = 0.65$$

The 10-year peak discharge is:

$$Q = CIA = (0.65)(3.01)(8.5) = 16.75 \text{ cfs}$$

## 8.0 References

- Guo, J.C.Y. 1995. *Storm Runoff Prediction Using the Computer Model RATIONAL*. Denver, CO: Urban Drainage and Flood Control District.
- Guo, J.C.Y. 1999. *Streets Hydraulics and Inlet Sizing*: Water Resources Publications, Littleton, CO.
- Guo, J.C.Y. 2013. *Derivation and Calibration of Volume-Based Runoff Coefficients for Denver Metro Area, Colorado*. Denver, CO: UDFCD.
- Guo, James C.Y. and Mackenzie K.(2013). *Modeling Consistency for small to large watershed studies*, JRNHEENG-S-13-00332, ASCE J. of Hydrologic Engineering, August 2013.
- Guo, James C.Y. and Urbonas B. (2013). *Volume-based Runoff Coefficient*, Journal of Irrigation and Drainage Engineering, © ASCE,ISSN 0733-9437/(0). JRNIRENG-S-13-00270.
- Jarrett, R.D. 1984. Hydraulics of High-Gradient Streams. *Journal of the Hydraulics Division* 110(11)1519-1539.
- Jarrett, R.D. 1985. *Determination of Roughness Coefficients for Streams in Colorado*. Water Resources Investigation Report 85-4004. Denver, CO: U.S. Geological Survey.
- MacKenzie, K. A. (2010). *Full-Spectrum Detention for Stormwater Quality Improvement and Mitigation of the Hydrologic Impact of Development*, Master Thesis, Department of Civil Engineering, U of Colorado Denver.
- US Army Corps of Engineers. July 1993. *TD-10 Introduction and Application of Kinematic Wave Routing Techniques Using HEC-1*.
- Urban Drainage and Flood Control District. 2013. *Colorado Urban Hydrograph Procedure (CUHP) 2005 User Manual*. Denver, CO: UDFCD.
- Urbonas, B., J.C.Y. Guo, and L.S. Tucker. 1990. Optimization Stormwater Quality Capture Volume. In *Urban Stormwater Quality Enhancement—Source Control, Retrofitting and Combined Sewer Technology*, ed. H.C. Torno, 94-110. New York: ASCE.



# Chapter 7

## Street, Inlets, and Storm Drains

### Contents

<b>1.0</b>	<b>Introduction.....</b>	<b>1</b>
1.1	Purpose and Background.....	1
1.2	Urban Stormwater Collection and Conveyance Systems.....	1
1.3	System Components.....	2
1.4	Minor and Major Storms.....	2
<b>2.0</b>	<b>Street Drainage.....</b>	<b>3</b>
2.1	Street Function and Classification.....	3
2.2	Design Considerations.....	4
2.3	Hydraulic Evaluation.....	6
2.3.1	Curb and Gutter.....	6
2.3.2	Swale Capacity.....	12
<b>3.0</b>	<b>Inlets.....</b>	<b>13</b>
3.1	Inlet Function and Selection.....	13
3.2	Design Considerations.....	13
3.2.1	Grate Inlets on a Continuous Grade.....	15
3.2.2	Curb-Opening Inlets on a Continuous Grade.....	17
3.2.3	Combination Inlets on a Continuous Grade.....	18
3.2.4	Slotted Inlets on a Continuous Grade.....	18
3.2.5	Grate Inlets in a Sump (UDFCD-CSU Model).....	19
3.2.6	Curb-Opening Inlets in a Sump (UDFCD-CSU Model).....	20
3.2.7	Other Inlets in a Sump (Not Modeled in the UDFCD-CSU Study).....	24
3.2.8	Inlet Clogging.....	28
3.2.9	Nuisance Flows.....	29
3.3	Inlet Location and Spacing on Continuous Grades.....	32
3.3.1	Design Considerations.....	33
3.3.2	Design Procedure.....	33
<b>4.0</b>	<b>Storm Drain Systems.....</b>	<b>34</b>
4.1	Introduction.....	34
4.2	Design Process, Considerations, and Constraints.....	34
4.3	Storm Drain Hydrology—Peak Runoff Calculation.....	36
4.4	Storm Drain Hydraulics (Gravity Flow in Circular Conduits).....	36
4.4.1	Flow Equations and Storm Drain Sizing.....	36
4.4.2	Energy Grade Line and Head Losses.....	38
<b>5.0</b>	<b>UD-Inlet Design Workbook.....</b>	<b>48</b>
<b>6.0</b>	<b>Examples.....</b>	<b>48</b>
6.1	Example—Triangular Gutter Capacity.....	48
6.2	Example—Composite Gutter Capacity.....	49
6.3	Example—Composite Gutter Capacity – Major Storm Event.....	50
6.4	Example—V-Shaped Swale Capacity.....	52
6.5	Example—V-Shaped Swale Design.....	53
6.6	Example—Grate Inlet Capacity.....	54
6.7	Example—Curb-Opening Inlet Capacity.....	56

6.8 Example—Design of a Network of Inlets Using UD-Inlet .....	57
--	----

<b>7.0 References.....</b>	<b>61</b>
----------------------------	-----------

## Tables

Table 7-1. Street classification for drainage purposes.....	3
Table 7-2. Pavement encroachment and inundation standards for the minor storm .....	4
Table 7-3. Street inundation standards for the major (i.e., 100-year) storm .....	5
Table 7-4. Allowable street cross-flow .....	5
Table 7-5. Inlet selection considerations.....	13
Table 7-6. Splash-over velocity constants for various types of inlet grates .....	16
Table 7-7. Coefficients for various inlets in sumps.....	20
Table 7-8. Sump inlet discharge variables and coefficients.....	26
Table 7-9. Clogging coefficient k for single and multiple units <sup>1</sup> .....	28
Table 7-10. Nuisance flows: sources, problems and avoidance strategies.....	31
Table 7-11. Bend loss and lateral loss coefficients (FHWA 2009).....	44
Table 7-12. Head loss expansion coefficients in non-pressure flow (FHWA 2009).....	45

## Figures

Figure 7-1. Gutter section with uniform cross slope .....	7
Figure 7-2. Typical gutter section—composite cross slope .....	8
Figure 7-3. Calculation of composite street section capacity: major storm .....	10
Figure 7-4. Reduction factor for gutter flow (Guo 2000b).....	11
Figure 7-5. Typical v-shaped swale section .....	12
Figure 7-6. CDOT type r and Denver no. 14 interception capacity in sag.....	21
Figure 7-7. CDOT type 13 interception capacity in a sump.....	23
Figure 7-8. Denver no. 16 interception capacity in sump .....	24
Figure 7-9. Perspective views of grate and curb-opening inlets .....	27
Figure 7-10. Orifice calculation depths for curb-opening inlets .....	27
Figure 7-11. A pipe-manhole unit .....	40
Figure 7-12. Hydraulic and energy grade lines .....	40
Figure 7-13. Bend loss coefficients.....	46
Figure 7-14. Manhole benching methods.....	47
Figure 7-15. Angle of cone for pipe diameter changes .....	47

## 1.0 Introduction

### 1.1 Purpose and Background

The purpose of this chapter is to provide design guidance for stormwater collection and conveyance utilizing streets and storm drains. Procedures and equations are presented for the hydraulic design of street drainage, locating inlets and determining capture capacity, and sizing storm drains. This chapter also includes discussion on placing inlets to minimize the potential for icing. Examples are provided to illustrate the hydraulic design process and Excel workbook solutions accompany the hand calculations for most example problems.

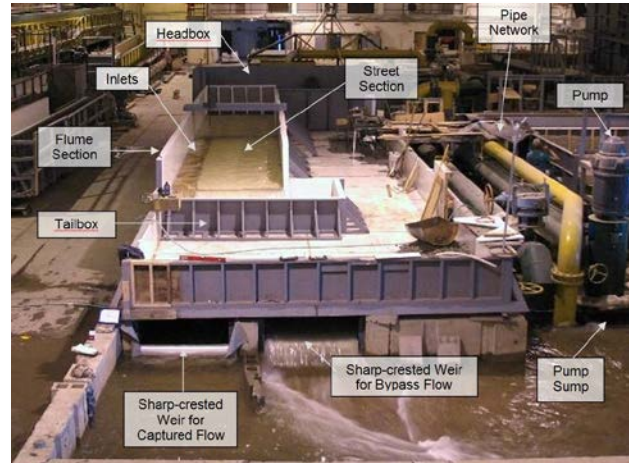
The design procedures presented in this chapter are based upon fundamental hydrologic and hydraulic design concepts. It is assumed that the reader has an understanding of basic hydrology and hydraulics. A working knowledge of the Rational Method (*Runoff* chapter) and open channel hydraulics (*Open Channels* chapter) is particularly helpful. The design equations provided are well accepted and widely used. They are presented without derivations or detailed explanation but are properly referenced if the reader wishes to study their background. Inlet capacity, as presented in this chapter, is based on the FHWA Hydraulic Circular No. 22 (HEC-22) methodology (FHWA 2009), which was subsequently refined through a multi-jurisdictional partnership led by Urban Drainage and Flood Control (UDFCD), where hundreds of physical model tests of inlets commonly used in Colorado were performed at the Colorado State University (CSU) Hydraulics Laboratory. The physical model study is further detailed in technical papers available at [www.udfcd.org](http://www.udfcd.org). Additionally, UDFCD developed an inlet design tool, UD-Inlet, which incorporates the findings of the physical model. UD-Inlet is also available at [www.udfcd.org](http://www.udfcd.org).

### 1.2 Urban Stormwater Collection and Conveyance Systems

Urban stormwater collection and conveyance systems are critical components of the urban infrastructure. Proper design is essential to minimize flood damage and limit disruptions. The primary function of the system is to collect excess stormwater in street gutters, convey it through storm drains and along the street right-of-way, and discharge it into a detention basin, water quality best management practice (BMP), or the nearest receiving water body (FHWA 2009).

Proper and functional urban stormwater collection and conveyance systems:

- Promote safe passage of vehicular traffic during minor storm events.
- Maintain public safety and manage flooding during major storm events.
- Minimize capital and maintenance costs of the system.



**Photograph 7-1.** From 2006 to 2011, hundreds of street and area inlet physical model tests were conducted at the CSU Hydraulics Laboratory, facilitating refinement of the HEC-22 methodology for inlets common to Colorado.



### 1.3 System Components

Urban stormwater collection and conveyance systems are comprised of three primary components:

1. Street gutters and roadside swales,
2. Storm drain inlets, and
3. Storm drains (with appurtenances like manholes, junctions, etc.).

Street gutters and roadside swales collect runoff from the street (and adjacent areas) and convey the runoff to a storm drain inlet while maintaining the street's level of service.



**Photograph 7-2.** The capital costs of storm drain construction are high, emphasizing the importance of sound design.

Inlets collect stormwater from streets and other land surfaces, transition the flow into storm drains, and provide maintenance access to the storm drain system. Storm drains convey stormwater in excess of street or swale capacity along the right-of-way and discharge into a stormwater management facility or directly into a receiving water body. In rare instances, stormwater pump stations (the design of which is not covered in this manual) are needed to lift and convey stormwater away from low-lying areas where gravity drainage is not possible. All of these components must be designed properly to achieve the objectives of the stormwater collection and conveyance system.

### 1.4 Minor and Major Storms

Rainfall events vary greatly in magnitude and frequency of occurrence. Major storms produce large flow rates but rarely occur. Minor storms produce smaller flow rates but occur more frequently. For economic reasons, stormwater collection and conveyance systems are not normally designed to pass the peak discharge during major storm events without some street flooding.

Stormwater collection and conveyance systems are designed to pass the peak discharge of the minor storm event (and smaller events) with minimal disruption to street traffic. To accomplish this, the spread and depth of water on the street is limited to some maximum mandated value during the minor storm event. Inlets must be strategically placed to pick up excess gutter or swale flow once the limiting allowable spread or depth of water is reached. The inlets collect and convey stormwater into storm drains, which are typically sized to pass the peak flow rate (minus the allowable street flow rate) from the minor storm without any surcharge. The magnitude of the minor storm is established by local ordinances or criteria, and the 2- or 5-year storms are commonly specified, based on many factors including street function, traffic load, vehicle speed, etc.

Local ordinances often also establish the return period for the major storm event, generally the 100-year storm (although it may be a lesser event for some retrofit projects with site constraints). During this event, runoff exceeds the minor storm allowable spread and depth in the street and capacity of storm drains, and storm drains may surcharge. Street flooding occurs, and traffic is disrupted as the street functions as an open channel. The designer must evaluate and design for the major event with regard to maintaining public safety and minimizing flood damages.

## 2.0 Street Drainage

### 2.1 Street Function and Classification

Although streets play an important role in stormwater collection and conveyance, the primary function of a street or roadway is to provide for the safe passage of vehicular traffic at a specified level of service. If stormwater systems are not designed properly, this primary function will be impaired. To ensure this does not happen, streets are classified for drainage purposes based on their traffic volume, parking practices, and other criteria (Wright-McLaughlin Engineers 1969). The four street classifications are:

- Local: Low-speed traffic for residential or industrial area access.
- Collector: Low/moderate-speed traffic providing service between local streets and arterials.
- Arterial: Moderate/high-speed traffic moving through urban areas and accessing freeways.
- Freeway: High-speed travel, generally over long distances.

Table 7-1 provides additional information on the classification of streets for drainage purposes.

**Table 7-1. Street classification for drainage purposes**

<b>Street Classification</b>	<b>Function</b>	<b>Speed/Number of Traffic Lanes</b>	<b>Signalization at Intersections</b>	<b>Street Parking</b>
Local	Provides access to residential and industrial areas	Low speed / 2 lanes	Stop signs	One or both sides of the street
Collector	Collects and convey traffic between local and arterial streets	Low to moderate speed / 2 to 4 lanes	Stop signs or traffic signals	One or both sides of the street
Arterial	Delivers traffic between urban centers and from collectors to freeways	Moderate to high speed / 4 to 6 lanes	Traffic signals (controlled access)	Usually prohibited
Freeway	Provides rapid and efficient transport over long distances	High-speed / 4 or more lanes	Separated interchanges (limited access)	Always prohibited

Proper street drainage is essential to:

- Maintain the street's level of service.
- Minimize danger and inconvenience to pedestrians during storm events (FHWA 1984).
- Reduce potential for vehicular skidding and hydroplaning.
- Maintain good visibility for drivers (by reducing splash and spray).

## 2.2 Design Considerations

Certain design considerations must be taken into account in order to meet street drainage objectives. For the minor storm, the primary design objective is to keep the spread (encroachment onto the pavement) and depth (inundation) of stormwater on the street below acceptable limits for a given return period of flooding. As mentioned previously, when stormwater collects on the street and flows down the gutter, the spread (width) of the water increases as more stormwater is collected and conveyed down the street and gutter. Left unchecked, the spread of water will eventually hinder traffic flow and become hazardous (e.g., hydroplaning, reduced skid resistance, visibility impairment from splash back, engine stalls). Based on these considerations, UDFCD has established encroachment and inundation standards for the minor storm event. These standards were presented in the *Policy* chapter and are repeated in Table 7-2 for convenience.

**Table 7-2. Pavement encroachment and inundation standards for the minor storm**

Street Classification	Maximum Encroachment and Inundation
Local	No curb overtopping. Flow may spread to crown of street.
Collector	No curb overtopping. Flow spread must leave at least one lane free of water.
Arterial	No curb overtopping. Flow spread must leave at least one lane free of water in each direction, and should not flood more than two lanes in each direction.
Freeway	No encroachment is allowed onto any traffic lanes.

During the major event, flood protection and human safety replace drivability as the design criteria with regard to street inundation (depth of flow). UDFCD has established street inundation standards during the major storm event. These standards were given in the *Policy* chapter and are repeated in Table 7-3 for convenience.

**Table 7-3. Street inundation standards for the major (i.e., 100-year) storm**

Street Classification	Maximum Depth and Inundated Area
Local and Collector	Residential dwellings and public, commercial, and industrial buildings should be no less than 12 inches above the 100-year flood at the ground line or lowest water entry of the building. The depth of water over the gutter flow line should not exceed 12 inches.
Arterial and Freeway	Residential dwellings and public, commercial, and industrial buildings should be no less than 12 inches above the 100-year flood at the ground line or lowest water entry of the building. The depth of water should not exceed the street crown to allow operation of emergency vehicles. The depth of water over the gutter flow line should not exceed 12 inches.

Standards for the major storm and street cross-flows are also required. These standards apply at intersections, sump locations, and for culvert or bridge overtopping scenarios. The major storm needs to be assessed to determine the potential for flooding and public safety. Street cross-flows also need to be regulated for traffic flow and public safety reasons. These allowable street cross-flow standards were given in the *Policy* chapter and are repeated in Table 7-4 for convenience.

**Table 7-4. Allowable street cross-flow**

Street Classification	Initial Storm Flow	Major (100-Year) Storm Flow
Local	6 inches of depth in cross-pan.	12 inches of depth above gutter flow line.
Collector	Where cross-pans allowed, depth of flow should not exceed 6 inches.	12 inches of depth above gutter flow line.
Arterial/Freeway	None.	No cross-flow. Maximum depth at upstream gutter on road edge of 12 inches.

Once the allowable spread (pavement encroachment) and allowable depth (inundation) have been established for the minor storm, the placement of inlets can be determined. The inlets will remove some or all of the excess stormwater and thus reduce the spread and depth of flow. The placement of inlets is covered in Section 3.0. It should be noted that proper drainage design seeks to maximize the full allowable capacity of the street gutter in order to minimize the cost of inlets and storm drains.

Two additional design considerations are gutter geometry and street slope. Most urban streets incorporate curb and gutter sections. Various types exist, including spill shapes, catch shapes, curb heads, and mountable, a.k.a. “rollover” or “Hollywood” curbs. The shape is chosen for functional, cost, or aesthetic reasons and does not dramatically affect the hydraulic capacity. Swales are used along some semi-urban streets, and roadside ditches are common along rural streets. Cross-sectional geometry, longitudinal slopes and swale/ditch roughness values are important in determining hydraulic capacity and are covered in the next section.

## 2.3 Hydraulic Evaluation

Hydraulic computations are performed to determine the capacity of roadside swales and street gutters and the encroachment of stormwater onto the street. The design discharge is based on the peak flow rate and usually is determined using the rational method (covered in the next two sections and in the *Runoff* Chapter). Although gutter, swale/ditch and street flows are unsteady and non-uniform, steady, uniform flow is assumed for the short time period of peak flow conditions.

### 2.3.1 Curb and Gutter

Both the longitudinal and cross (transverse) slope of a street are important in calculating hydraulic capacity. The capacity of the street increases as the longitudinal slope increases. UDFCD prescribes a minimum longitudinal slope of 0.4% for positive drainage (Wright-McLaughlin 1969). Public safety considerations limit the maximum allowable flow capacity of the gutter on steep slopes. The cross slope represents the slope from the street crown to the interface of the street and gutter, measured perpendicular to the direction of traffic. UDFCD recommends a minimum cross slope of 1% for positive drainage; however, a cross slope of 2% is more typical. Driver comfort and safety considerations limit the maximum cross slope. Use of standard curb and gutter sections typically produces a composite section with milder cross slopes for drive lanes and steeper cross slopes within the gutter width for increased flow capacity.

Each side of the street is evaluated independently. The hydraulic evaluation of street capacity includes the following steps:

1. Calculate the street capacity based upon the allowable spread for the minor storm as defined in Table 7-2.
2. Calculate the street capacity based upon the allowable depth for the minor storm as defined in Table 7-2.
3. Calculate the allowable street capacity by multiplying the value calculated in step two (limited by depth) by the reduction factor provided in Figure 7-3. The lesser value (limited by allowable spread or by depth with a safety factor applied) is the allowable street capacity.
4. Repeat steps one through three for the major storm using criteria in Table 7-3.

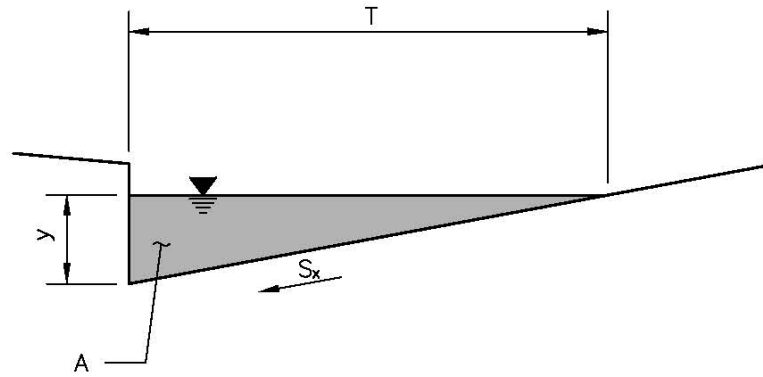
#### **Capacity When Gutter Cross Slope Equals Street Cross Slope (Not Typical)**

Streets with uniform cross slopes like that shown in Figure 7-1 are sometimes found in older urban areas. Since gutter flow is assumed to be uniform for design purposes, Manning's equation is appropriate with a slight modification to account for the effects of a small hydraulic depth ( $A/T$ ).

#### **Street Hydraulic Capacity**

This term typically refers to the capacity from the face of the curb to the crown (for the minor event).

Typically, the hydraulic computations necessary to determine street capacity and required inlet locations are performed independently for each side of the street. Additionally, flow and street geometry frequently differ from one side of a street to the other.



**Figure 7-1. Gutter section with uniform cross slope**

For a triangular cross section as shown in Figure 7-1, Manning's equation for gutter flow is written as:

$$Q = \frac{1.8}{n} AR^{2/3} S_o^{1/2} = \frac{0.56}{n} S_x^{5/3} S_o^{1/2} T^{8/3} \quad \text{Equation 7-1}$$

Where:

$Q$  = calculated flow rate for the half-street (cfs)

$n$  = Manning's roughness coefficient (0.016 for asphalt street with concrete gutter, 0.013 for concrete street and gutter)

$R$  = hydraulic radius of wetted cross section =  $A/P$  (ft)

$A$  = cross-sectional area (ft<sup>2</sup>)

$P$  = wetted perimeter of cross section (ft)

$S_x$  = street cross slope (ft/ft)

$S_o$  = longitudinal slope (ft/ft)

$T$  = top width of flow spread (ft).

The flow depth can be found using:

$$y = TS_x \quad \text{Equation 7-2}$$

Where:

$y$  = flow depth at the gutter flowline (ft).

Note that the flow depth generally should not exceed the curb height during the minor storm based on Table 7-2. Manning's equation can be written in terms of the flow depth, as:

$$Q = \frac{0.56}{n S_x} S_o^{1/2} y^{8/3} \quad \text{Equation 7-3}$$

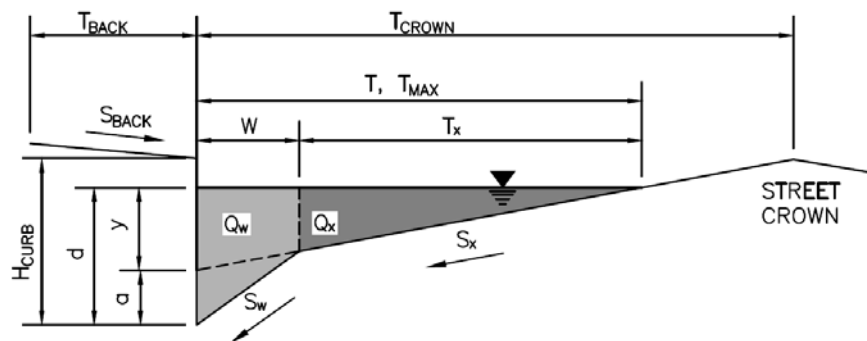
The cross-sectional flow area,  $A$ , can be expressed as:

$$A = \frac{S_x T^2}{2} \tag{Equation 7-4}$$

The gutter velocity at peak capacity may be found from continuity ( $V = Q/A$ ). Triangular gutter cross-section calculations are illustrated in Example 7.1.

**Capacity When Gutter Cross Slope is Not Equal to Street Cross Slope (Typical)**

Streets with composite cross slopes like that shown in Figure 7-2 are often used to increase the gutter capacity and keep nuisance flows out of the traffic lanes.



**Figure 7-2. Typical gutter section—composite cross slope**

For a composite street section:

$$Q = Q_w + Q_x \tag{Equation 7-5}$$

Where:

$Q_w$  = flow rate in the depressed gutter section (flow within gutter width,  $W$ , in Figure 7-2 [cfs])

$Q_x$  = flow rate in the section that is outside the depressed gutter section and within the street width,  $T_x$ , in Figure 7-2 (cfs).

In *Hydraulic Engineering Circular No. 22, Third Edition*, the Federal Highway Administration (FHWA 2009) provides the following equations for obtaining the flow rate in streets with composite cross slopes. The theoretical flow rate,  $Q$ , is:

$$Q = \frac{Q_x}{1 - E_o} \tag{Equation 7-6}$$

Where:

$$E_o = \frac{1}{1 + \frac{S_w/S_x}{\left[1 + \frac{S_w/S_x}{(T/W) - 1}\right]^{8/3}} - 1} \quad \text{Equation 7-7}$$

and,

$$S_w = S_x + \frac{a}{W} \quad \text{Equation 7-8}$$

Where:

$E_o = Q_w/Q$ , the ratio of gutter flow,  $Q_w$ , to total flow  $Q$

$W$  = width of the gutter (typical value = 2 ft)

$S_w$  = the gutter cross slope (typical value = 1/12 or 0.0833 [ft/ft])

$a$  = gutter depression =  $WS_w - WS_x$  (typical value for  $WS_w$  for a 2-ft gutter section is 0.1667 ft).

Figure 7-2 depicts all geometric variables. From the geometry, it can be shown that:

$$y = a + TS_x \quad \text{Equation 7-9}$$

and,

$$A = \frac{S_x T^2 + aW}{2} \quad \text{Equation 7-10}$$

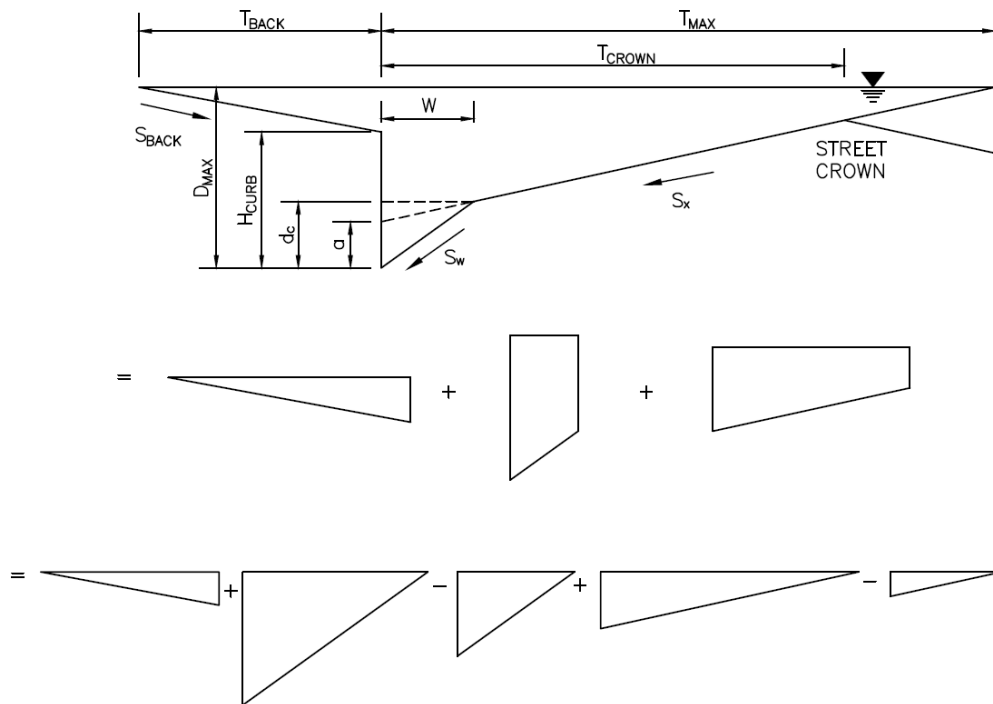
Where:

$y$  = flow depth above depressed gutter section (ft). Note that the depth of flow at the gutter line is defined as  $d$ , where  $d = y + a$  (see Figure 7-2).

$A$  = flow area (ft<sup>2</sup>)

Due to the complexity of Equation 7-7, care should be taken when calculating  $E_o$ . Additionally,  $E_o$  cannot be correctly calculated using Equation 7-7 when  $T < W$  or when ponding depth exists at the street crown. For these special cases, the principle of similar triangles may be applied in conjunction with Equation 7-1 (see Figure 7-3). Both methods for calculating flow in a composite cross-section are illustrated in the Examples and the end of this chapter (see Examples 7.2 and 7.3).





**Figure 7-3. Calculation of composite street section capacity: major storm**

**Allowable Capacity**

Stormwater flows along streets exert momentum forces on cars, pavement, and pedestrians. To limit the hazardous nature of large street flows, it is necessary to set limits on flow velocities and depths. As a result, the allowable half-street hydraulic capacity is determined as the lesser of:

$$Q_A = Q_T \tag{Equation 7-11}$$

or

$$Q_A = R Q_d \tag{Equation 7-12}$$

Where:

$Q_A$  = allowable street hydraulic capacity (cfs)

$Q_T$  = street hydraulic capacity where flow spread equals allowable spread (cfs)

$R$  = reduction factor (allowable street and gutter flow for safety)

$Q_d$  = street hydraulic capacity where flow depth equals allowable depth (cfs).

There are two sets of safety reduction factors developed for the UDFCD region (Guo 2000b). One is for the minor event, and another is for the major event. Figure 7-4 shows that the safety reduction factor does not apply unless the street longitudinal slope is more than 1.5% for the major event and 2% for the minor event. The safety reduction factor, representing the fraction of calculated gutter flow at maximum depth

that is used for the allowable design flow, decreases as longitudinal slope increases.

It is important for street drainage designs that the allowable street hydraulic capacity be used instead of the calculated gutter-full capacity. Where the accumulated stormwater amount on the street approaches the allowable capacity, a street inlet should be installed.

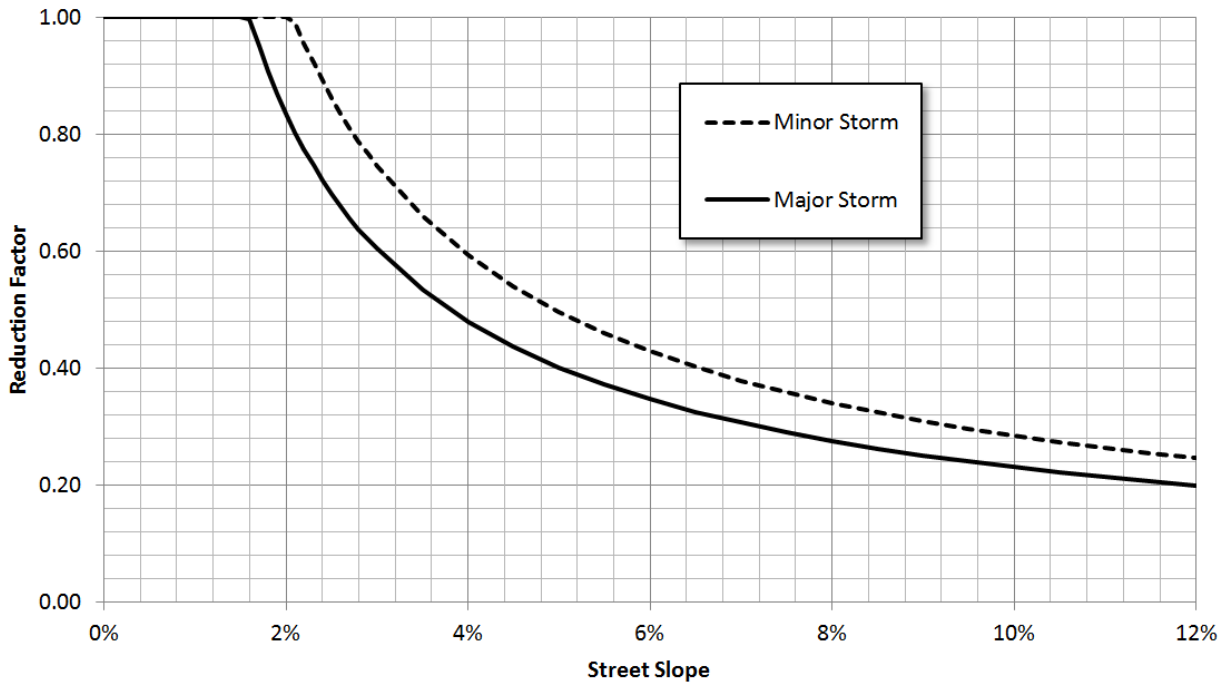


Figure 7-4. Reduction factor for gutter flow (Guo 2000b)

### 2.3.2 Swale Capacity

Where curb and gutter are not used to contain flow, swales are frequently used to convey runoff and disconnect impervious areas. It is very important that swale depths and side slopes be shallow for safety and maintenance reasons. Street-side drainage swales are not the same as roadside ditches. Street-side drainage swales provide mild side slopes and are frequently designed to provide water quality enhancement. For purposes of disconnecting impervious area and reducing the overall volume of runoff, swales should be considered as collectors of initial runoff for transport to other larger means of conveyance. To be effective, they need to be limited to the velocity, depth, and cross-slope geometries considered acceptable.

Equation 7-1 can be used to calculate the flow rate in a V-section swale (using the appropriate roughness value for the swale lining) with an adjusted cross slope found using:

$$S_x = \frac{S_{x1}S_{x2}}{S_{x1} + S_{x2}} \quad \text{Equation 7-13}$$

Where:

$S_x$  = adjusted side slope (ft/ft)

$S_{x1}$  = right side slope (ft/ft)

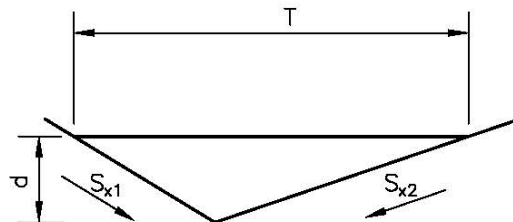
$S_{x2}$  = left side slope (ft/ft).

Figure 7-5 shows the geometric variables, and Examples 7.4 and 7.5 show V-shaped swale calculations.

For safety reasons, paved swales should be designed such that the product of velocity and depth is no more than six for the minor storm and eight for the major storm.

For grass swales, refer to the *Grass Swale Fact Sheet* in the Urban Storm Drainage Criteria Manual (USDCM) Volume 3. During the 2-year event, grass swales designed for water quality should have a Froude number of no more than 0.5, a velocity that does not exceed 1.0 ft/s, and a depth that does not exceed 1.0 foot.

Note that the slope of a roadside ditch or swale can be different than the adjacent street. The hydraulic characteristics of the swale can therefore change from one location to another.



**Figure 7-5. Typical v-shaped swale section**

## 3.0 Inlets

### 3.1 Inlet Function and Selection

Inlets collect excess stormwater from the street, transition the flow into storm drains, and can provide maintenance access to the storm drain system. There are four major types of inlets: grate, curb opening, combination, and slotted (see Figure 7-11). Table 7-5 provides considerations in proper selection.

**Table 7-5. Inlet selection considerations**

Inlet Type	Applicable Setting	Advantages	Disadvantages
Grate	Sumps and continuous grades (should be made bicycle safe)	Perform well over wide range of grades	Can become clogged Lose some capacity with increasing grade
Curb-opening	Sumps and continuous grades (but not steep grades)	Do not clog easily Bicycle safe	Lose capacity with increasing grade
Combination	Sumps and continuous grades (should be made bicycle safe)	High capacity Do not clog easily	More expensive than grate or curb-opening acting alone
Slotted	Locations where sheet flow must be intercepted.	Intercept flow over wide section	Susceptible to clogging

### 3.2 Design Considerations

Frequently roadway geometry dictates the location of inlets. Inlets are placed at low points (sumps), median breaks, and at intersections. Additional inlets should be placed where the design peak flow on the street half is approaching the allowable capacity of the street half (see inset). Allowable street capacity will be exceeded and storm drains will be underutilized when inlets are not located properly or not designed for adequate capacity (Akan and Houghtalen 2002).

Inlets placed on continuous grades are generally designed to intercept only a portion of the gutter flow during the minor (design) storm (i.e. some flow bypasses to downgradient inlets). The effectiveness of the inlet is expressed as efficiency defined as:

$$E = Q_i / Q$$

Equation 7-15

Where:

$E$  = inlet efficiency (fraction of gutter flow captured by inlet)

$Q_i$  = intercepted flow rate (cfs)

$Q$  = total half-street flow rate (cfs).

#### Allowable Street Capacity

To a great degree, *allowable street capacity* dictates the placement of inlets. This term refers to the lesser of:

- Capacity determined by the allowable spread for the minor event
- Capacity determined by the allowable depth for the minor event, multiplied by a reduction factor

Bypass (or carryover) flow is not intercepted by the inlet. By definition,

$$Q_b = Q - Q_i \quad \text{Equation 7-16}$$

Where:

$Q_b$  = bypass (or carryover) flow rate (cfs).

The ability of an inlet to intercept flow (i.e., hydraulic capacity) on a continuous grade increases to a degree with increasing gutter flow, but the capture efficiency decreases. In general, the inlet capacity depends upon:

- The inlet type and geometry (length, width, curb opening, etc.),
- The flow rate,
- The longitudinal slope,
- The cross (transverse) slope.

The capacity of an inlet varies with the type of inlet. For grate inlets, the capacity is largely dependent on the amount of water flowing over the grate, the grate configuration and spacing. For curb-opening inlets, the capacity is largely dependent on the length of the opening, street and gutter cross slope, and the flow depth at the curb. Local gutter depression at the curb opening will increase the capacity. Combination inlets on a continuous grade (i.e., not in a sump location) intercept up to 18% more than grate inlets alone and are much less likely to clog completely (CSU 2009). Slotted inlets function in a manner similar to curb-opening inlets (FHWA 2009).

Inlets in sumps operate as weirs at shallow ponding and as orifices as depth increases. A transition region exists between weir flow and orifice flow, much like a culvert. Grate inlets and slotted inlets have a higher tendency to clog with debris than do curb-openings inlets, so calculations should take that into account.

The hydraulic capacity of an inlet is dependent on the type of inlet (grate, curb opening, combination, or slotted) and the location (on a continuous grade or in a sump). The methodology for determination of hydraulic capacity of the various inlet types is described in the following sections.



(a) CDOT Type 13 grated inlet in combination configuration



(b) Denver No. 16 grated inlet in combination configuration



(c) CDOT Type R curb-opening inlet

**Photograph 7-3.** These three street inlets are the most commonly used in the UDFCD region. Their performance was tested for both on grade conditions and in sump conditions in a 1/3-scale physical model at CSU.

### 3.2.1 Grate Inlets on a Continuous Grade

The capture efficiency of a grate inlet on a continuous grade is highly dependent on the width of the grate and, to a lesser degree, the length. In general, most of the flow within the width of the grate will be intercepted and most of the flow outside the width of the grate (i.e., in the street) will not. The velocity of gutter flow also affects capture efficiency. If the gutter velocity is low and the spread of water does not exceed the grate width, all of the flow will be captured by the grate inlet. This is not normally the case, even during the minor (design) storm. The spread of water often exceeds the grate width and the flow velocity can be high. Thus, some of the flow within the width of the grate may “splash over” the grate, and unless the inlet is very long, very little of the flow outside the grate width is captured.

In order to determine the efficiency of a grate inlet, flow with respect to the grate is divided into two parts: frontal flow and side flow. Frontal flow is defined as that portion of the flow within the width of the grate. The portion of the flow outside the grate width is called side flow. By using Equation 7-1 for a uniform cross slope, the frontal flow can be evaluated and is expressed as:

$$Q_w = Q \left[ 1 - (1 - (W/T))^{2.67} \right] \quad \text{Equation 7-17}$$

Where:

- $Q_w$  = frontal discharge (flow within width  $W$ ) (cfs)
- $Q$  = total gutter flow (cfs) found using Equation 7-1
- $W$  = width of grate (ft)
- $T$  = total spread of water in the half-street (ft).

For a composite cross section, use Equations 7-5 through 7-8, substituting the grate width for the gutter width. It should be noted that the grate width is generally only slightly less than the depressed section in a composite gutter section. Now by definition:

$$Q_x = Q - Q_w \quad \text{Equation 7-18}$$

Where:

- $Q_x$  = side discharge (i.e., flow outside the depressed gutter or grate) (cfs).

The ratio of the frontal flow intercepted by the inlet to total frontal flow,  $R_f$ , is expressed as:

$$R_f = \frac{Q_{wi}}{Q_w} = 1.0 - 0.09(V - V_o) \text{ for } V \geq V_o, \text{ otherwise } R_f = 1.0 \quad \text{Equation 7-19}$$

Where:

- $Q_{wi}$  = frontal flow intercepted by the inlet (cfs)
- $V$  = velocity of flow in the gutter (ft/sec)
- $V_o$  = splash-over velocity (ft/sec).

The splash-over velocity is defined as the minimum velocity where some of the water will begin to skip over the full length of the grate. This velocity is a function of the grate length and type. The splash-over velocity can be determined using this empirical formula (Guo 1999):

$$V_o = \alpha + \beta L_e - \gamma L_e^2 + \eta L_e^3 \tag{Equation 7-20}$$

Where:

- $V_o$  = splash-over velocity (ft/sec)
- $L_e$  = effective length of grate inlet (ft)
- $\alpha, \beta, \gamma, \eta$  = constants from Table 7-6.

The splash-over velocity constants for the CDOT Type 13 and the Denver No. 16 grates were derived during the UDFCD-CSU study and are valid for effective lengths up to 15 feet, while the splash-over velocity constants for all other inlet grates are valid only for effective lengths up to four feet. Beyond the maximum effective lengths for which these constants have been validated through physical modeling, the splash-over velocity may be estimated as that maximum validated velocity plus 0.2 ft/s for each additional foot of effective inlet length.



**Photograph 7-4.** Gutter/street slope is a major design factor for both street and inlet capacity.

**Table 7-6. Splash-over velocity constants for various types of inlet grates**

Type of Grate	$\alpha$	$\beta$	$\gamma$	$\eta$
CDOT/Denver 13Valley Grate	0.00	0.680	0.060	0.0023
CDOT Type C Standard Grate	2.22	4.03	0.65	0.06
CDOT Type C Close Mesh Grate	0.74	2.44	0.27	0.02
Denver No. 16 Valley Grate	0.00	0.815	0.074	0.003
Directional Cast Vane Grate	0.30	4.85	1.31	0.15
Directional 45-Degree Bar Grate	0.99	2.64	0.36	0.03
Directional 30-Degree Bar Grate	0.51	2.34	0.2	0.01
Reticuline Riveted Grate	0.28	2.28	0.18	0.01
Wheat Ridge Directional Grate	0.00	0.815	0.074	0.003
1-7/8" Bar Grate, Crossbars @ 8"	2.22	4.03	0.65	0.06
1-7/8" Bar Grate, Crossbars @ 4"	0.74	2.44	0.27	0.02
1-1/8" Bar Grate, Crossbars @ 8"	1.76	3.12	0.45	0.03

The ratio of the side flow intercepted by the inlet to total side flow,  $R_x$ , is expressed as:

$$R_x = \frac{1}{1 + \frac{0.15V^{1.8}}{S_x L^{2.3}}} \tag{Equation 7-21}$$

Where:

- $V$  = velocity of flow in the gutter (ft/sec)

$L$  = length of grate (ft).

The capture efficiency,  $E$ , of the grate inlet may now be determined using:

$$E = R_f(Q_w/Q) + R_x(Q_x/Q) \quad \text{Equation 7-22}$$

Example 7.6 shows grate inlet capacity calculations.

### 3.2.2 Curb-Opening Inlets on a Continuous Grade

The capture efficiency of a curb-opening inlet is dependent on the length of the opening, the depth of flow at the gutter flow line, street cross slope and the longitudinal gutter slope (see Photograph 7-4). If the curb opening is long, the flow rate is low, and the longitudinal gutter slope is small, all of the flow will be captured by the inlet. It is generally uneconomical to install a curb opening long enough to capture all of the flow during the minor (design) storm. Thus, some water gets by the inlet, and the inlet efficiency needs to be determined.

The hydraulics of curb-opening inlets are less complicated than grate inlets. The efficiency,  $E$ , of a curb-opening inlet is calculated as:

$$E = 1 - [1 - (L/L_T)]^{1.8} \text{ for } L < L_T, \text{ otherwise } E = 1.0 \quad \text{Equation 7-23}$$

Where:

$L$  = curb-opening length (ft)

$L_T$  = curb-opening length required to capture 100% of gutter flow (ft).

For a curb-opening inlet in a uniform cross slope (see Figure 7-1),  $L_T$  can be calculated as:

$$L_T = 0.38Q^{0.51} S_L^{0.058} \left( \frac{1}{nS_x} \right)^{0.46} \quad \text{Equation 7-24}$$

Where:

$Q$  = total flow (cfs)

$S_L$  = longitudinal street slope (ft/ft)

$S_x$  = street cross slope (ft/ft)

$n$  = Manning's roughness coefficient.

But most curb-opening inlets are in a composite street section and many also have a localized depression, so  $L_T$  should then be calculated as:

$$L_T = 0.38Q^{0.51} S_L^{0.058} \left( \frac{1}{nS_e} \right)^{0.46} \quad \text{Equation 7-25}$$

The equivalent cross slope,  $S_e$ , can be determined from:



$$S_e = S_x + \frac{(a + a_{local})}{W} E_o \quad \text{Equation 7-26}$$

Where:

$a$  = gutter depression (as defined for Equation 7-8)

$a_{local}$  = any additional local depression in the area of the inlet (typically specific to the type of inlet)

$W$  = depressed gutter width as shown in Figure 7-2.

The ratio of the flow in the depressed section to total gutter flow,  $E_o$ , can be calculated from Equation 7-7. See Examples 7.6 and 7.7 for curb-opening inlet calculations.

### 3.2.3 Combination Inlets on a Continuous Grade

Combination inlets take advantage of the debris removal capabilities of a curb-opening inlet and the capture efficiency of a grate inlet. Combination inlets on a continuous grade (i.e., not in a sump location) intercept 18% more than grate inlets alone and are much less likely to clog completely (CSU 2009). A special case combination where the curb opening extends upstream of the grated section is called a sweeper inlet. The inlet capacity is enhanced by the additional upstream curb-opening length, and debris is intercepted there before it can clog the grate. The construction of sweeper inlets is more complicated and costly however, and they are not commonly seen in the UDFCD region. To calculate interception efficiency for a sweeper inlet, the upstream curb-opening efficiency is calculated first and then the interception efficiency for combination section based on the remaining street flow is added to it. To analyze this within UD-Inlet select *user-defined combination*, select a grate type, and check the *sweeper configuration* box.

### 3.2.4 Slotted Inlets on a Continuous Grade

Slotted inlets can be used in place of curb-opening inlets or can be used to intercept sheet flow that is crossing the pavement in an undesirable location. Unlike grate inlets, they have the advantage of intercepting flow over a wide section. They do not interfere with traffic operations and can be used on both curbed and uncurbed sections. Like grate inlets, they are susceptible to clogging.

Slotted inlets placed parallel to flow in the gutter flow line function like side-flow weirs, much like curb-opening inlets. The FHWA (1996) suggests the hydraulic capacity of slotted inlets closely corresponds to curb-opening inlets if the slot openings exceed 1.75 inches. Therefore, the equations developed for curb-opening inlets (Equations 7-23 through 7-26) are appropriate for those slotted inlets.



**Photograph 7-5.** Inlets that are located in street vertical sag curves (sumps) are highly efficient.

### 3.2.5 Grate Inlets in a Sump (UDFCD-CSU Model)

All of the stormwater draining to a sump inlet must pass through an inlet grate or curb opening to enter the storm drain. This means that clogging due to debris can result not only in underutilized pipe conveyance, but also ponding of water on the surface. Surface ponding can be a nuisance or hazard. Therefore, the capacity of inlets in sumps must account for this clogging potential. Grate inlets acting alone are not recommended for this reason. Curb-opening and combination (including sweeper) inlets are more appropriate. In all sump inlet locations, consider the risk and required maintenance associated with a fully clogged condition and design the system accordingly. Photograph 7-5 shows a curb-opening inlet in a sump condition. At this location, if the inlet clogs, standing water will be limited to the elevation at the back of the walk.

The flow through a grated sump inlet varies with respect to depth and continuously changes from weir flow (at shallow depths) to mixed flow (at intermediate depths), and also orifice flow (at greater depths). For CDOT Type 13 grates and Denver No. 16 grates (the most common grated street inlets in the UDFCD region), from the UDFCD-CSU physical model study, the classic formulas for weir and orifice flow were modified with weir length and open area ratios specifically as:

$$Q_w = N_w C_w (2W_g + L_e) D^{3/2} \quad \text{Equation 7-27}$$

$$Q_o = N_o C_o W_g L_e \sqrt{2gD} \quad \text{Equation 7-28}$$

Where:

$Q_w$  = weir flow (cfs)

$Q_o$  = orifice flow (cfs)

$W_g$  = grate width (ft)

$L_e$  = effective grate length after clogging (ft)

$D$  = water depth at gutter flow line outside the local depression at the inlet (ft)

$N_w$  = weir length reduction factor

$N_o$  = orifice area reduction factor

$C_w$  = weir discharge coefficient

$C_o$  = orifice discharge coefficient

The transient process between weir and orifice flows is termed mixed flow and is modeled as:

$$Q_m = C_m \sqrt{Q_w Q_o} \quad \text{Equation 7-29}$$

Where:

$Q_m$  = mixed flow (cfs)

$C_m$  = mixed flow coefficient

The recommended values for the coefficients  $N_w$ ,  $N_o$ ,  $C_w$ ,  $C_m$ , and  $C_o$  are listed in Table 7-7.

In practice, for the given water depth, it is suggested that the interception capacity,  $Q_i$ , for the sump grate be the smallest among the weir, orifice, and mixed flows as:

$$Q_i = \min(Q_w, Q_m, Q_o) \quad \text{Equation 7-30}$$

### 3.2.6 Curb-Opening Inlets in a Sump (UDFCD-CSU Model)

Like a grate inlet, a curb-opening inlet operates under weir, orifice, or mixed flow. From the UDFCD-CSU physical model study, the HEC-22 procedure was found to overestimate the capacity of the CDOT Type R, the Denver No. 14, and other, similar curb-opening inlets for the minor storm event, and underestimate capacity for the major event. From the UDFCD-CSU study of these inlets, the interception capacity is based on the depression and opening geometry and can be estimated as:

$$Q_w = C_w N_w L_e D^{3/2} \quad \text{Equation 7-31}$$

$$Q_o = C_o N_o (L_e H_c) \sqrt{2g(D - 0.5H_c)} \quad \text{Equation 7-32}$$

Where:

$H_c$  = height of the curb-opening throat (ft)

$D$  = water depth at gutter flow line outside the local depression at the inlet (ft).

The recommended values for the coefficients  $N_w$ ,  $N_o$ ,  $C_w$ ,  $C_m$ , and  $C_o$  are listed in Table 7-7. Once weir and orifice interception rates are calculated, Equations 7-29 and 7-30 must also be applied to curb-opening inlets in sag locations.

**Table 7-7. Coefficients for various inlets in sumps**

Inlet Type	$N_w$	$C_w$	$N_o$	$C_o$	$C_m$
CDOT Type 13 Grate	0.70	3.30	0.43	0.60	0.93
Denver No. 16 Grate	0.73	3.60	0.31	0.60	0.90
Curb Opening for Type 13 / No. 16 Combination	1.0	3.70	1.0	0.66	0.86
CDOT Type R Curb Opening	1.0	3.60	1.0	0.67	0.93

The UDFCD-CSU study demonstrated a phenomenon referred to as weir performance decay, which is a function of the length of the inlet. It was found that inlets become less effective in weir flow as they grow in length, if the intent is to limit ponding to less than or equal to the curb height. This phenomenon can be expressed mathematically by a multiplier in the weir equation. For the CDOT Type R and Denver No. 14 curb-opening inlets, the weir performance reduction factor (WPRF) multiplier is found by:

$$\text{WPRF}_{14,R} = \text{Min} \left[ 1, \frac{D_{FL}}{0.67D_{FL} + 0.24\text{min}(15, L)} \right] \quad \text{Equation 7-33}$$

Where:

$WPRF_{14,R}$  = multiplier to reduce  $Q_w$  in Equation 7-31 for the CDOT Type R and the Denver No. 14 inlet

$D_{FL}$  = gutter depth at flow line away from inlet depression (inches)

$L$  = total inlet length (ft)

This reduction factor should be applied to weir equations for curb-opening inlet shallow depth interception calculations.

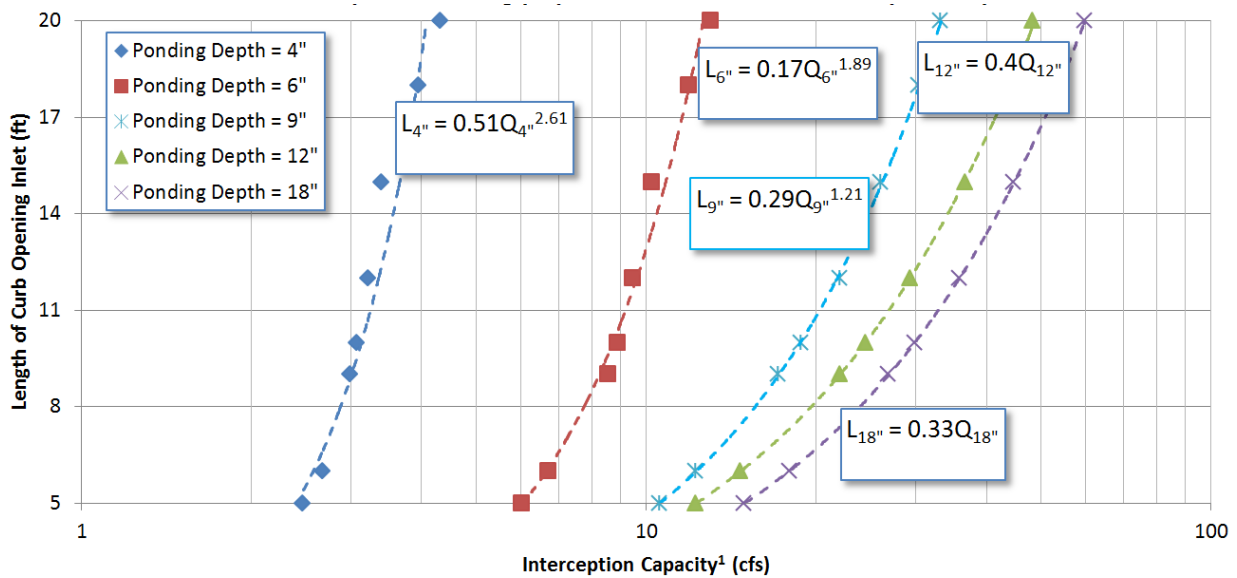


**Photograph 7-6.** Weir performance decay can be observed in this picture as flow appears to enter only the first two inlets while exceeding the height of the upstream curb.

From the UDFCD-CSU study, empirical equations to estimate interception capacity for the CDOT Type R and the Denver No. 14 curb-opening inlets were developed and are shown in Figures 7-5 and 7-6.

### Weir Performance Decay

Inlets become less effective in weir flow as they grow in length. What this means is that adding inlets to reduce the depth of flow will typically not increase total capacity when the inlet is in weir flow. This is important to consider this when designing for the minor event. In an effort to meet minor event depth criteria, the system may need to be extended further upstream.



1 This value assumes inlet clogging per Section 3.2.9.

**Figure 7-6. CDOT type r and Denver no. 14 interception capacity in sag**

For the CDOT Type 13, the Denver No. 16, and other, similar combination inlets featuring cast iron adjustable-height curb boxes, the curb-opening capacity must be added to the grate capacity as determined in Section 3.3.5. Regardless of how tall the vertical curb opening is, water captured by these curb openings must enter through a narrow horizontal opening under the curb head and in the plane of the grate. Therefore the capacity of the curb opening associated with these combination inlets is estimated based on that horizontal throat opening geometry using Equation 7-31 for the weir condition, and for the orifice condition as:

$$Q_o = C_o N_o (0. W_c L_e) \sqrt{2gD} \quad \text{Equation 7-34}$$

Where:

$W_c$  = horizontal orifice width (typically 0.44 feet for the CDOT Type 13, the Denver No. 16, and other, similar combination inlets featuring cast iron adjustable-height curb boxes)

Once weir and orifice interception rates are calculated, Equations 7-29 and 7-30 must also be applied to the curb-opening portion of combination inlets in sag locations.

After the controlling interception rate for the grate and for the curb opening have been calculated as the minimum of the weir, orifice, and mixed flows, a reduction factor tied to the geometric mean of the grate and curb-opening capacities should be applied to the algebraic sum of the total interception as:

$$Q_t = Q_g + Q_c - K \sqrt{Q_g Q_c} \quad \text{Equation 7-35}$$

Where:

$Q_t$  = interception capacity for combination inlet (cfs)

$Q_g$  = interception for grate (cfs)

$Q_c$  = interception for curb opening (cfs)

$K$  = dimensionless reduction factor (= 0.37 for CDOT Type 13 combination inlet, = 0.21 for Denver No. 16 combination inlet).

A higher reduction factor implies higher interference between the grate and the curb opening. The HEC-22 procedure assumes that the grate and curb opening function independently, resulting in a consistent overestimation of the capacity of combination inlets.  $K$  is a lumped, average parameter representing the range of observed water depths in the laboratory. During the model tests, it was observed that when the grate surface area is subject to shallow water, the curb opening intercepted the flow only at its two corners, and did not behave as a side weir by collecting flow along its full length. Under deep water, vortex circulation dominates the flow pattern. As a result, the central portion of the curb opening more actively draws water into the inlet box. Equation 7-35 best represents the range of the observed data.

The UDFCD-CSU study demonstrated that the Denver No. 16 and the CDOT Type 13 combination inlets are also subject to weir performance decay, which was described above with regard to the CDOT Type R and Denver No. 14 curb-opening inlets. For the Denver No. 16 and the CDOT Type 13 combination inlets, the WPRF multiplier is found by:

$$WPRF_{13,16} = \text{Min} \left[ 1, \frac{D_{FL}}{0.7\text{Min}(9, L) + 4.3} \right] \quad \text{Equation 7-36}$$

Where:

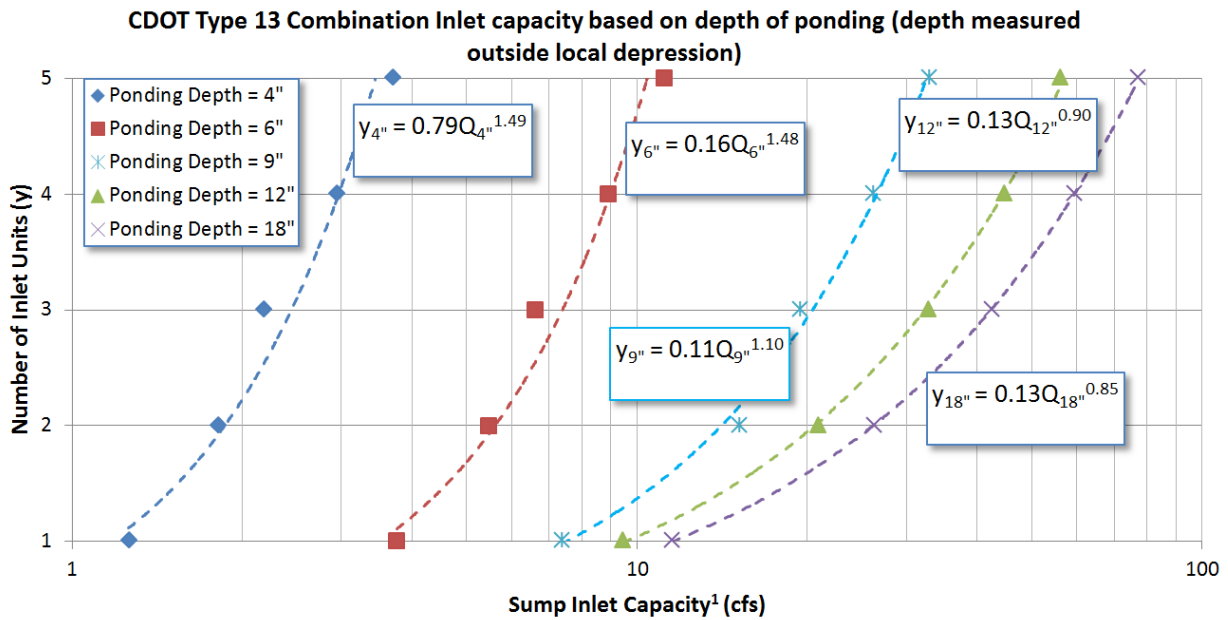
$WPRF_{13,16}$  = multiplier to reduce  $Q_w$  in Equation 7-31 for the CDOT Type 13 and the Denver No. 16 inlet

$D_{FL}$  = gutter depth at flow line away from inlet depression (inches)

$L$  = total inlet length (ft).

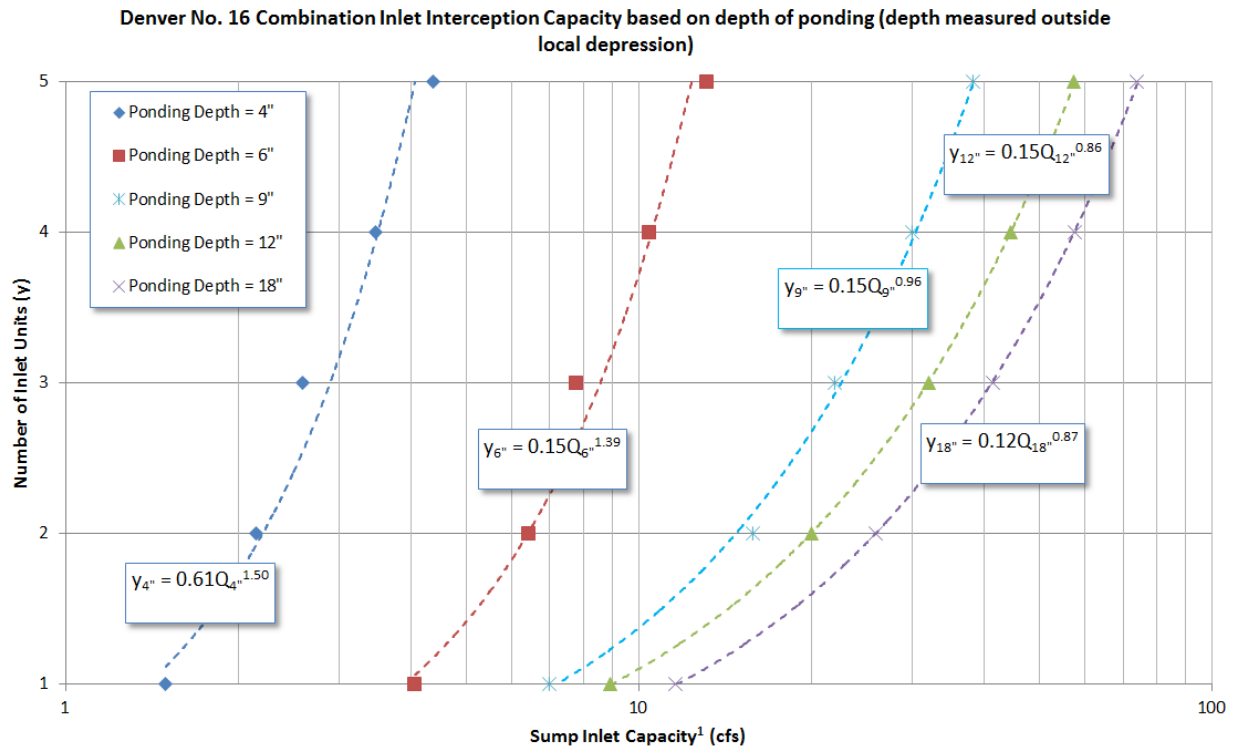
This reduction factor should be applied to both the grate and the curb opening weir equations (Equation 7-31) for combination inlet shallow depth interception calculations.

From the UDFCD-CSU study, empirical equations to estimate interception capacity for the CDOT Type 13 and the Denver No. 16 combination inlets were developed and are shown in Figures 7-7 through 7-10.



<sup>1</sup> This value assumes inlet clogging per Section 3.2.9.

**Figure 7-7. CDOT type 13 interception capacity in a sump**



<sup>1</sup> This value assumes inlet clogging per Section 3.2.9.

**Figure 7-8. Denver no. 16 interception capacity in sump**

### 3.2.7 Other Inlets in a Sump (Not Modeled in the UDFCD-CSU Study)

The hydraulic capacity of grate, curb-opening, and slotted inlets operating as weirs is expressed as:

$$Q_i = C_w L_w d^{1.5} \tag{Equation 7-37}$$

Where:

- $Q_i$  = inlet capacity (cfs)
- $C_w$  = weir discharge coefficient
- $L_w$  = weir length (ft)
- $d$  = flow depth (ft).

Values for  $C_w$  and  $L_w$  are presented in Table 7-8 for various inlet types. Note that the expressions given for curb-opening inlets without depression should be used for depressed curb-opening inlets if  $L > 12$  feet.

The hydraulic capacity of grate, curb-opening, and slotted inlets operating as orifices is expressed as:

$$Q_i = C_o A_o (2gd)^{0.5} \quad \text{Equation 7-38}$$

Where:

$Q_i$  = inlet capacity (cfs)

$C_o$  = orifice discharge coefficient

$A_o$  = orifice area (ft<sup>2</sup>)

$d$  = characteristic depth (ft) as defined in Table 7-8

$g$  = 32.2 ft/sec<sup>2</sup>.

Values for  $C_o$  and  $A_o$  are presented in Table 7-8 for different types of inlets.

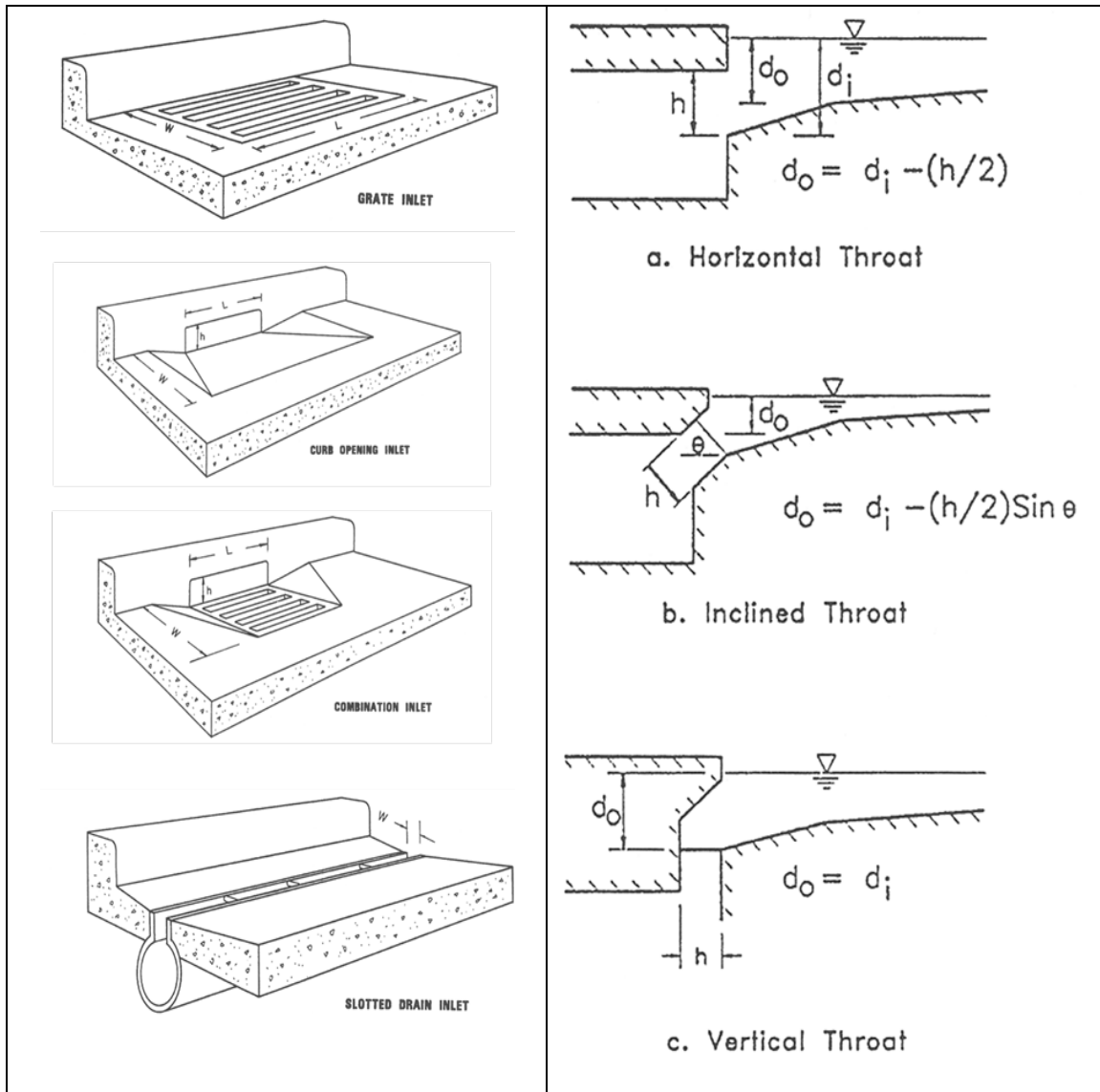
Combination inlets are commonly used in sumps. The hydraulic capacity of combination inlets in sumps depends on the type of flow and the relative lengths of the curb opening and grate. For weir flow, the capacity of a combination inlet (grate length equal to the curb opening length) is equal to the capacity of the grate portion only. This is because the curb opening does not add any effective length to the weir. If the curb opening is longer than the grate, the capacity of the additional curb length should be added to the grate capacity. For orifice flow, the capacity of the curb opening should be added to the capacity of the grate.



**Table 7-8. Sump inlet discharge variables and coefficients**

(Modified From Akan and Houghtalen 2002)

Inlet Type	$C_w$	$L_w^1$	Weir Equation Valid For	Definitions of Terms
Grate Inlet	3.00	$L + 2W$	$d < 1.79(A_o/L_w)$	$L$ = Length of grate (ft) $W$ = Width of grate (ft) $d$ = Depth of water over grate (ft) $A_o$ = Clear opening area <sup>2</sup> (ft <sup>2</sup> )
Curb-opening Inlet	3.00	$L$	$d < h$	$L$ = Length of curb opening (ft) $h$ = Height of curb opening (ft) $d = d_i - (h/2)$ (ft) $d_i$ = Depth of water at curb opening (ft)
Depressed Curb Opening Inlet <sup>3</sup>	2.30	$L + 1.8W$	$d < (h + a)$	$W$ = Lateral width of depression (ft) $a$ = Depth of curb depression (ft)
Slotted Inlets	2.48	$L$	$d < 0.2$ ft	$L$ = Length of slot (ft) $d$ = Depth at curb (ft)
<sup>1</sup> The weir length should be reduced where clogging is expected. <sup>2</sup> Ratio of clear opening area to total area is 0.8 for P-1-7/8-4 and reticuline grates, 0.9 for P-1-7/8 and 0.6 for P-1-1/8 grates. Curved vane and tilt bar grates are not recommended at sump locations unless in combination with curb openings. <sup>3</sup> If $L > 12$ ft, use the expressions for curb-opening inlets without depression.				
	$C_o$	$A_o^4$	Orifice Equation Valid for	Definition of Terms
Grate Inlet	0.67	Clear opening area <sup>5</sup>	$d > 1.79(A_o/L_w)$	$d$ = Depth of water over grate (ft)
Curb-opening Inlet (depressed or undepressed, horizontal orifice throat <sup>6</sup> )	0.67	$(h)(L)$	$d_i > 1.4h$	$d = d_i - (h/2)$ (ft) $d_i$ = Depth of water at curb opening (ft) $h$ = Height of curb opening (ft)
Slotted Inlet	0.80	$(L)(W)$	$d > 0.40$ ft	$L$ = Length of slot (ft) $W$ = Width of slot (ft) $d$ = Depth of water over slot (ft)
<sup>4</sup> The orifice area should be reduced where clogging is expected. <sup>5</sup> The ratio of clear opening area to total area is 0.8 for P-1-7/8-4 and reticuline grates, 0.9 for P-1-7/8 and 0.6 for P-1-1/8 grates. Curved vane and tilt bar grates are not recommended at sump locations unless in combination with curb openings. <sup>6</sup> See Figure 7-12 for other types of throats.				



**Figure 7-9. Perspective views of grate and curb-opening inlets**

**Figure 7-10. Orifice calculation depths for curb-opening inlets**  
 (note that the equation for the inclined throat is also valid for the other cases)

### 3.2.8 Inlet Clogging

Inlets are subject to clogging effects (see Photograph 7-6). Selection of a clogging factor reflects the condition of debris and trash on the street. During a storm event, street inlets are usually loaded with debris by the first-flush runoff volume. As a common practice for street drainage, 50% clogging is considered for the design of a single grate inlet and 10% clogging is considered for a single curb-opening inlet. Often, it takes multiple units to collect the stormwater on the street. Since the amount of debris is largely associated with the first-flush volume in a storm event, the clogging factor applied to a multiple-unit street inlet should be decreased with respect to the length of the inlet.



**Photograph 7-6.** Clogging is an important consideration when designing inlets.

Linearly applying a single-unit clogging factor to a multiple-unit inlet will lead to an excessive increase in inlet length. For example, if a 50% clogging factor is applied to a six-unit inlet, the inlet would be presumed to function as a three-unit inlet. In reality, the upgradient units of the inlet would be more susceptible to clogging (perhaps at the 50% level) than the downgradient portions. In fact, continuously applying a 50% reduction to the discharge on the street will always leave 50% of the residual flow on the street. This means that the inlet will never reach a 100% capture and leads to unnecessarily long inlets. To address this phenomenon, UDFCD has developed Equation 7-39 which calculates a “decayed” clogging factor when multiple inlet units are used together.

With the concept of first-flush volume, the decay of clogging factor to grate or curb-opening length is described as (Guo 2000a):

$$C = \frac{1}{N} (C_o + eC_o + e^2C_o + e^3C_o + \dots + e^{N-1}C_o) = \frac{C_o}{N} \sum_{i=1}^{i=N} e^{i-1} = \frac{KC_o}{N} \tag{Equation 7-39}$$

Where:

- C = multiple-unit clogging factor for an inlet with multiple units
- C<sub>o</sub> = single-unit clogging factor
- e = decay ratio less than unity, 0.5 for grate inlet, 0.25 for curb-opening inlet
- N = number of grate units, or, for curb openings, L/5
- K = clogging coefficient from Table 7-9.

**Table 7-9. Clogging coefficient k for single and multiple units<sup>1</sup>**

N for Grate Inlets or (L/5) for Curb-Openings	1	2	3	4	5	6	7	8	>8
K for Grate Inlet	1	1.5	1.75	1.88	1.94	1.97	1.98	1.99	2
K for Curb Opening Inlet	1	1.25	1.31	1.33	1.33	1.33	1.33	1.33	1.33

<sup>1</sup> This table is generated by Equation 7-39 with e = 0.5 and e = 0.25.

When  $N$  becomes large, Equation 7-39 converges to:

$$C = \frac{C_o}{N(1 - e)} \quad \text{Equation 7-40}$$

For instance, when  $e = 0.5$  and  $C_o = 50\%$ ,  $C = 1.0/N$  for a large number of units,  $N$ . In other words, only the first unit out of  $N$  units will be clogged. Equation 7-40 complies with the recommended clogging factor for a single-unit inlet and decays on the clogging effect for a multiple-unit inlet.

The interception of an inlet on a grade is proportional to the inlet length and, in a sump, is proportional to the inlet opening area. Therefore, a clogging factor should be applied to the length of the inlet on a grade as:

$$L_e = (1 - C)L \quad \text{Equation 7-41}$$

in which  $L_e$  = effective (unclogged) length (ft). Similarly, a clogging factor should be applied to the opening area of an inlet in a sump as:

$$A_e = (1 - C)A \quad \text{Equation 7-42}$$

Where:

$A_e$  = effective opening area (ft<sup>2</sup>)

$A$  = opening area (ft<sup>2</sup>).

### 3.2.9 Nuisance Flows

The location of inlets is important to address the effects of nuisance flows and avoid icing. Nuisance flows are urban runoff flows that are typically most notable during dry weather and come from sources such as over-irrigation and snow melt. Nuisance flows cause problems in both warm and cold weather months. Problems include algae growth and ice. While it is possible to minimize nuisance conditions through design, irrigation practices in the summer and snow and ice removal in the winter make it very difficult to eliminate nuisance flows entirely. Because these practices are largely controlled by residents and business, municipalities should plan for maintenance to address nuisance flow conditions, particularly in the winter when ice accumulation can impede the ability of the drainage system to serve its purpose.

In the summer months, over-irrigation of lawns and landscaping can be a major contributor to nuisance flows. Car washing is another summertime cause of excess flows. In homes with poor or improper drainage, excessive sump pump discharge may also contribute.

In winter months, snow and ice melt are the primary causes of nuisance flows and associated icing problems (see Photograph 7-7). Discharges from sump pumps to the sidewalk and/or street can also lead to icing.

Flows over sidewalks and driveways due to summertime nuisance flows can cause algae growth, especially if fertilizer is being used in conjunction with over-irrigation. Such algae growth is both a safety issue due to increased falling risk resulting from slippery surfaces and an aesthetic issue. Nuisance flows laden with fertilizer, sediment, and other pollutants also have the potential to overload stormwater BMPs, which are generally designed for lower pollutant concentrations found in typical wet weather flows. Additionally, continually moist conditions can create an environment where fecal bacteria thrive, either becoming an ongoing dry weather source of bacteria loading or a source that is subsequently mobilized under wet weather conditions, such as in the case of biofilm southing.



**Photograph 7-7.** The location of inlets is important to address the effects of nuisance flows.

Public education about proper irrigation rates and irrigation system maintenance (e.g., broken or misaligned sprinkler heads) can help reduce occurrences of excess flow over sidewalks. Additionally, homeowners can be encouraged to direct downspout and sump pump discharges to swales, lawns, and gardens (keeping away from foundation backfill zones) where water can infiltrate. Algae growth is encouraged by the presence of nutrients which can come from fertilizer and organic matter. Algae growth can be reduced by educating homeowners on proper application of fertilizer (both rates and timing of application), using phosphorus-free fertilizer, and sweeping up dead leaves and plant matter on impervious surfaces. Whenever feasible, impervious surfaces should be swept rather than sprayed down with water. When power-washing of outdoor surfaces is conducted, comply with local, state and federal regulations.

Snow and ice melt can re-freeze on streets and sidewalks, where it poses hazards to the public and is difficult to remove. Often, icing is most significant on east-west streets that have less solar exposure in the winter. Trees, buildings, fences and topography can also create shady areas where ice accumulates. Snow and ice may also clog drains and inlets, leading to flooding. Snowmelt has been found to have high pollutant concentrations which can stress treatment facilities. Because many of the issues related to winter nuisance flows are beyond the control of municipalities (especially in areas that are already developed), identifying problem areas and planning for maintenance is often the most effective practice for minimizing nuisance conditions.

Table 7-10 provides the various sources, problems, and avoidance strategies associated with nuisance flows.

**Table 7-10. Nuisance flows: sources, problems and avoidance strategies**

	<b>Warm Weather</b>	<b>Cold Weather</b>
<b>Examples/Sources</b>	<ul style="list-style-type: none"> <li>▪ Over-irrigation of lawns and landscaping</li> <li>▪ Car washing</li> <li>▪ Sump pump discharge</li> </ul>	<ul style="list-style-type: none"> <li>▪ Snowmelt</li> <li>▪ Ice Melt</li> <li>▪ Sump pump discharge (freezing)</li> </ul>
<b>Problems</b>	<ul style="list-style-type: none"> <li>▪ Poor water quality</li> <li>▪ High nutrient concentration</li> <li>▪ High pollutant concentration</li> <li>▪ Algae Growth</li> </ul>	<ul style="list-style-type: none"> <li>▪ Icing leading to inlet blockage and flooding</li> <li>▪ Ice on streets and sidewalks</li> <li>▪ High pollutant concentrations</li> </ul>
<b>Avoidance Strategies</b>	<ul style="list-style-type: none"> <li>▪ Irrigation, drainage, and fertilizer education</li> <li>▪ Proper drainage design</li> <li>▪ Minimization of directly connected impervious area</li> <li>▪ Sidewalk chase drains</li> </ul>	<ul style="list-style-type: none"> <li>▪ Inlet and sidewalk maintenance</li> <li>▪ Prompt and frequent snow and ice removal</li> <li>▪ Consider additional inlets in strategic locations</li> <li>▪ Shoveling snow onto grassy areas away from streets and inlets</li> <li>▪ Locate inlets and sumps away from shaded areas</li> </ul>

Homeowners, business owners, maintenance and city workers should be educated and encouraged to use proper snow and ice removal techniques. These include removal of snow and ice promptly and frequently, keeping drains and gutters clear, and placing shoveled snow onto lawns or grassy areas.

For new development projects, locating inlets in areas where water can be intercepted before it accumulates or slows down and has the opportunity to freeze is the most effective way to minimize icing from the design perspective. To the extent practical, locate inlets away from areas that will be heavily shaded during winter months (in particular the north side of buildings) to help prevent ice build-up and allow proper flow. For areas where shading is unavoidable, consider providing additional inlet capacity at strategic locations. For example, if a street with a southern exposure will drain to an east-west street that is shaded, having additional inlet capacity at the intersection may be advisable, especially if the flow is intended to turn and follow the east-west street. It is also important to consider potential future vegetative growth when evaluating shading effects. Although trees may be small and have little canopy when originally planted, they will grow and ultimately provide far greater tree canopy far greater than when initially planted. Tree canopy may vary seasonally, depending on the tree species (e.g., deciduous trees lose their leaves in the fall, so less canopy is present in the winter). Ultimately, even with careful placement of inlets and avoidance of shading to the extent practical, icing in some locations will still likely occur due to shading from buildings, fences and other improvements on private property, and maintenance to remove accumulated ice will be necessary. For areas that are already developed, maintenance (i.e., snow and ice removal) to control icing from nuisance flows is the primary method to address icing, and for many municipalities, this is an ongoing part of their street maintenance programs.



**Photograph 7-8.** Inlets frequently need maintenance.

During all times of the year, it is important that nuisance flows can be properly conveyed to storm drain outlets. Ponding on streets and sidewalks promotes both ice and algae growth. Sidewalk chase drains may be appropriate to aid in proper drainage of nuisance flows (for sump pump discharges, in particular); however, sidewalk chases can be problematic in terms of clogging and icing if they are located in areas with heavy loads of gross solids (leaves, grocery bags, restaurant litter, etc.) or if they are located in areas with poor solar exposure in winter months.

For more information on nuisance flows, multiple Colorado-based publications are available to provide guidance related to landscape management practices and snow and ice removal. Representative resources include:

- USDCM Volume 3, Source Control BMPs
- GreenCO BMP Manual
- Colorado State University Extension Yard and Garden Fact Sheets.

### **3.3 Inlet Location and Spacing on Continuous Grades**

Although one should always perform interception capacity computations on stormwater inlets, the ultimate location (or positioning) of those inlets is rarely a function of interception alone. Often, inlets are required in certain locations based upon street design considerations, topography (sumps), and local ordinances. One notable exception is the location and spacing of inlets on continuous grades. On a long continuous grade, stormwater flow increases as it moves down the gutter and picks up more drainage area. As the flow increases, so does the spread and depth. Since the spread (encroachment) and depth (inundation) are not allowed to exceed some specified maximum, inlets must be strategically placed to

remove some of the stormwater from the street. Locating these inlets requires design computations by the engineer.

### 3.3.1 Design Considerations

The primary design considerations for the location and spacing of inlets on continuous grades are the encroachment and inundation limitations. This was addressed in Section 2.2. Table 7-2 lists pavement encroachment and inundation standards for minor storms in the UDFCD region.

Proper design of stormwater collection and conveyance systems makes optimum use of the conveyance capabilities of street gutters, such that an inlet is not needed until the spread (encroachment) and depth (inundation) reach allowable limits during the design (minor) storm. To place an inlet prior to that point on the street is not economically efficient. To place an inlet after that point would violate the encroachment and inundation standards. Therefore, the primary design objective is to position inlets along a continuous grade at the locations where the allowable spread and/or depth is about to be exceeded for the design storm.

### 3.3.2 Design Procedure

Based on the encroachment and inundation standards and the given street geometry, the allowable street hydraulic capacity can be determined using Equation 7-11 and Equation 7-12. This flow rate is then equated to some hydrologic technique (equation) that contains drainage area. In this way, the inlet is positioned on the street so that it will service the requisite drainage area. The process of locating the inlet is accomplished by trial-and-error. If the inlet is moved downstream (or down gutter), the drainage area increases. If the inlet is moved upstream, the drainage area decreases.

The hydrologic technique most often used in urban drainage design is the rational method. The rational method was discussed in the *Runoff* chapter. The rational method, repeated here for convenience, is:

$$Q = CIA \quad \text{Equation 7-43}$$

Where:

$Q$  = peak discharge (cfs)

$C$  = runoff coefficient described in the *Runoff* chapter

$I$  = design storm rainfall intensity (in/hr) described in the *Rainfall* chapter

$A$  = drainage area (acres).

The design process starts with the selection of the proposed first inlet in the system. The peak discharge for the half-street at this point is calculated by the rational method, using runoff coefficients and rainfall intensities as described in the *Runoff* Chapter. Next, the allowable peak discharge is found using the allowable spread and depth calculated as functions of the street geometry at the design point. If the allowable peak discharge is less than the watershed peak discharge, the proposed design point is too far downstream in the watershed and must be moved upstream. If the allowable peak discharge is much greater than the calculated peak discharge, no inlet is required at the proposed design point and a new location for the proposed first inlet in the system is selected somewhere downstream of this location. The ultimate goal is to always place an inlet just upstream of the point where the allowable spread and/or depth criteria would otherwise be exceeded.

Once the first inlet location is identified along a continuous grade, an inlet type and size can be specified. The first inlet's hydraulic capacity is then assessed. Generally, it is uneconomical to size an inlet (on



continuous grades) large enough to capture all of the gutter flow. Instead, some carryover flow is expected. This practice reduces the amount of new flow that can be picked up at the next inlet. However, each inlet should be positioned at the location where the spread or depth of flow is about to reach its allowable limit.

The gutter discharge for inlets (other than the most upstream inlet), consists of the carryover (bypassed) flow from the upstream inlet plus the stormwater runoff generated from the intervening local drainage area. The carryover flow from the upstream inlet is added to the peak flow rate obtained from the rational method for the intervening local drainage area. The resulting peak flow is conservatively approximate since the carryover flow peak and the local runoff peak do not necessarily coincide.

## 4.0 Storm Drain Systems

### 4.1 Introduction

Once stormwater is collected from the street by an inlet, it is directed into the storm drain system. The storm drain system is comprised of inlets, pipes, manholes, bends, outlets, and other appurtenances. For specific information regarding the applicability of a number of available pipe materials, a document titled “Storm Sewer Pipe Material Technical Memorandum” is available for download at [www.udfcd.org](http://www.udfcd.org).

Apart from inlets, manholes are the most common appurtenance in storm drain systems. Their primary functions include:

- Providing maintenance access.
- Serving as junctions when two or more pipes merge.
- Providing flow transitions for changes in pipe size, slope, and alignment.
- Providing ventilation.

Manholes are generally made of pre-cast or cast-in-place reinforced concrete. They are typically four to five feet in diameter and are required at regular intervals, even in straight sections, for maintenance reasons. Standard size manholes cannot accommodate large pipes, so special junction vaults are constructed for that application.

Occasionally, bends and transitions are accomplished without manholes, particularly for large pipe sizes. These sections provide gradual transitions in size or alignment to minimize energy losses. Outlet structures, covered in the *Hydraulic Structures* chapter, are transitions from pipe flow into open channel flow or still water (e.g., ponds, lakes, etc.). Their primary function is to provide a transition that minimizes erosion in the receiving water body. Occasionally, flap gates or other types of check valves are placed on outlet structures to prevent backflow from high tailwater or flood-prone receiving waters.

### 4.2 Design Process, Considerations, and Constraints

The design of a storm drain system requires a large data collection effort. The data requirements in the proposed service area include topography, drainage boundaries, imperviousness, soil types, and locations of any existing storm drain conduits, inlets, and manholes. In addition, identification of the type and location of other utilities in the ground is critical. Alternative layouts of a new system (or modifications to an existing system) can be investigated using these data.

System layouts rely largely on street rights-of-way and topography. Most layouts are dendritic (tree)

networks that follow the street pattern. Dendritic networks collect stormwater from a broad area and converge in the downstream direction. Networks with parallel branches are possible but are less common and require full hydraulic modeling. Each layout should depict inlet and manhole locations, drainage boundaries serviced by the inlets, pipe locations, flow directions, and outlet locations. A final layout selection is made from the viable alternatives based on likely system performance and cost.

Once a final layout is chosen, storm drain pipes are sized based on the hydrology (peak flows) and hydraulics (pipe capacities). This is accomplished by designing the upstream pipes first and moving downstream. Pipe diameters less than 15 inches are not recommended for storm drains, and many communities have adopted an 18-inch diameter minimum standard. Pipes generally increase in size moving downstream since the drainage area (and thus flow) is increasing. Downstream pipes should never be smaller than upstream pipes, even if a steeper slope is encountered that will provide sufficient capacity with a smaller pipe. The potential for clogging at the resulting “choke point” is always a concern.

Storm drains are typically sized to convey the minor storm without surcharging, using open channel hydraulics calculations to determine normal depth 100% full pipe depth. Because the maximum capacity of a circular pipe occurs at approximately 93% of the depth of full pipe flow, designing for full flow will result in slightly conservative design. The minor storm typically is defined by a return interval from the 2-year to the 5-year storm depending on the function of the infrastructure being served. Refer to the *Policy* chapter for guidance regarding selection of the design storm.

Manholes are located in the system in conjunction with pipe sizing and inlet placement, where manhole locations are dictated by standard design practices. For example, manholes are required whenever there is a lateral pipe servicing an inlet, and where a change occurs in pipe size, alignment, or slope. In addition, manholes are required at pipe branch junctions. Manholes are also required along long straight sections of pipe for maintenance purposes, with the distance between manholes dependent on pipe size, but not more than 400 feet. The invert of a pipe leaving a manhole should be at least 0.1 foot lower than the incoming pipe to ensure positive low flows through the manhole. Whenever possible, match the pipe soffit elevations when the downstream pipe is larger to minimize backwater effects on the upstream pipe. Additional manholes may be necessary to “step down” a steep grade, allowing pipe slopes to be much flatter than the slope of the street above. This is done to prevent velocities in storm drain pipes from exceeding the recommended maximum velocity of 20 ft/sec.

Once storm drain pipes are sized and manhole locations are determined, the performance of the storm drain system must be evaluated using energy grade line calculations starting at the downstream system outlet. As stormwater flows through the storm drain system, it encounters many flow transitions. These transitions include changes in pipe size, slope and alignment, as well as entrance and exit conditions. All of these transitions consume energy, resulting in energy losses expressed as head losses. These losses must be accounted for to ensure that inlets and manholes do not surcharge to a significant degree (i.e., produce street flooding). This is accomplished using hydraulic grade line (HGL) calculations as a check on pipe sizes and system losses. If significant surcharging occurs, the pipe sizes should be increased. High tailwater conditions at the storm drain outlet may also produce surcharging. This can also be accounted for using HGL calculations.

### 4.3 Storm Drain Hydrology—Peak Runoff Calculation

The rational method is commonly used to determine the peak flow rates that storm drain systems must be able to convey. It is an appropriate method for the small drainage areas typically involved. It is also relatively easy to use and provides reasonable estimates of peak runoff. The total drainage area contributing flow to a particular storm drain is sometimes divided into smaller subcatchments. The rational method is described in the *Runoff* chapter of the USDCM.

The first pipe in a storm drain system is sized using Equation 7-43 to determine the peak flow. Downstream pipes receive flow from the upstream pipes as well as local inflows. The rational method applied to the downstream pipes is:

$$Q = I \sum_{j=1}^n C_j A_j \quad \text{Equation 7-44}$$

Where:

$I$  = rainfall intensity based on the time of concentration for the total contributing area (in/hr)

$n$  = number of subcatchments above the stormwater pipe

$C_j$  = runoff coefficient of subcatchment  $j$

$A_j$  = drainage area of subcatchment  $j$  (acres)

In using this equation, it is evident that the peak flow changes at each design point since the time of concentration, and thus the average intensity, changes at each design point. It is also evident that the time of concentration coming from the local inflow may differ from that coming from upstream pipes. Normally, the longest time of concentration is chosen for design purposes. If this is the case, all of the subcatchments above the design point will be included in Equation 7-44, and it usually produces the largest peak flow. On occasion, the peak flow from a shorter path may produce the greater peak discharge if the downstream areas are heavily developed. It is good practice to check all alternative flow paths and tributary areas to determine the tributary zone that produces the biggest design flow, especially when some of the tributary areas are highly impervious with rapid runoff responses.

### 4.4 Storm Drain Hydraulics (Gravity Flow in Circular Conduits)

#### 4.4.1 Flow Equations and Storm Drain Sizing

Storm drain flow is unsteady and non-uniform. However, for design purposes it can be assumed to be steady and uniform at the peak flow rate, thereby allowing Manning's equation to be applied for determining pipe capacity:

$$Q = \frac{1.49}{n} AR^{2/3} S_f^{1/2} \quad \text{Equation 7-45}$$

Where:

$Q$  = flow rate (cfs)

$n$  = Manning's roughness factor

$A$  = flow area (ft<sup>2</sup>)

$R$  = hydraulic radius (ft)

$S_f$  = friction slope (normally assumed to be the storm drain slope) (ft/ft)

For full flow in a circular storm drain,

$$A = A_f = \frac{\pi D^2}{4} \quad \text{Equation 7-46}$$

$$R = R_f = \frac{D}{4} \quad \text{Equation 7-47}$$

Where:

$D$  = pipe diameter (ft)

$A_f$  = flow area at full flow (ft<sup>2</sup>)

$R_f$  = hydraulic radius at full flow (ft).

If the flow is pressurized (i.e., surcharging at the manholes or inlets is occurring),  $S_f \neq S_o$  where  $S_o$  is the longitudinal slope of the storm drain pipe. Design of storm drains assumes just-full flow, a reference condition referring to steady, uniform flow with a flow depth,  $y$ , nearly equal to the pipe diameter,  $D$ . Just-full flow discharge,  $Q_f$ , is calculated using:

$$Q_f = \frac{1.49}{n} A_f R_f^{2/3} S_o^{1/2} \quad \text{Equation 7-48}$$

Computations of flow characteristics for partial depths in circular pipes are tedious. Design aids like the UD-Culvert Excel workbook are very helpful when this is necessary.

Storm drains are sized to flow just full (i.e., as open channels using nearly the full capacity of the pipe). The design discharge is determined first using the rational method as previously discussed, then the Manning's equation is used (with  $S_f = S_o$ ) to determine the required pipe size. For circular pipes,

$$D_r = \left[ \frac{2.16nQ}{\sqrt{S_o}} \right]^{3/8} \quad \text{Equation 7-49}$$

Where  $D_r$  is the minimum size pipe required to convey the design flow and  $Q$  is peak design flow. However, the pipe diameter that should be used in the field is the next standard pipe size larger than  $D_r$ .

The typical process proceeds as follows. Initial storm drain pipe sizing is performed first using the rational method in conjunction with Manning's equation. The rational method is used to determine the peak discharge that storm drains must convey. The storm drain pipes are then initially sized using Manning's equation assuming uniform, steady flow at the peak. Finally, these initial pipe sizes are checked using the energy equation by accounting for all head losses. If the energy computations detect surcharging at manholes or inlets, the pipe sizes are increased.

#### 4.4.2 Energy Grade Line and Head Losses

Head losses must be accounted for in the design of storm drains in order to find the energy grade line (EGL) and the hydraulic grade line (HGL) at any point in the system. The FHWA (1996) gives the following equation as the basis for calculating the head losses at inlets, manholes, and junctions ( $h_{LM}$ , in feet):

$$h_{LM} = K_o C_D C_d C_Q C_p C_B \left( \frac{V_o^2}{2g} \right) \quad \text{Equation 7-50}$$

Where:

$K_o$  = initial loss coefficient

$V_o$  = velocity in the outflow pipe (ft/sec)

$g$  = gravitational acceleration (32.2 ft/sec<sup>2</sup>)

$C_D$ ,  $C_d$ ,  $C_Q$ ,  $C_p$ , and  $C_B$  = correction factors for pipe size, flow depth, relative flow, plunging flow and benching.

However, this equation is valid only if the water level in the receiving inlet, junction, or manhole is above the invert of the incoming pipe. Otherwise, another protocol has to be used to calculate head losses at manholes. What follows is a modified FHWA procedure that engineers can use to calculate the head losses and the EGL along any point in a storm drain system.

The EGL represents the energy slope between the two adjacent manholes in a storm drain system. A manhole may have multiple incoming storm drains, but only one outgoing drain. Each drain and its downstream and upstream manholes form a pipe-manhole unit. The entire storm drain system can be decomposed into a series of pipe-manhole units that satisfy the energy conservation principle. The computation of the EGL does this by repeating the energy-balancing process for each pipe-manhole unit.

As illustrated in Figure 7-13, a pipe-manhole unit has four distinctive sections. Section 1 is inside the downstream manhole, Section 2 is the point at the exit of the pipe just upstream of this manhole, Section 3 is just inside the upstream end of the pipe at the upstream manhole, and Section 4 is inside the upstream manhole. For each pipe-manhole unit, the head losses are determined separately in two parts as:

- Friction losses through the pipe, and
- Junction losses at the manhole.

The discussion that follows explains how to apply energy balancing to calculate the EGL through each pipe-manhole unit.

##### Losses at the Downstream Manhole, Section 1 to Section 2

The continuity of the EGL is determined between the flow conditions at centerline of the downstream manhole, Section 1, and the exit of the incoming pipe, Section 2, as illustrated in Figure 7-13 and idealized EGL and HGL profiles in Figure 7-14.

At Section 2 there may be pipe-full flow, supercritical open channel flow, critical open channel flow, or subcritical open channel flow. If the pipe soffit at the exit is submerged, the EGL at the downstream manhole provides a tailwater condition; otherwise, the manhole drop can create a discontinuity in the EGL. Therefore, it is necessary to evaluate the two possibilities, namely:

$$E_2 = \max\left(\frac{V_2^2}{2g} + Y_2 + Z_2, E_1\right)$$

Equation 7-51

Where:

$E_2$  = EGL at Section 2 (ft)

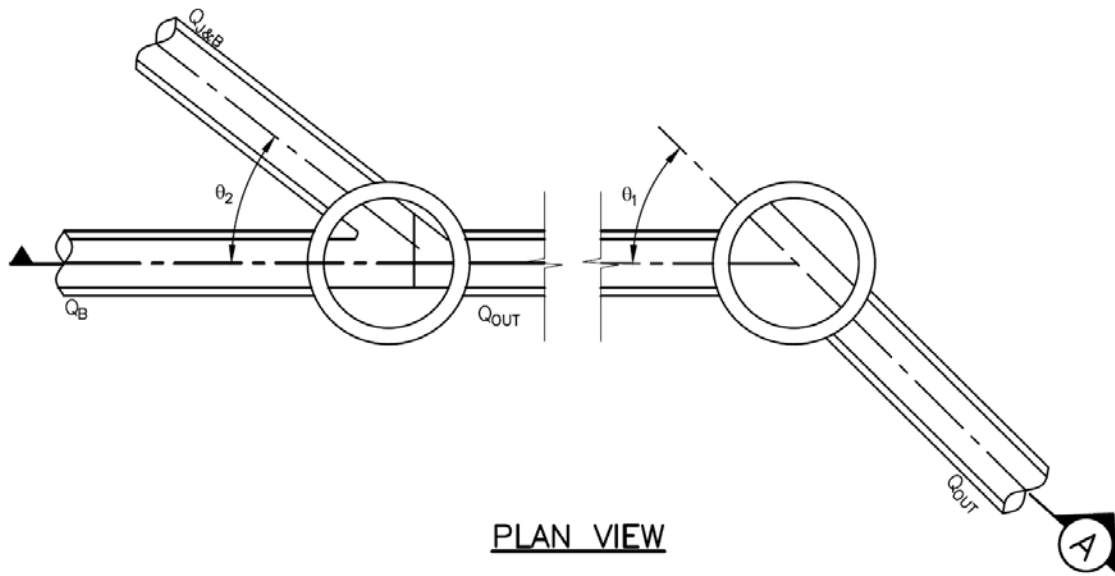
$V_2$  = pipe exit velocity (ft/s)

$Y_2$  = flow depth in feet at the pipe exit (ft)

$Z_2$  = invert elevation in feet at the pipe exit (ft)

$E_1$  = tailwater at Section 1 (ft)

Equation 7-51 states that the highest EGL value shall be considered as the downstream condition. If the manhole drop dictates the flow condition at Section 2, a discontinuity is introduced into the EGL.



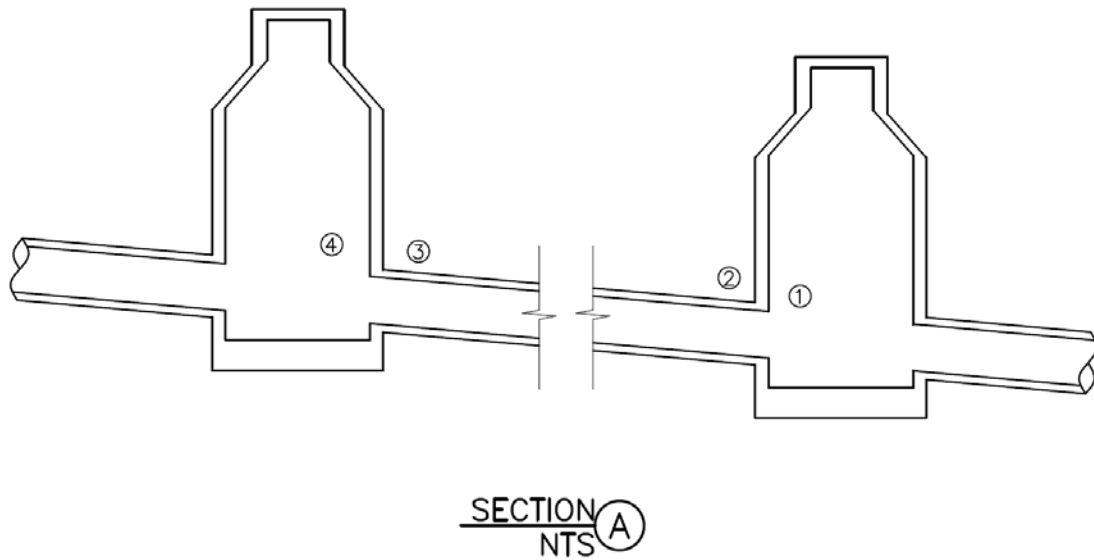


Figure 7-11. A pipe-manhole unit

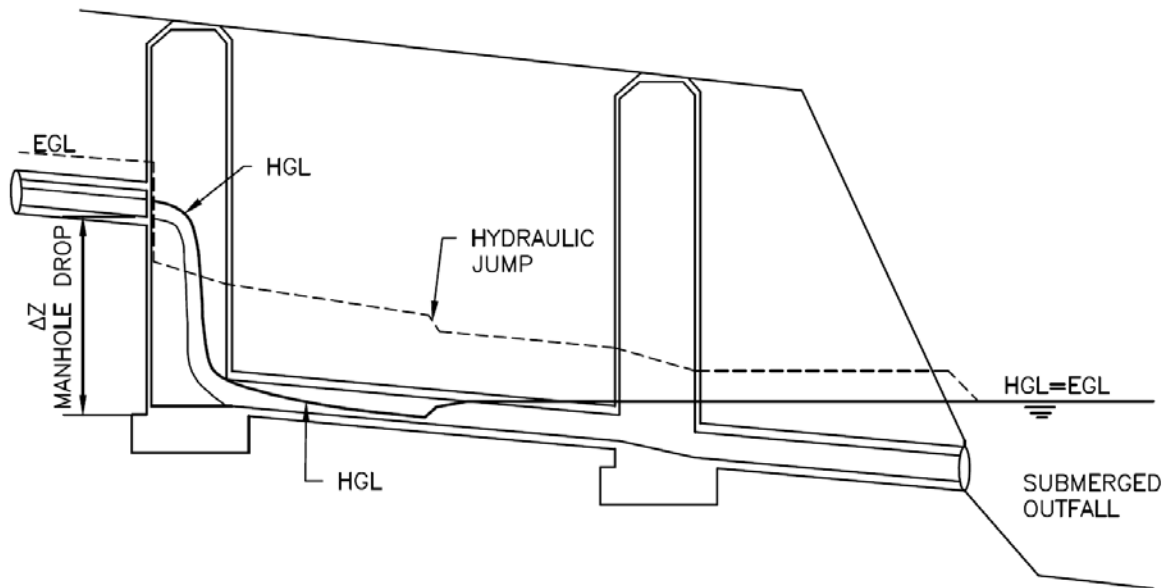


Figure 7-12. Hydraulic and energy grade lines

### Losses in the Pipe, Section 2 to Section 3

The continuity of the EGL within the pipe depends on the friction losses through the pipe. The flow in the pipe can be one condition or a combination of open channel flow, full flow, or pressurized (surcharge) flow.

When a free surface exists through the pipe length, open channel hydraulics apply to the backwater surface profile computations. The friction losses through the pipe are the primary head losses for the type of water surface profile in the pipe. For instance, the pipe carrying a subcritical flow may have an M-1 water surface profile if the water depth at the downstream manhole is greater than normal depth in the pipe or an M-2 water surface profile if the water depth in the downstream manhole is lower than normal depth. Under an alternate condition, the pipe carrying a supercritical flow may have an S-2 water surface profile if the pipe entering the downstream manhole is not submerged; otherwise, a hydraulic jump is possible within the pipe.

When the downstream pipe soffit is submerged to a degree that the entire pipe is under the HGL, the head loss for this full flow condition is estimated by pressure flow hydraulics.

When the downstream pipe soffit is slightly submerged, the downstream end of the pipe is surcharged, but the upstream end of the pipe can have open channel flow. The head loss through a surcharge flow depends on the flow regime. For a subcritical flow, the head loss is the sum of the friction losses for the full flow condition and for the open channel flow condition. For a supercritical flow, the head loss may involve a hydraulic jump. To resolve which condition governs, culvert hydraulic principles can be used under both inlet and outlet control conditions and the governing condition is the one that produces the highest HGL at the upstream manhole.

Having identified the type of flow in the pipe, the computation of friction losses begins with the determination of friction slope. The friction loss and energy balance are calculated as:

$$h_f = LS_f \quad \text{Equation 7-52}$$

$$E_3 = E_2 + \sum h_f \quad \text{Equation 7-53}$$

Where:

$h_f$  = friction loss (ft)

$L$  = length of pipe (ft)

$S_f$  = friction slope in the pipe (ft/ft)

$E_3$  = EGL at the upstream end of pipe (ft)

### Losses at the Upstream Manhole, Section 3 to Section 4

Additional losses may be introduced at the pipe entrance. The general formula to estimate the entrance loss is:

$$h_E = K_E \frac{V^2}{2g} \quad \text{Equation 7-54}$$

Where:

$h_E$  = entrance loss (ft)

$V$  = pipe-full velocity in the incoming pipe (ft/s)



$K_E$  = entrance loss coefficient between 0.2 to 0.5

In the modeling of pipe flow, the pipe entrance coefficients can be assumed to be part of the bend loss coefficient.

The energy principle between Sections 3 and 4 is determined by:

$$E_4 = E_3 + h_E \quad \text{Equation 7-55}$$

Where:

$E_4$  = EGL at Section 4 (ft)

### **Junction and Bend Losses at the Upstream Manhole, Section 4 to Section 1**

The analysis from Section 4 of the downstream pipe-manhole unit to Section 1 of the upstream pipe-manhole unit consists only of junction losses through the manhole. To maintain the conservation of energy through the manhole, the outgoing energy plus the energy losses at the manhole have to equal the incoming energy. Often a manhole is installed for the purpose of maintenance, deflection of the pipe alignment, change of the pipe size, and as a junction for incoming laterals. Although there are different causes for junction losses, they are typically considered as a minor loss in the computation of the EGL. These junction losses in the pipe system are determined solely by the local configuration and geometry and not by the length of the flow path through the manhole.

### **Bend/Deflection Losses**

The angle between the incoming pipe line and the centerline of the exiting main pipe line introduces a bend loss to the incoming pipe. Bend loss is estimated by:

$$h_b = K_b \frac{V^2}{2g} \quad \text{Equation 7-56}$$

Where:

$h_b$  = bend loss (ft)

$V$  = full flow velocity in the incoming pipe (ft/s)

$K_b$  = bend loss coefficient.

As shown in Figure 7-15 and Table 7-11, the value of  $K_b$  depends on the angle between the exiting pipe line and the existence of manhole bottom shaping. A shaped manhole bottom or a deflector guides the flow and reduces bend loss. Figure 7-16 illustrates four cross-section options for the shaping of a manhole bottom. Only sections “c. Half” and “d. Full” can be considered for the purpose of using the bend loss coefficient for the curve on Figure 7-15 labeled as “Bend at Manhole, Curved or Shaped.”

Because a manhole may have multiple incoming pipes, Equation 7-56 should be applied to each incoming pipe based on its incoming angle, and then the energy principle between Sections 4 and 1 can be calculated as:

$$E_1 = E_4 + h_b \quad \text{Equation 7-57}$$

**Lateral Junction Losses**

In addition to the bend loss, the lateral junction loss is also introduced because of the added turbulence and eddies from the lateral incoming flows. The lateral junction loss is estimated as:

$$h_j = \frac{V_o^2}{2g} - K_j \frac{V_i^2}{2g} \quad \text{Equation 7-58}$$

Where:

$h_j$  = lateral loss (ft)

$V_o$  = full flow velocity in the outgoing pipe (ft/s)

$K_j$  = lateral loss coefficient

$V_i$  = full flow velocity in the incoming pipe (ft/s)

In modeling, a manhole can have multiple incoming pipes, one of which is the main (i.e., trunk) line, and one outgoing pipe. As shown in Table 7-11, the value of  $K_j$  is determined by the angle between the lateral incoming pipe line and the outgoing pipe line.

**Table 7-11. Bend loss and lateral loss coefficients (FHWA 2009)**

Angle in Degree	Bend Loss Coefficient for Curved Deflector in the Manhole	Bend Loss Coefficient for Non-shaping Manhole	Lateral Loss Coefficient on Main Line Pipe
Straight Through	0.05	0.05	Not Applicable
22.50	0.10	0.13	0.75
45.00	0.28	0.38	0.50
60.00	0.48	0.63	0.35
90.00	1.01	1.32	0.25

At a manhole, the engineer needs to identify the main incoming pipe line (the one that has the largest inflow rate) and determine the value of  $K_j$  for each lateral incoming pipe. To be conservative, the smallest  $K_j$  is recommended for Equation 7-58, and the lateral loss is to be added to the outfall of the incoming main line pipe as:

$$E_1 = E_4 + h_b + h_j \quad (h_j \text{ is applied to main pipe line only}) \quad \text{Equation 7-59}$$

The difference between the EGL and the HGL is the flow velocity head. The HGL at a manhole is calculated by:

$$H_1 = E_1 - \frac{V_o^2}{2g} \quad \text{Equation 7-60}$$

The energy loss between two manholes is defined as:

$$\Delta E = (E_1)_{upstream} - (E_1)_{downstream} \quad \text{Equation 7-61}$$

where  $\Delta E$  = energy loss between two manholes.  $\Delta E$  includes the friction loss, junction loss, bend loss, and manhole drop.

### Transitions

In addition to pipe-manhole unit losses, head losses in a storm pipe can occur due to a transition in the pipe itself, namely, gradual pipe expansion. Transition loss,  $h_{LE}$ , in feet, can be determined using:

$$h_{LE} = K_e \left( \frac{V_1^2}{2g} - \frac{V_2^2}{2g} \right) \quad \text{Equation 7-62}$$

where  $K_e$  is the expansion coefficient and subscripts 1 and 2 refer to upstream and downstream of the transition, respectively. The value of the expansion coefficient,  $K_e$ , may be taken from Table 7-12 for free surface flow conditions in which the angle of cone refers to the angle between the sides of the tapering section (see Figure 7-17).

**Table 7-12. Head loss expansion coefficients in non-pressure flow (FHWA 2009)**

$D_2/D_1$	Angle of Cone						
	10°	20°	30°	40°	50°	60°	70°
1.5	0.17	0.40	1.06	1.21	1.14	1.07	1.00
3	0.17	0.40	.86	1.02	1.06	1.04	1.00

Head losses due to gradual pipe contraction,  $h_{LC}$ , in feet, are determined using:

$$h_{LC} = K_c \left( \frac{V_2^2}{2g} - \frac{V_1^2}{2g} \right) \quad \text{Equation 7-63}$$

where  $K_c$  = contraction coefficient. Typically,  $K_c = 0.5$  provides reasonable results.

The USDCM does not recommend pipe contractions for storm pipes.

### Curved Pipes

Head losses due to curved pipes (sometimes called radius pipe),  $h_{Lr}$ , in feet, can be determined using:

$$h_{Lr} = K_r \frac{V^2}{2g} \quad \text{Equation 7-64}$$

where  $K_r$  = curved pipe coefficient from Figure 7-15.

### Losses at Storm Drain Exit

Head losses at storm drain outlets,  $h_{LO}$ , are determined using:

$$h_{LO} = \frac{V_o^2}{2g} - \frac{V_d^2}{2g} \quad \text{Equation 7-65}$$

where  $V_o$  is the velocity in the outlet pipe (ft/s), and  $V_d$  is the velocity in the downstream channel (ft/s). When the storm drain discharges into a reservoir or as a free jet (no downstream tailwater),  $V_d = 0$  and one full velocity head is lost at the exit.

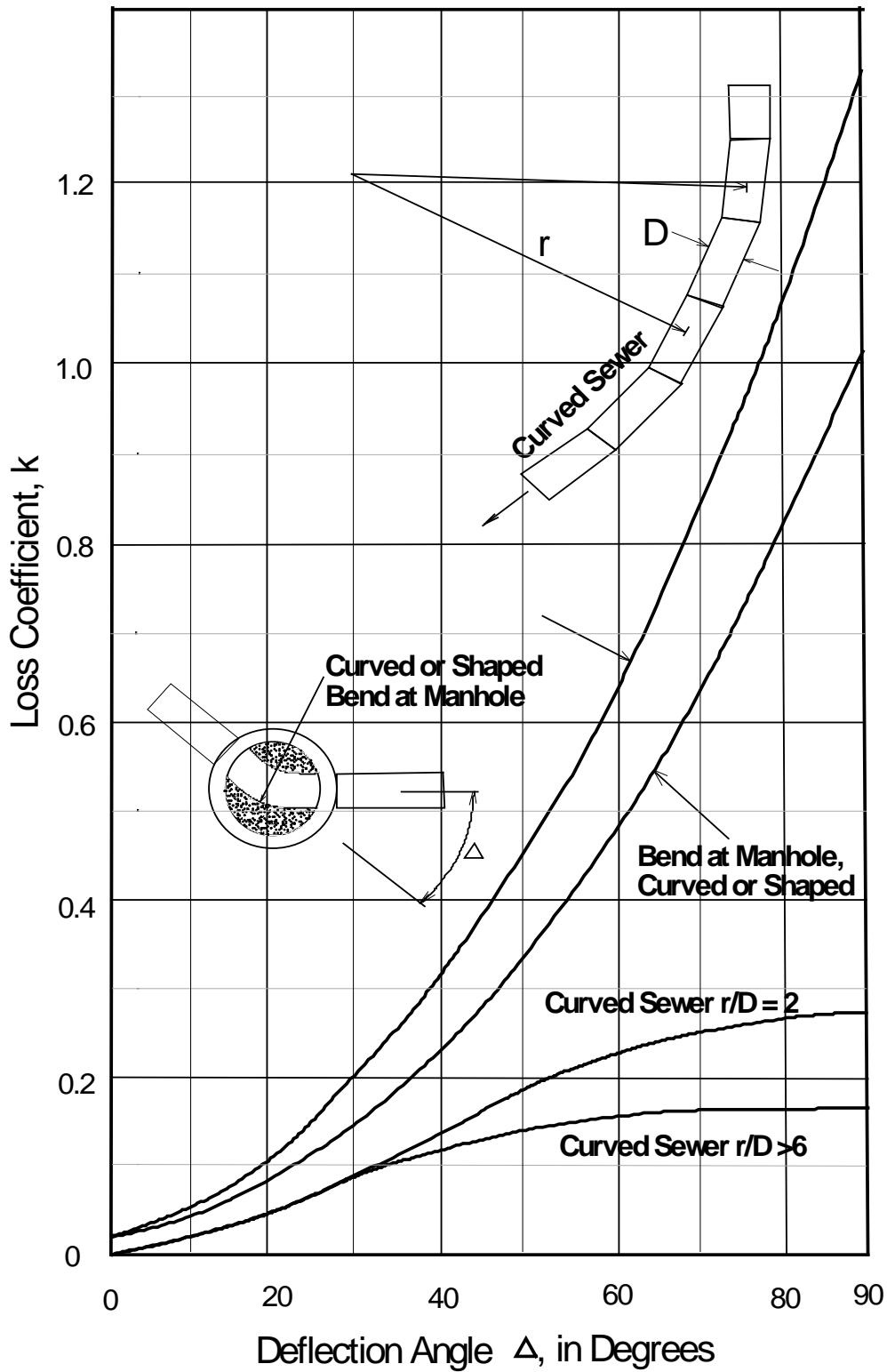
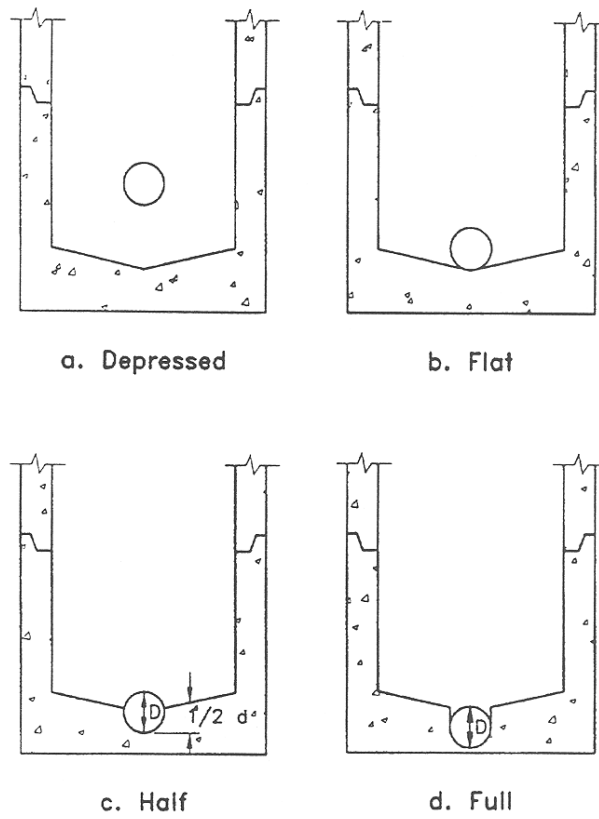
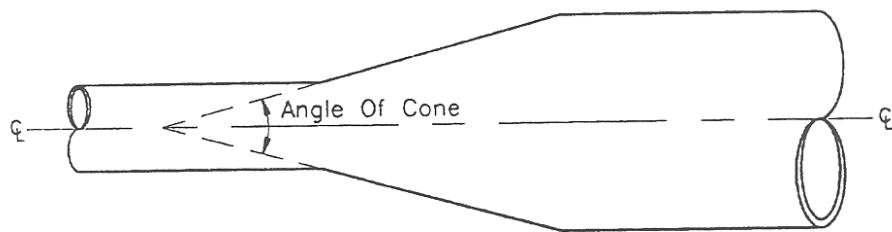


Figure 7-13. Bend loss coefficients



**Figure 7-14. Manhole benching methods**



**Figure 7-15. Angle of cone for pipe diameter changes**

## 5.0 UD-Inlet Design Workbook

The UD-Inlet design workbook provides quick solutions for many of the street capacity and inlet performance computations described in this chapter. A brief summary of each worksheet of the workbook is provided below. Note that some of the symbols and nomenclature in the worksheets do not correspond exactly with the nomenclature of the text. The text and the worksheets are computationally equivalent. An example problem using UD-Inlet is provided in section 6.0 of this chapter.

- The *Q-Peak* tab calculates the peak discharge for the inlet tributary area based on the rational method for the minor and major storm events. Alternatively, the user can enter a known flow. Information from this tab is exported to the *Inlet Management* tab.
- The *Inlet Management* tab imports information from the *Q-Peak* tab and *Inlet [#]* tabs and can be used to connect inlets in series so that bypass flow from an upstream inlet is added to flow calculated for the next downstream inlet. This tab can also be used to modify design information imported from the *Q-Peak* tab.
- *Inlet [#]* tabs are created each time the user exports information from the *Q-Peak* tab to the *Inlet Management* tab. The *Inlet [#]* tabs calculate allowable half-street capacity based on allowable depth and allowable spread for the minor and major storm events. This is also where the user selects an inlet type and calculates the capacity of that inlet.
- The *Inlet Pictures* tab contains a library of photographs of the various types of inlets contained in the worksheet and referenced in this chapter.

## 6.0 Examples

### 6.1 Example—Triangular Gutter Capacity

A triangular gutter has a longitudinal slope of 1%, cross slope of 2%, and a curb depth of 6 inches. Determine the flow rate and flow depth if the spread is limited to 9 feet.

Using Equation 7-1 the flow rate is calculated as:

$$Q = \frac{0.56}{n} S_x^{5/3} S_o^{1/2} T^{8/3}$$

$$Q = \frac{0.56}{0.016} (0.02^{5/3}) (0.01^{1/2}) (9^{8/3}) = 1.81 \text{ cfs}$$

The flow depth can be found using Equation 7-2:

$$y = (9.0)(0.02) = 0.18 \text{ ft}$$

Note that the computed flow depth is less than the curb height of 6 inches (0.5 feet). If it was not, the spread and associated flow rate would need to be reduced.

## 6.2 Example—Composite Gutter Capacity

Determine the discharge in a composite gutter section if the allowable spread is 9 feet, the gutter width is 2 feet, and the vertical depth between gutter lip and gutter is 2.0 inches. The street's longitudinal slope is 1%, the cross slope is 2%, and the curb height is 6 inches.

First determine the gutter cross slope,  $S_w$ , using Equation 7-8:

$$S_w = S_x + \frac{a}{W}$$

$$S_w = 0.02 + \frac{\frac{2}{12} - 2(0.02)}{2} = 0.083 \text{ feet}$$

The flow in the street is found using Equation 7-1:

$$Q_x = \frac{0.56}{n} S_x^{5/3} S_o^{1/2} T^{8/3}$$

$$Q_x = \frac{0.56}{0.016} 0.02^{5/3} 0.01^{1/2} 7^{8/3} = 0.92 \text{ cfs}$$

From Equation 7-7 the ratio of gutter flow to total flow ( $Q_w/Q$ ) is represented by  $E_o$ .

$$E_o = \frac{1}{1 + \frac{S_w/S_x}{\left[1 + \frac{S_w/S_x}{(T/W) - 1}\right]^{8/3} - 1}}$$

$$E_o = \frac{1}{1 + \frac{0.083/0.02}{\left[1 + \frac{0.083/0.02}{(9/2) - 1}\right]^{8/3} - 1}} = 0.63$$

Now the theoretical flow rate can be found using Equation 7-6:

$$Q = \frac{Q_x}{1 - E_o}$$

$$Q = \frac{0.92}{1 - 0.63} = 2.49 \text{ cfs}$$



Then by using Equation 7-9 the computed flow depth is:

$$y = a + TS_x$$

$$y = [0.1667 - 2(0.02)] + 9(0.02) = 0.31 \text{ feet}$$

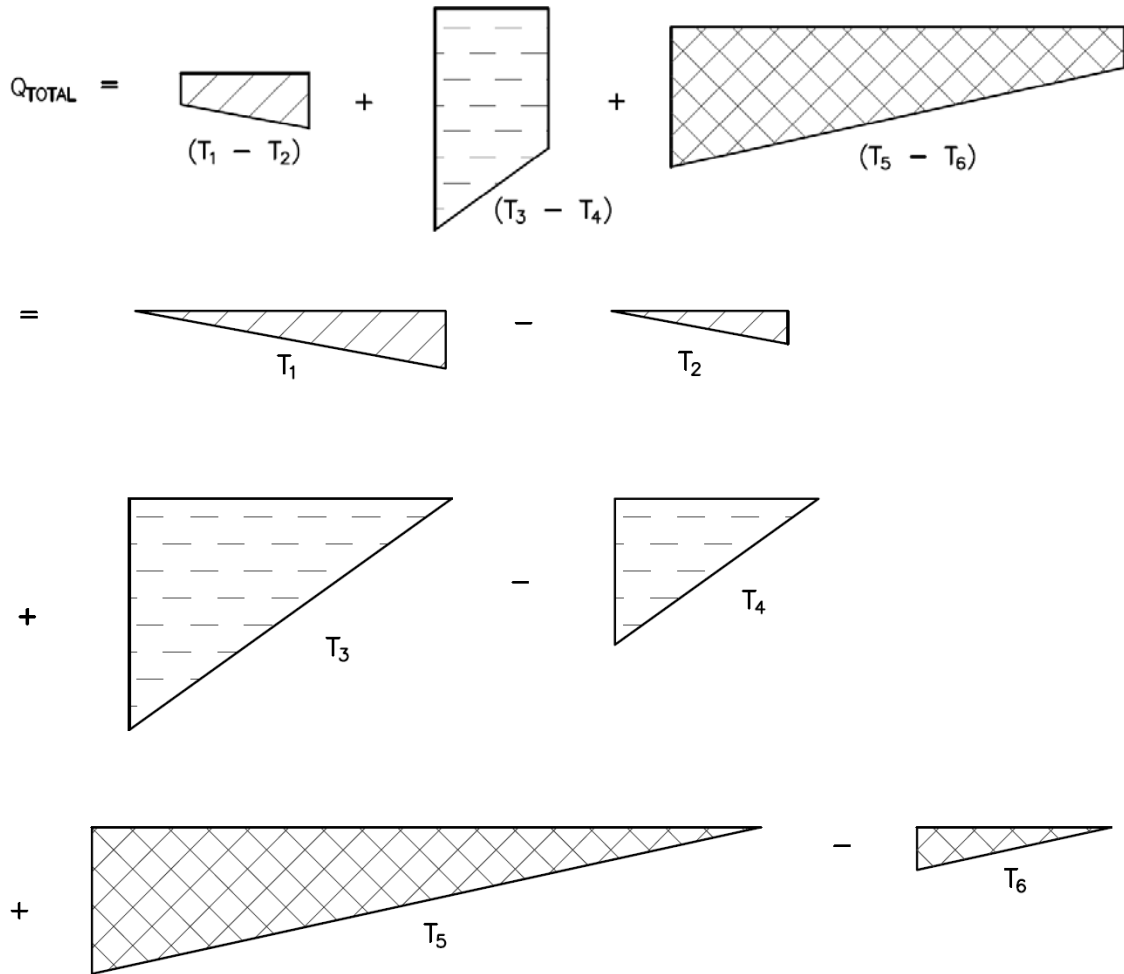
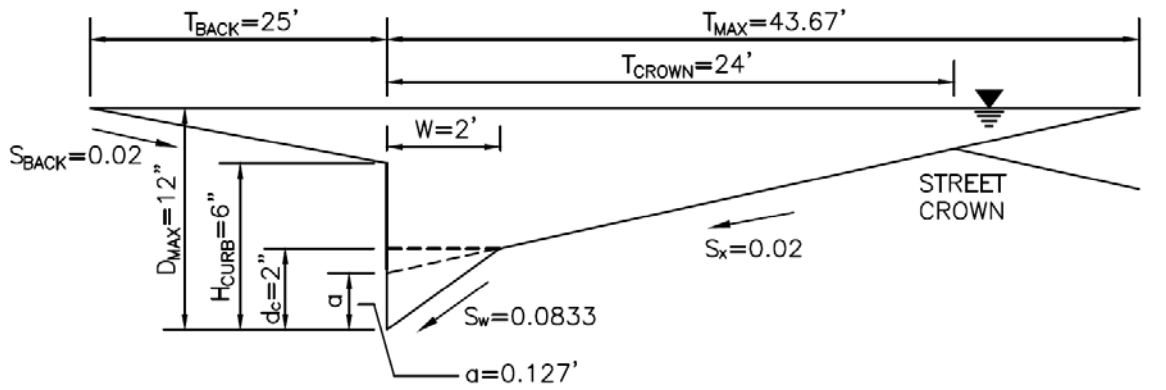
Note that the computed flow depth is less than the curb height of 6 inches.

### 6.3 Example—Composite Gutter Capacity – Major Storm Event

Determine the local street capacity of a composite gutter street section if the allowable depth is 12 inches. Assume there is ponding on the crown of the road and the encroachment has extended onto the 10-foot wide sidewalk behind the curb (sloping toward the curb at 2%). The street's longitudinal slope is 1% and the cross slope is 2%. The gutter width is 2 feet, the vertical distance between the gutter lip and flowline is 2 inches, and the height of the curb is 6 inches. The distance from the gutter flowline to the street crown is 24 feet. Use a Manning's coefficient (n) of 0.013 for concrete and 0.016 for asphalt. It should be noted that at a 12-inch depth, the sidewalk behind the curb would not contain the flow. This example assumes that flow is contained by a vertical wall at the back of the walk. From a standpoint of public safety, it is of great importance to ensure that flow is contained within the right-of-way for the full length of the project. For this reason, the allowable depth of flow is typically determined by the physical constraints behind the curb rather than maximum depth criteria.

The total flow can be found by dividing the cross section into six right triangles as shown below and calculating the flow through each section using Equation 7-1.

$$Q = \frac{0.56}{n} S_x^{5/3} S_o^{1/2} T^{8/3}$$



After flow in each of the 6 triangles has been determined, add and subtract the flow in each area as shown in the above figure.

$$Q = Q_{T1} - Q_{T2} + Q_{T3} - Q_{T4} + Q_{T5} - Q_{T6}$$

$$Q_{T1} = \frac{0.56}{0.013} (0.02^{5/3}) (0.01^{1/2}) (25^{8/3}) = 33.9 \text{ cfs}$$

$$Q_{T2} = \frac{0.56}{0.013} (0.02^{5/3}) (0.01^{1/2}) (15^{8/3}) = 8.86 \text{ cfs}$$

$$Q_{T3} = \frac{0.56}{0.013} (0.0833^{5/3}) (0.01^{1/2}) (12^{8/3}) = 51.7 \text{ cfs}$$

$$Q_{T4} = \frac{0.56}{0.013} (0.0833^{5/3}) (0.01^{1/2}) (10^{8/3}) = 31.8 \text{ cfs}$$

(Solve for T using equation 7-9)

$$Q_{T5} = \frac{0.56}{0.016} (0.02^{5/3}) (0.01^{1/2}) (41.7^{8/3}) = 107.8 \text{ cfs}$$

$$Q_{T6} = \frac{0.56}{0.016} (0.02^{5/3}) (0.01^{1/2}) (19.7^{8/3}) = 14.6 \text{ cfs}$$

Therefore by combining the above calculations the total flow can be calculated as:

$$Q = Q_{T1} - Q_{T2} + Q_{T3} - Q_{T4} + Q_{T5} - Q_{T6} = 138 \text{ cfs}$$

Note: UD-Inlet.xls uses HEC-22 methodology to solve this problem and will provide a slightly different answer.

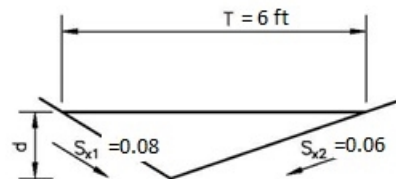
### 6.4 Example—V-Shaped Swale Capacity

Determine the maximum discharge and depth of flow in a V-shaped, roadside grass swale with side slopes of 8% and 6%, a longitudinal slope of 2% and a total width of 6 feet.

The adjusted slope,  $S_x$ , is determined using Equation 7-13:

$$S_x = \frac{S_{x1} S_{x2}}{S_{x1} + S_{x2}}$$

$$S_x = \frac{(0.08)(0.06)}{0.08 + 0.06} = 0.034$$



From Equation 7-1, the flow through the swale is computed:

$$Q = \frac{0.56}{n} S_x^{5/3} S_o^{1/2} T^{8/3}$$

$$Q = \frac{0.56}{0.03} 0.034^{5/3} 0.02^{1/2} 6^{8/3} = 1.12 \text{ cfs}$$

Using Equation 7-2 the flow depth is calculated as:

$$y = TS_x$$

$$y = 6(0.034) = 0.2 \text{ feet}$$

### 6.5 Example—V-Shaped Swale Design

Design a V-shaped swale to convey a flow of 1.8 cfs. The available swale top width is 8 feet, the longitudinal slope is 1%, and the Manning's roughness factor is 0.16. Determine the cross slopes and the depth of the swale.

Solving Equation 7-1 for  $S_x$  (i.e., average side slope) yields:

$$S_x = \left[ \frac{Qn}{0.56S_o^{1/2}T^{8/3}} \right]^{3/5}$$

$$S_x = \left[ \frac{(1.8)0.016}{0.56(0.01)^{1/2}8^{8/3}} \right]^{3/5} = 0.024 \text{ ft/ft}$$

Now Equation 7-13 is used to solve for the actual cross slope assuming  $S_{x1} = S_{x2}$ , Equation 7-13 can be rewritten and solved for  $S_{x1}$ :

$$S = 2S_x = 2(0.024) = 0.048 \text{ ft/ft}$$

Then using Equation 7-2 yields a flow depth,  $y$ , of:

$$y = TS_x = (0.024)(8) = 0.19 \text{ feet}$$

The swale is 8-feet wide with right and left side slopes of 0.048 ft/ft and a flow depth of 0.19 feet.

### 6.6 Example—Grate Inlet Capacity

Determine the efficiency of a CDOT Type C Standard Grate ( $W = 2$  feet and  $L = 2$  feet) when placed in a composite gutter section with a 2-foot concrete gutter that has a 2-inch drop between the gutter lip and gutter flowline. The street cross slope is 2% and the longitudinal slope of 1%. The flow in the gutter is 2.5 cfs with a spread of 8.5 feet.

Using Equation 7-7, determine the ratio of gutter flow to total flow ( $Q_w/Q$ ) (represented by  $E_o$ ):

$$E_o = \frac{1}{1 + \frac{S_w / S_x}{\left[1 + \frac{S_w / S_x}{(T/W) - 1}\right]^{8/3} - 1}}$$

$$E_o = \frac{1}{1 + \frac{0.083/0.02}{\left[1 + \frac{0.083/0.02}{(8.5/2) - 1}\right]^{8/3} - 1}} = 0.66$$

Solve Equation 7-6 for  $Q_x$  to determine the flow in the section outside of the depressed gutter:

$$Q_x = Q(1 - E_o) = 2.5(1 - 0.66) = 0.85 \text{ cfs}$$

The flow in the dressed gutter section is determined by subtracting this value from the total flow:

$$Q_w = 2.5 - 0.85 = 1.65 \text{ cfs}$$

Next, find the flow area using Equation 7-10 and velocity using the continuity equation  $V = Q/A$ .

$$A = \frac{S_x T^2 + aW}{2}$$

$$A = \frac{0.02(8.5^2) + 0.127(2)}{2} = 0.85 \text{ ft}^2$$

$$V = \frac{Q}{A} = \frac{2.5}{0.85} = 2.94 \text{ fps}$$

The splash-over velocity is determined from Equation 7-20:

$$V_o = \alpha + \beta L_e - \gamma L_e^2 + \eta L_e^3$$

Where:

$V_o$  = splash-over velocity (ft/sec)

$L_e$  = effective length of grate inlet (ft)

$\alpha, \beta, \gamma, \eta$  = constants from Table 7-6

$$V_o = 2.22 + 4.03(2) - 0.65(2^2) + 0.06(2^3) = 8.16 \text{ fps}$$

From Equation 7-19, the ratio of the frontal flow intercepted by the inlet to total frontal flow,  $R_f$ , is determined by:

$$R_f = \frac{Q_{wi}}{Q_w} = 1.0 - 0.09(V - V_o) \text{ for } V \geq V_o, \text{ otherwise } R_f = 1.0$$

$V \geq V_o$  in this example, therefore  $R_f = 1.0$

Using Equation 7-21, the side-flow capture efficiency is calculated as:

$$R_x = \frac{1}{1 + \frac{0.15V^{1.8}}{S_x L^{2.3}}}$$

$$R_x = \frac{1}{1 + \frac{0.15(2.94)^{1.8}}{(0.02)(2)^{2.3}}} = 0.086$$

Finally, the overall capture efficiency,  $E$ , is calculated using Equation 7-22:

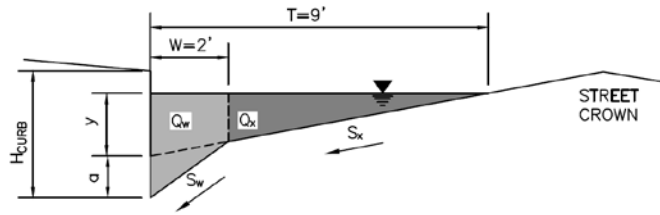
$$E = R_f(Q_w/Q) + R_x(Q_x/Q)$$

$$E = 1(1.64/2.5) + 0.086(0.86/2.5) = 0.69 \text{ (69\%)}$$

### 6.7 Example—Curb-Opening Inlet Capacity

Determine the amount of flow that will be captured by a 6-foot-long curb-opening inlet placed in the composite gutter described in Example Problem 6.2.

Equations 7-25 and 7-26 are used to determine the equivalent slope and the length of inlet required to capture 100% of the gutter flow.



First Equation 7-26 is used to calculate the equivalent cross slope,  $S_e$ .

$$S_e = S_x + \frac{(a + a_{local})}{W} E_o$$

$$S_e = 0.02 + \frac{(0.127 + 0)}{2} (0.63) = 0.060$$

The inlet length required to capture 100% of the gutter flow,  $L_T$ , is found using Equation 7-25.

$$L_T = 0.38Q^{0.51} S_L^{0.058} \left( \frac{1}{nS_e} \right)^{0.46}$$

$$L_T = 0.38(2.49)^{0.51} (0.01)^{0.058} \left( \frac{1}{0.016(0.06)} \right)^{0.46} = 11.32 \text{ feet}$$

Then, by Equation 7-23 the efficiency,  $E$ , of the curb inlet can be calculated.

$$E = 1 - \left[ 1 - \left( \frac{L}{L_T} \right) \right]^{1.8} \text{ for } L < L_T$$

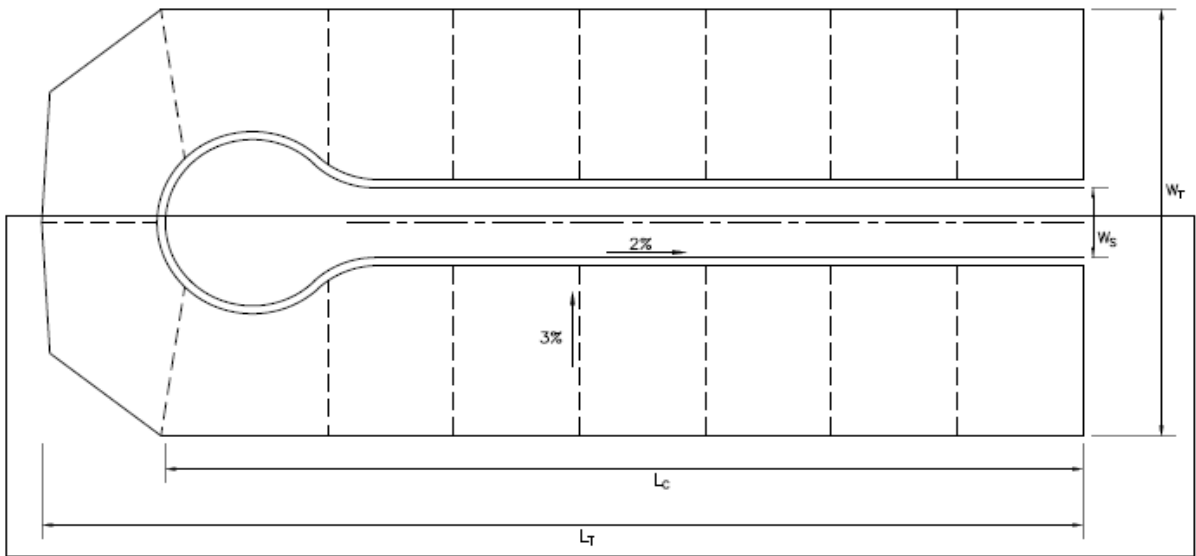
$$E = 1 - \left[ 1 - \left( \frac{6}{11.32} \right) \right]^{1.8} = 0.74 \text{ (74\%)}$$

The flow intercepted by the curb-opening inlet is calculated as follows:

$$Q_i = EQ = (0.74)(2.49) = 1.84 \text{ cfs}$$

### 6.8 Example—Design of a Network of Inlets Using UD-Inlet

Determine the number of CDOT Type R curb inlets needed to maintain allowable street flow for the 5-yr and 100-year storm events for each side of the street as shown in the below figure. The area can be described as a 4.8-acre residential development in Denver with  $L_T = 711$  ft, channel length  $L_C = 637$  ft,  $W_T = 310$  ft, and  $W_S = 30$  ft. Each lot is 0.25 acres. The development has imperviousness  $I=75\%$  and type C soil. The channel slope is 2% and the overland slope is 3%. All flows must be contained within the street and gutter section (i.e., no flow behind the curb). Additionally, the flow spread for the minor storm shall not exceed 9 ft.



The tributary area to be used is half of the total development ( $A = 2.4$  acre). Based on the dimensions of the lot sizes, the overland flow length is 136 ft. Use the Q-Peak tab of the UD-Inlet workbook to calculate the 5-year and 100-year peak flow for the upper portion of the tributary area. This requires approximation of the location of the most upstream inlet and calculation of the area tributary to this inlet. The following screenshot shows the Q-Peak input and output for the upper 0.7 acres of the tributary area. Based on the geometry of the development, this corresponds to a channel flow length of 157 feet.



DESIGN PEAK FLOW FOR ONE-HALF OF STREET  
 OR GRASS-LINED CHANNEL BY THE RATIONAL METHOD

Project: Criteria Manual Example

Show Details

Clear Worksheet

**Design Flow:** ONLY if already determined through other methods:  
 (local peak flow for 1/2 of street OR grass-lined channel): \*Q<sub>Known</sub> =  Minor Storm  Major Storm cfs

**\* If you enter values in Row 14, skip the rest of this sheet and proceed to sheet Q-Allow or Area Inlet.**

**Geographic Information:** (Enter data in the blue cells):

Site Type:

 Site is Urban  
 Site is Non-Urban

Flows Developed For:

 Street Inlets  
 Area Inlets in a Median

Subcatchment Area =	0.70	Acres
Percent Imperviousness =	75.0	%
NRCS Soil Type =	C	A, B, C, or D

Slope (ft/ft)	0.030	Length (ft)	136
Overland Flow =			
Gutter Flow =	0.020	157	

**Rainfall Information:** Intensity I (inch/hr) =  $C_1 * P_1 / (C_2 + T_c)^{C_3}$

	Minor Storm	Major Storm	
Design Storm Return Period, T <sub>r</sub> =	5	100	years
Return Period One-Hour Precipitation, P <sub>1</sub> =	1.35	2.61	inches
C <sub>1</sub> =	28.5	28.5	
C <sub>2</sub> =	10.0	10.0	
C <sub>3</sub> =	0.786	0.786	
User-Defined Storm Runoff Coefficient (leave this blank to accept a calculated value), C =			
User-Defined 5-yr. Runoff Coefficient (leave this blank to accept a calculated value), C <sub>5</sub> =			
Bypass (Carry-Over) Flow from upstream Subcatchments, Q <sub>b</sub> =	0.0	0.0	cfs
<b>Total Design Peak Flow, Q =</b>	<b>2.1</b>	<b>4.8</b>	<b>cfs</b>

←←← FILL IN THIS SECTION OR...  
 ←←← FILL IN THE SECTIONS BELOW.

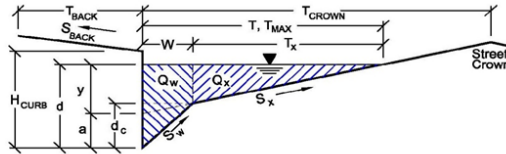
The *Q-Peak* inlet calculates the 5-year and 100-year peak flow based on the estimated sub-catchment area to the first inlet, percent imperviousness, soil type, appropriate time of concentration calculations, as well as location-specific rainfall information and runoff coefficients. For this problem, the 5-year flow is 2.1 cfs and the 100-year flow is 4.8 cfs. Alternatively, the user could enter known flows in this tab. Once the flows have been calculated, press the “Add Results to New Inlet” button. This adds a new inlet to the *Inlet Management* tab and opens a new tab for calculation of both the flow spread and depth in the street and the design of the receiving inlet.

On the inlet tab, enter the geometry of half of the street section. Use the requirements stated in the problem statement for the allowable spread and depth of flow. This section indicates the maximum street flow for the minor and major storm events based on allowable spread and depth criteria. If the allowable street flow is less than the flow calculated on the *Q-Peak* tab, reduce the area and associated channel length on the *Q-Peak* tab. For this example, neither flow depth nor flow spread exceed criteria. See the screenshot below.

**ALLOWABLE CAPACITY FOR ONE-HALF OF STREET (Minor & Major Storm)**

(Based on Regulated Criteria for Maximum Allowable Flow Depth and Spread)

Project: \_\_\_\_\_ Enter Your Project Name Here  
 Inlet ID: \_\_\_\_\_



Show Details  
 Clear Worksheet

**Gutter Geometry (Enter data in the blue cells)**

Maximum Allowable Width for Spread Behind Curb  
 Side Slope Behind Curb (leave blank for no conveyance credit behind curb)  
 Manning's Roughness Behind Curb (typically between 0.012 and 0.020)

Height of Curb at Gutter Flow Line  
 Distance from Curb Face to Street Crown  
 Gutter Width  
 Street Transverse Slope  
 Gutter Cross Slope (typically 2 inches over 24 inches or 0.083 ft/ft)  
 Street Longitudinal Slope - Enter 0 for sump condition  
 Manning's Roughness for Street Section (typically between 0.012 and 0.020)

Max. Allowable Spread for Minor & Major Storm  
 Max. Allowable Depth at Gutter Flowline for Minor & Major Storm  
 Allow Flow Depth at Street Crown (leave blank for no)

**MINOR STORM Allowable Capacity is based on Spread Criterion**  
**MAJOR STORM Allowable Capacity is based on Spread Criterion**  
 Minor storm max. allowable capacity GOOD - greater than the design flow given on sheet 'Inlet Management'  
 Major storm max. allowable capacity GOOD - greater than the design flow given on sheet 'Inlet Management'

T <sub>BACK</sub> =	4.0	ft
S <sub>BACK</sub> =	0.020	ft/ft
n <sub>BACK</sub> =	0.012	
H <sub>CURB</sub> =	6.00	inches
T <sub>CROWN</sub> =	15.0	ft
W =	2.00	ft
S <sub>y</sub> =	0.020	ft/ft
S <sub>w</sub> =	0.083	ft/ft
S <sub>o</sub> =	0.020	ft/ft
n <sub>STREET</sub> =	0.016	

T <sub>MAX</sub> =	Minor Storm	Major Storm	ft
d <sub>MAX</sub> =	9.0	15.0	inches
	<input type="checkbox"/>	<input type="checkbox"/>	check = yes

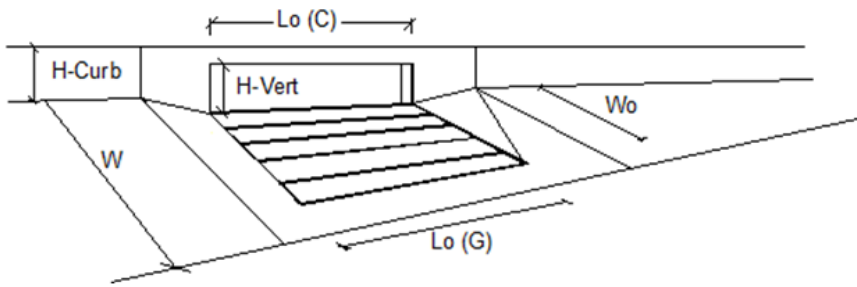
Optional: Set d-MAX to Limit V'd Product

Q <sub>allow</sub> =	Minor Storm	Major Storm	cfs
	3.5	11.3	

Bypass UDFCD Safety Factor

The screenshot below shows the inlet design specifications. Notice that there is bypass flow for both storms. These flows will be accounted for at the next (downstream) inlet. The length of the inlet or number of units can be increased to reduce bypass flow.

**INLET ON A CONTINUOUS GRADE**



Show Details  
 Reset Defaults  
 Clear Worksheet

**Design Information (Input)**

Type of Inlet: **CDOT Type R Curb Opening**

Type =	CDOT Type R Curb Opening	
a <sub>LOCAL</sub> =	3.0	3.0 inches
N <sub>o</sub> =	1	1
L <sub>o</sub> =	5.00	5.00 ft
W <sub>o</sub> =	N/A	N/A ft
C <sub>r-G</sub> =	N/A	N/A
C <sub>r-C</sub> =	0.10	0.10

**Street Hydraulics: OK - Q < maximum allowable from sheet 'Q-Allow'**

Total Inlet Interception Capacity	MINOR	MAJOR	cfs
	Q = 1.79	2.79	
Total Inlet Carry-Over Flow (flow bypassing inlet)	Q <sub>o</sub> = 0.3	2.0	cfs
Capture Percentage = Q <sub>a</sub> /Q <sub>o</sub> =	C% = 86	58	%

To add the next downstream inlet (Inlet 2), return to the *Q-Peak* tab and enter the same information for the next (downstream) tributary area as was required for Inlet 1. This information is automatically moved to the *Inlet management* tab when a new inlet is added. Prior to designing this inlet, ensure that bypass flows are added on the *Inlet management* tab. To do this, use the drop-down menu in the “Receive Bypass Flow from” row and select Inlet 1. The *Inlet Management* tab can also be used to adjust the subcatchment area and corresponding channel length to make adjustments as needed during design while maintaining a network of inlets that update when these changes are made. Changes made on the individual inlet tabs will also update on the *Inlet Management* tab. A screenshot of the *Inlet Management* tab is shown below.

Inlet Management

Worksheet Protected

	Delete	Delete	Delete
<b>INLET NAME</b>	Inlet 1	Inlet 2	Inlet 3
Inlet Application (Street or Area)	STREET	STREET	STREET
Hydraulic Condition	On Grade	On Grade	On Grade
Inlet Type	CDOT Type R Curb Opening	CDOT Type R Curb Opening	CDOT Type R Curb Opening

**USER-DEFINED INPUT** Show Input Details

		Inlet 1	Inlet 2
Receive Bypass Flow from:		Inlet 1	Inlet 2
Minor $Q_{Known}$ (cfs)			
Major $Q_{Known}$ (cfs)			
Minor Bypass Flow, $Q_b$ (cfs)	0.0	0.3	0.5
Major Bypass Flow, $Q_b$ (cfs)	0.0	2.0	4.2

**Watershed Characteristics**

Subcatchment Area (acres)	0.7	0.85	0.85
Percent Impervious	75	75	75
NRCS Soil Type	C	C	C

**Watershed Profile**

Overland Slope (ft/ft)	0.03	0.03	0.03
Overland Length (ft)	136	136	136
Channel Slope (ft/ft)	0.02	0.02	0.02
Channel Length (ft)	157	240	240

**Minor Storm Rainfall Input**

Design Storm Return Period, $T_r$ (years)	5	5	5
One-Hour Precipitation, $P_1$ (inches)	1.35	1.35	1.35

**Major Storm Rainfall Input**

Design Storm Return Period, $T_r$ (years)	100	100	100
One-Hour Precipitation, $P_1$ (inches)	2.61	2.61	2.61

**CALCULATED OUTPUT** Show Output Details

<b>Minor Total Design Peak Flow, Q</b>	<b>2.1</b>	<b>2.8</b>	<b>2.9</b>
<b>Major Total Design Peak Flow, Q</b>	<b>4.8</b>	<b>7.7</b>	<b>9.9</b>

The screenshot above shows that the selected tributary area of this development will require 3 CDOT Type R Curb inlets. This will ensure that the majority of the flows don't exceed the allowable depth or spread stated in the problem. The 4.8-acre development will require a total of six inlets, three on each side of the street.

## 7.0 References

- Akan, A.O. and R.J. Houghtalen. 2002. *Urban Hydrology, Hydraulics, and Water Quality*. Upper Saddle River, NJ: Prentice Hall. Forthcoming.
- Colorado State University (CSU). 2009. *Hydraulic Efficiency of Grate and Curb Inlets for Urban Storm Drainage*. Denver, CO: Urban Drainage and Flood Control District.
- Federal Highway Administration (FHWA). 1984. *Drainage of Highway Pavements*. Hydraulic Engineering Circular 12. McLean, VA: Federal Highway Administration.
- Federal Highway Administration (FHWA). 2009. *Urban Drainage Design Manual*. Hydraulic Engineering Circular 22. Washington, DC: Federal Highway Administration.
- Guo, J.C.Y. 1992. *Technical Manual for Computer Model UDSEWER for Storm Sewer System Design*. Denver, CO: Department of Civil Engineering, University of Colorado at Denver.
- Guo, J.C.Y. 1998a. Storm Sewer System Design and Flow Analysis Using the Personal Computer Model UDSEWER. Denver, CO: Urban Drainage and Flood Control District.
- Guo, J.C.Y. 1998b. *Street Hydraulics and Inlet Sizing Using the Computer Model UDINLET*. Denver, CO: Urban Drainage and Flood Control District.
- Guo, J.C.Y. 1999. *Storm Water System Design*. CE 5803, University of Colorado at Denver.
- Guo, J.C.Y. 2000a. Design of Grate Inlets with a Clogging Factor. *Advances in Environmental Research* 4(3)181-186.
- Guo, J.C.Y. 2000b. Street Storm Water Conveyance Capacity. *Journal of Irrigation and Drainage Engineering* 136(2)119-124.
- Wright-McLaughlin Engineers. 1969. *Urban Storm Drainage Criteria Manual*. Prepared for the Denver Regional Council of Governments. Denver, CO: Urban Drainage and Flood Control District.



# Chapter 8

## Open Channels

### Contents

<b>1.0</b>	<b>Introduction.....</b>	<b>1</b>
<b>2.0</b>	<b>Natural Stream Corridors.....</b>	<b>2</b>
2.1	Functions and benefits of Natural Streams.....	3
2.2	Natural Stream Corridors Prior to Urbanization .....	4
2.3	Urban Stream Corridors .....	5
2.3.1	Impacts and Constraints .....	5
2.3.2	Stream Degradation.....	5
<b>3.0</b>	<b>Preserving Natural Stream Corridors.....</b>	<b>7</b>
3.1	Preserve Natural Streams and Riparian Vegetation .....	7
3.2	Provide Ample Space for Stream and Floodplain .....	8
3.3	Manage Increased Urban Runoff .....	11
3.4	Monitor and Proactively Address Channel Instability .....	12
<b>4.0</b>	<b>Stream Restoration Principles .....</b>	<b>13</b>
4.1	Understand Existing Stream and Watershed Conditions.....	14
4.2	Apply Fluvial Geomorphology Principles to Manage Sediment Balance .....	17
4.2.1	Aggradation, Degradation, and Equilibrium .....	17
4.2.2	Dynamic Equilibrium and Threshold Principles in Stream Restoration .....	19
4.2.3	Support the Stream’s Natural Capacity to Sustain Itself.....	20
4.3	Establish Effective Cross-Sectional Shape.....	21
4.3.1	Maintaining Floodplain Function.....	21
4.3.2	Sizing of Bankfull Channel.....	22
4.3.3	Addressing Incised Channels .....	24
4.3.4	Floodplain Terraces.....	25
4.4	Maintain Natural Planform Geometry.....	28
4.5	Develop Grade Control Strategy to Manage Longitudinal Slope.....	30
4.6	Address Bank Stability.....	35
4.6.1	Bioengineering Techniques.....	35
4.6.2	Bank Protection Approaches.....	35
4.7	Enhance Streambank and Floodplain Vegetation.....	42
4.8	Evaluate Stream Hydraulics of over a Range of Flows .....	44
<b>5.0</b>	<b>Naturalized Channels.....</b>	<b>46</b>
5.1	Understand Existing Stream and Watershed Conditions.....	46
5.2	Apply Fluvial Geomorphology Principles to Manage Sediment Balance .....	47
5.3	Establish Effective Cross-Sectional Shape.....	47
5.4	Maintain Natural Planform Geometry.....	48
5.5	Develop Grade Control Strategy to Manage Longitudinal Slope.....	48
5.6	Address Bank Stability.....	49
5.7	Enhance Streambank and Floodplain Vegetation.....	49
5.8	Evaluate Stream Hydraulics over a Range of Flows .....	49
<b>6.0</b>	<b>Swales .....</b>	<b>50</b>
6.1	Design Criteria for Swales .....	51

6.1.1	Stability Charts .....	51
6.2	Grass Swales .....	52
6.2.1	Soil and Vegetation Properties.....	52
6.2.2	Construction.....	52
6.3	Soil Riprap and Void-Filled Riprap Swales.....	52
<b>7.0</b>	<b>Hydraulic Analysis.....</b>	<b>57</b>
7.1	Preliminary Channel Analysis.....	57
7.2	HEC-RAS Modeling.....	58
7.2.1	Cross Section Location .....	58
7.2.2	Cross Section Geometry .....	59
7.2.3	Roughness Coefficients .....	60
7.2.4	Design Storms.....	63
7.2.5	Output Variables.....	64
7.3	Evaluation of Erosion at Channel Bends.....	68
<b>8.0</b>	<b>Rock and Boulders.....</b>	<b>69</b>
8.1	Riprap Sizing .....	71
8.1.1	Mild Slope Conditions .....	71
8.1.2	Steep Slope Conditions .....	71
8.1.3	Design Safety Factor.....	72
8.2	Boulder and Riprap Specifications.....	72
8.2.1	Boulders.....	72
8.2.2	Soil Riprap.....	72
8.2.3	Void-Filled Riprap.....	73
<b>9.0</b>	<b>References.....</b>	<b>83</b>

## Tables

Table 8-1.	Maximum prudent values for natural channel hydraulic parameters.....	45
Table 8-2.	Minimum dimensions for naturalized channels <sup>1</sup> .....	48
Table 8-3.	Design parameters for naturalized channels .....	50
Table 8-4.	Summary of swale properties for stability chart reference .....	51
Table 8-5.	Recommended roughness values .....	61
Table 8-6.	Recommended retardance curve for vegetation in the Colorado Front Range .....	62
Table 8-7.	Comparison of void-filled riprap and soil riprap .....	70

## Figures

Figure 8-1.	Natural channel cross section illustrating floodplain terraces .....	2
Figure 8-2.	Example sand-bed stream.....	3
Figure 8-3.	Example upland channel.....	3
Figure 8-4.	Functions and benefits of natural stream corridors (Source: Arapahoe County).....	4
Figure 8-5.	Impacts of stream degradation (Source: Arapahoe County).....	6
Figure 8-6.	Fourmile Canyon Creek, September 2013 flood impacts and floodplain.....	10
Figure 8-7.	Importance of stream preservation zones .....	11
Figure 8-8.	Planform geometry of a meandering river system.....	15
Figure 8-9.	Lane's diagram .....	17
Figure 8-10.	Impact of channel geometry on velocity .....	22

Figure 8-11. Channel cross section with bankfull discharge illustration..... 23

Figure 8-12. Channel cross section with bankfull and flood prone water surfaces (Rosgen 1996)..... 25

Figure 8-13. Creating floodplain terrace in narrow corridor ..... 27

Figure 8-14. Riffle-pool stream form ..... 29

Figure 8-15. Example of meandering single-thread channel form (Courtesy: Wenk and Associates)..... 30

Figure 8-16. Full width grade control structures ..... 32

Figure 8-17. Bankfull channel grade control structures ..... 33

Figure 8-18. Example low-flow channel bank protection treatments..... 36

Figure 8-19A. Example bank protection treatments for steep eroded banks..... 39

Figure 8-19B. Example bank protection treatments for steep eroded banks ..... 40

Figure 8-20. Sample soil lift section..... 41

Figure 8-21. Typical naturalized channel geometry ..... 47

Figure 8-22. Swale stability chart; 2- to 4-foot bottom width and side slopes between 5:1 and 10:1 ..... 53

Figure 8-23. Swale stability chart: 2- to 4-foot bottom width and 10:1 (or flatter) side slopes..... 54

Figure 8-24. Swale stability chart: greater than 4-foot bottom width and side slopes between 5:1 and 10:1 ..... 55

Figure 8-25. Swale stability chart: greater than 4-foot bottom width and 10:1 (or flatter) side slopes ..... 56

Figure 8-26. Example of HEC-RAS cross section placement and alignment ..... 59

Figure 8-27. HEC-RAS cross section definitions..... 60

Figure 8-28. Manning's roughness in vegetated channels ..... 62

Figure 8-29. Example HEC-RAS tabular output for individual cross section..... 65

Figure 8-30. Example HEC-RAS tabular output for flow distribution at individual cross section ..... 66

Figure 8-31. Example HEC-RAS cross section with velocity distribution ..... 67

Figure 8-32. Example HEC-RAS general profile plot of shear stress ..... 68

Figure 8-33. Small rock of void-filled riprap becomes “wedged in” under larger rock ..... 73

Figure 8-34. Riprap and soil riprap placement and gradation (part 1 of 3) ..... 76

Figure 8-34. Riprap and soil riprap placement and gradation (part 2 of 3) ..... 77

Figure 8-34. Riprap and soil riprap placement and gradation (part 3 of 3) ..... 78

Figure 8-35. Void-filled riprap placement and gradation (part 1 of 3)..... 79

Figure 8-35. Void-filled riprap placement and gradation (part 2 of 3)..... 80

Figure 8-35. Void-filled riprap placement and gradation (part 3 of 3)..... 81

Figure 8-36. Sample grouted boulder section..... 82





## 1.0 Introduction

This chapter focuses on the preservation, enhancement, and restoration of stream corridors as well as the design of constructed channels and swales using natural concepts. Guidance is provided for the hydraulic evaluation of open channels and the design of measures to improve the stability and health of stream systems. These measures include maintaining or establishing an effective planimetric channel form, cross sectional shape, and longitudinal slope; implementing grade control and bank protection; and establishing and maintaining a favorable mix of riparian vegetation. See the *Hydraulic Structures* chapter for various types of structures with an open channels and the *Stream Access and Recreational Channels* chapter for criteria related to the design of shared use paths adjacent to streams and criteria for responsible design of recreational channels including boatable channels. This chapter is organized as follows:

**Section 2.0 – Natural Stream Corridors.** This section highlights the many functions and benefits of natural stream corridors then describes some of the threats to these natural systems that can be imposed by urbanization. Historically, urban impacts have included realigning or straightening streams, narrowing the width of natural floodplains, and even replacing surface streams with underground conduits. Increases in runoff as a result of urbanization have contributed to degradation, aggregation, loss of vegetation and habitat, and impaired water quality. This section introduces the concept of preserving natural stream corridors and implementing techniques to restore stream functions. See the *Planning* chapter for techniques for implementing preservation.

**Section 3.0 – Preserving Natural Stream Corridors.** This section recommends several key actions that are necessary at the outset of development to preserve natural stream corridors. Preservation includes providing ample room for the floodplain, reducing increases in urban runoff, and addressing problems proactively. These actions can reduce impacts and provide for future stream management at a lower cost and smaller footprint compared to constrained floodplains where elevated discharges must be conveyed in narrow corridors.

**Section 4.0 – Stream Restoration Principles.** Eight principles of stream restoration are discussed to provide design guidance for developers, engineers, ecologists, and others involved in the protection of stream resources. The principles are valid for a variety of stream conditions, whether the corridor has been preserved as described in Section 3.0 or constrained and impacted through urbanization. Special design considerations are recommended for constrained urban stream reaches where velocities and shear stress imposed by elevated peak discharges are greater and infrastructure tends to be in close proximity to the stream.

**Section 5.0 – Naturalized Channels.** Sometimes streams need to be created where adequate channel conveyances do not exist. This section applies the principles of Section 4.0 to the design of naturalized channels. When designed with natural features, these channels can become established in a form that may be indistinguishable from natural streams.

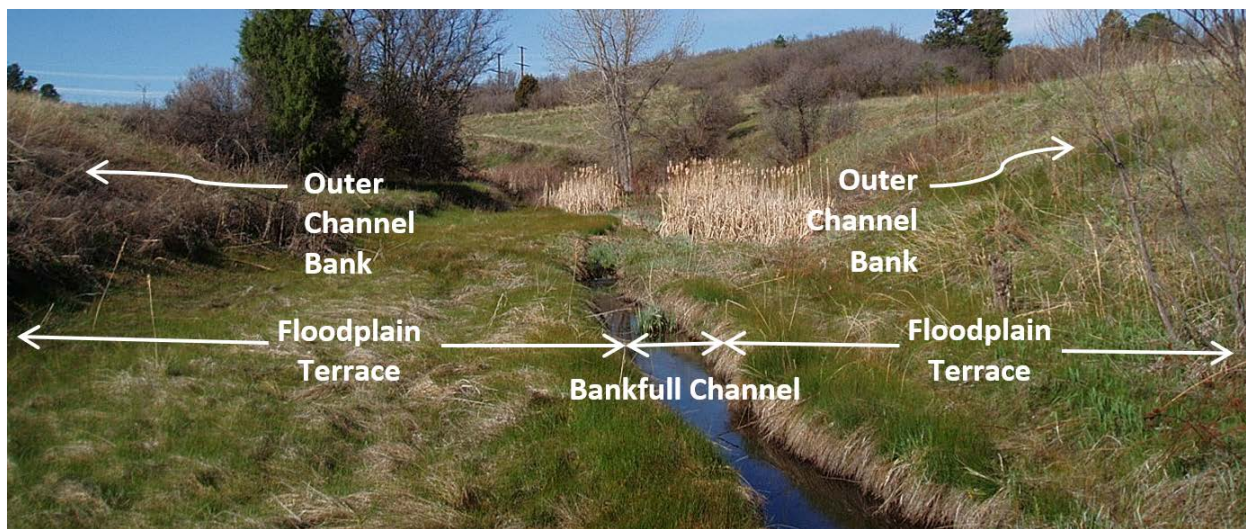
**Section 6.0 – Swales.** As an alternative to storm drains, it is often desirable to create small surface channels, or swales, to convey runoff from small drainage areas. This section provides guidance for the design of grass and rock (soil riprap or void-filled riprap) swales.

**Section 7.0 – Hydraulic Analysis.** This section provides guidance on the hydraulic analysis of natural and constructed stream systems, emphasizing the use of HEC-RAS for hydraulic modeling.

**Section 8.0 – Rock and Boulders.** The use of soil riprap, void-filled riprap, and boulders in stream restoration and constructed channels is addressed in this section.

## 2.0 Natural Stream Corridors

Natural stream corridors, as illustrated in Figure 8-1, often contain a primarily non-vegetated bankfull channel that may flow continuously or ephemerally within adjacent vegetated floodplain terraces (also called benches or overbanks) and higher outer banks. An appropriately sized single-thread channel with floodplain terraces creates favorable conditions at baseflows, producing greater depth, lower temperatures, and better aquatic habitat. The spilling of flows out of the bankfull channel onto wider floodplain terraces provides important interaction between water, soil, and vegetation. As floodwaters spread out onto the floodplain terraces, energy is dissipated, riparian vegetation receives water, and sediment can be conveyed through the system.



**Figure 8-1. Natural channel cross section illustrating floodplain terraces**

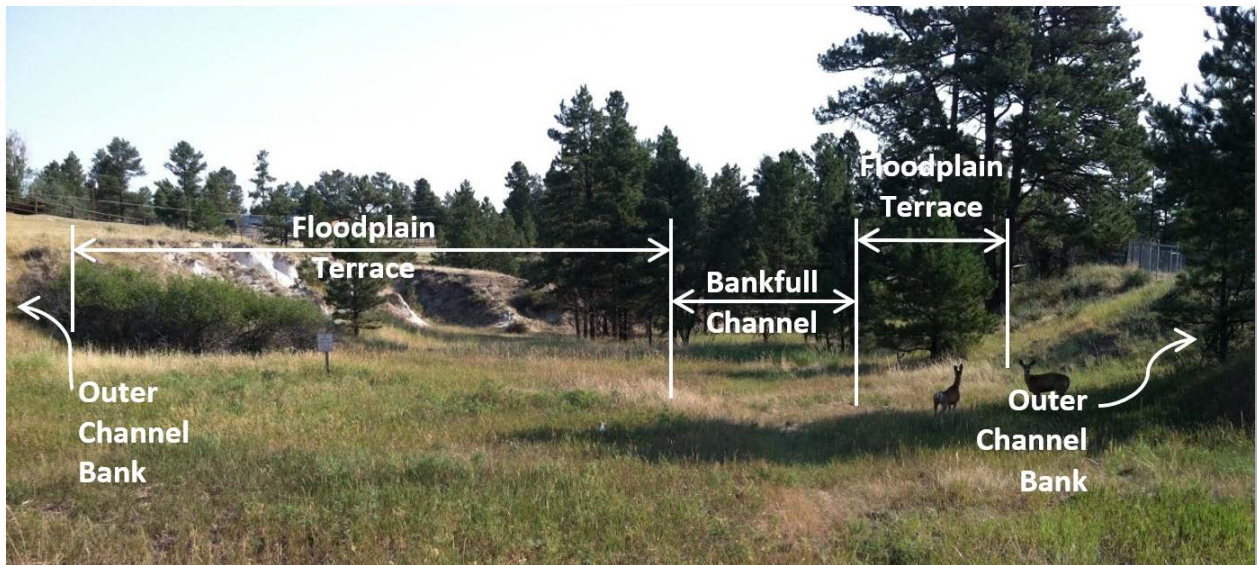
Natural channels take other forms besides the appearance of the cross section in Figure 8-1. They may be influenced by a relatively high sediment load and have a wide, sandy bankfull channel as illustrated in Figure 8-2. Or they may be vegetated across the entire channel bottom, either with wetland species if the channel is normally wet or transitional or upland species if it is normally dry. Figure 8-3 shows a dry, vegetated stream common to upland areas. These channels also function best when high flows are allowed to spread out over a wider floodplain. Natural stream channels are dynamic and change over time in response to hydrology, watershed conditions, and other factors. Large floods can result in rapid channel evolution/avulsion. When the floodplain is preserved, these natural changes have space to occur with lower potential for damage than channels that are constrained.

During high flow events, the water level rises and spreads to a width and depth associated with a specific return period. Local, State, and Federal floodplain criteria are most commonly associated with the 100-year event. In some cases, the 500-year event is mapped and human development is limited with respect to this criterion. The overall width of the stream corridor should be planned and designed to convey these large flood events that can and will occur.





**Figure 8-2. Example sand-bed stream**



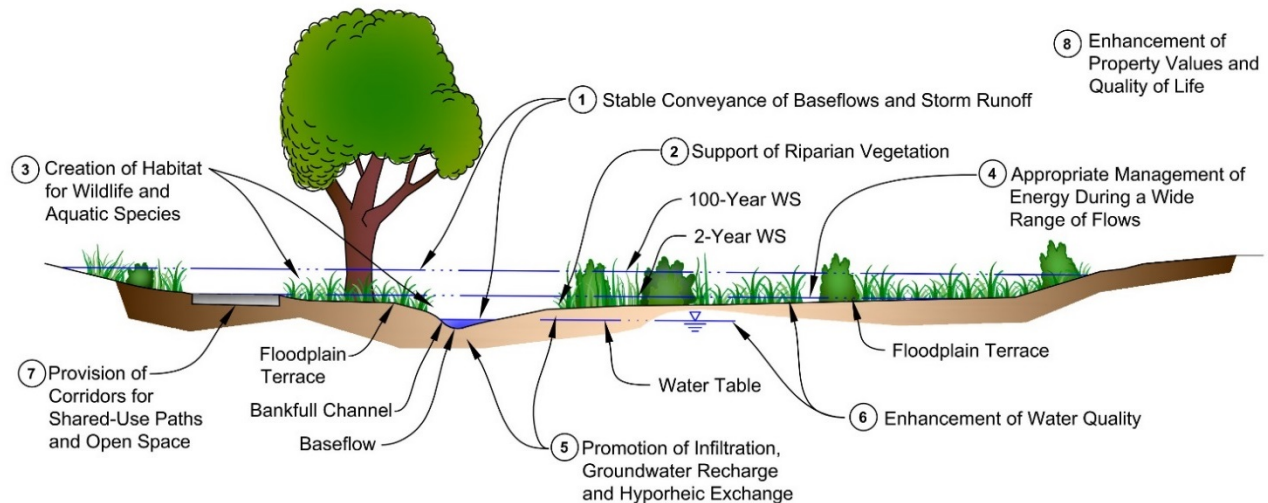
**Figure 8-3. Example upland channel**

**2.1 Functions and benefits of Natural Streams**

Healthy streams and floodplains provide a number of important functions and benefits. These are summarized below and illustrated in Figure 8-4.

1. Stable conveyance of baseflows and storm runoff.
2. Support of riparian vegetation.
3. Creation of habitat for wildlife and aquatic species.

4. Appropriate management of energy during a wide range of flows.
5. Promotion of infiltration, groundwater recharge, and exchange of surface and subsurface water in the hyporheic zone located under and adjacent to the low-flow channel (this exchange has been shown to be an important beneficial biological process).
6. Enhancement of water quality through reduced erosion and through vegetative filtering and soil-water interactions.
7. Provision of corridors for trails and open space.
8. Enhancement of property values and quality of life.



**Figure 8-4. Functions and benefits of natural stream corridors** (Source: Arapahoe County)

## 2.2 Natural Stream Corridors Prior to Urbanization

Natural stream systems are dynamic, responding to changes in flow, vegetation, geometry, and sediment supply. In the absence of urbanization, these stream systems are generally free to undergo dynamic change with little negative impact. A free, open, natural stream system is characterized by:

- Space to move and adjust,
- Capacity to convey floods,
- Natural flow regime of water and sediment,
- Channel form adapted to its flow regime, and
- Riparian vegetation established to suit the natural hydrology and soils of the corridor.

Such streams, although subject to aggradation, degradation, and other channel adjustments, are generally able to sustain themselves over the long term.



## 2.3 Urban Stream Corridors

### 2.3.1 Impacts and Constraints

In developing urban environments, the driving variables of flow, sediment movement, geometry, and vegetation can undergo significant and rapid changes, exaggerating and accelerating the kind of adjustments the stream makes; as a result, streams in urban environments face threats that can degrade the functions and benefits highlighted in Section 2.1.

In addition, urbanization often places homes, roadways, and infrastructure in close proximity to streams and their floodplains, exposing them to risk of damage from channel movement, bed and bank erosion, and inundation with runoff and mud and debris during flood events. The encroachment of development on stream corridors can limit the allowable width and depth of floodplains, increase velocities and erosive power of flood flows, and impose constraints on the type of improvements necessary to improve channel stability.

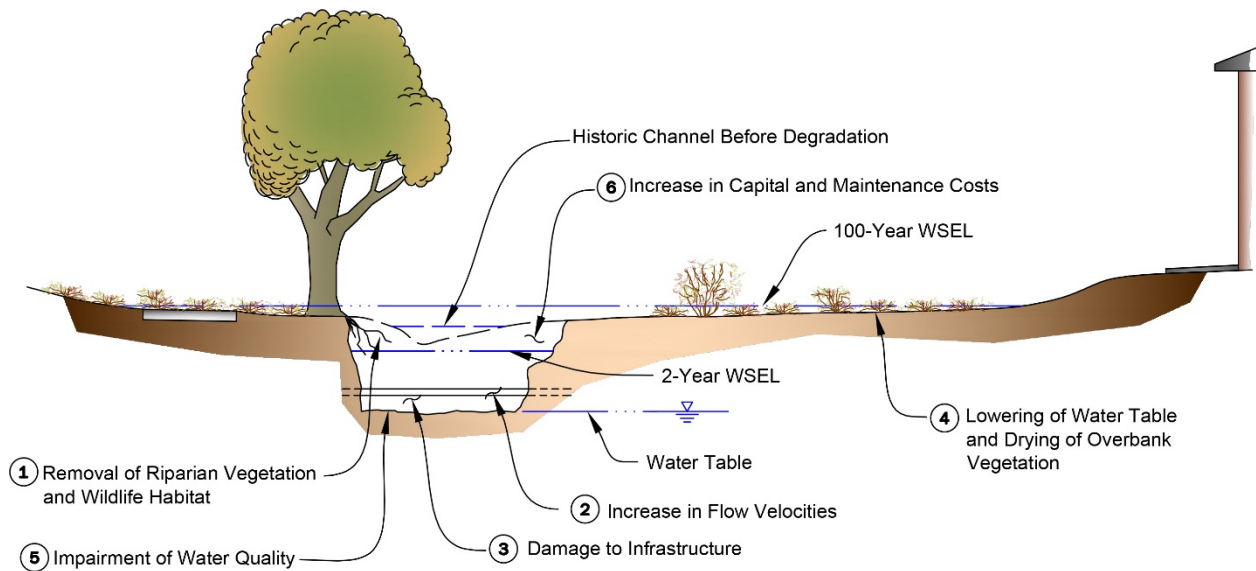
### 2.3.2 Stream Degradation

Urbanization typically increases the frequency, duration, volume, and peak flow rate of stormwater runoff. Based on a review of Colorado Front Range hydrologic analyses, average annual runoff volumes and peak discharges in urban areas can increase by an order of magnitude or more compared to predevelopment conditions. The largest increases in volume and peak discharge occur in the more frequent events that comprise the critical stream-forming flows. In addition, by re-surfacing the ground with pavement and landscaping and installing water quality and flood storage facilities, urbanization can decrease the supply of watershed sediment below pre-development conditions.



**Photograph 8-1.** Extreme degradation in an unstable channel.  
(Source: Arapahoe County)

As a result of increased runoff and reduced sediment loading, urban streams tend to degrade and incise toward a flatter slope as the channels seek a new condition of equilibrium to transport that water and sediment. An extreme example of degradation is shown in Photo 8-1. Degradation produces a number of negative impacts to riparian environments and adjacent properties. These are illustrated in Figure 8-5 and described below.



**Figure 8-5. Impacts of stream degradation** (Source: Arapahoe County)

1. **Removal of Riparian Vegetation and Wildlife Habitat.** Erosion typically strips natural vegetation from the bed and banks of streams. This disrupts habitat for aquatic and terrestrial species and leaves the stream exposed to further erosion damage.
2. **Increase in Flow Velocities.** An incised channel concentrates runoff in a narrow, deep section and increases flow velocities and shear stresses. Increased velocities continue to erode the channel.
3. **Damage to Infrastructure.** Channel erosion can threaten utility lines, bridge abutments, and other infrastructure. Utility pipelines that were originally constructed several feet below the bed of a creek can become exposed as the bed lowers. Damage to the utility lines can result as the force of water and debris come to bear against the line. Channel degradation can expose the foundations of bridge abutments and piers, leading to increased risk of undermining and scour failure during flood events. Erosion and lateral movement of channel banks can cause significant damage to properties adjacent to streams, especially if structures are located in close proximity to the banks.
4. **Lowering of Water Table and Drying of Terrace Vegetation.** In many cases, lowering of the channel thalweg and baseflow elevation leads to a corresponding lowering of the local water table and less frequent flows on the floodplain terraces. Besides the loss of water storage, lowering the water table can “dry-out” the terraces and can effect a transition from wetland and riparian species to weedy and upland species, harming the ecology of floodplain terrace areas. It should be noted that raising the degraded channel up again will raise groundwater levels closer to the surface and may impact properties adjoining the floodplain.
5. **Impairment of Water Quality.** The sediment associated with the erosion of an incised channel can lead to water quality impairment in downstream receiving waters. One mile of channel incision 5-feet deep and 15-foot wide produces almost 15,000-cubic yards of sediment that could be deposited in downstream lakes and stream reaches. Along the Front Range of Colorado, these sediments typically contain naturally occurring phosphorus, a nutrient that can lead to accelerated eutrophication of lakes and reservoirs. Also, channel incision impairs the “cleansing” function that natural floodplain terraces can provide through settling, vegetative filtering, wetland treatment processes, and infiltration.

6. **Increase in Capital and Maintenance Costs.** Typical stabilization projects to repair eroded streams require significant capital and maintenance investment; the more erosion, generally the higher the cost.

Although degraded channels may eventually erode and widen to create new floodplain terraces at a lower elevation following a process called the *channel evolution model* (CEM), this would damage infrastructure and impact water quality in the process. Channel evolution is complex, and a number of different CEMs have been developed by fluvial geomorphologists to conceptually describe how streams typical of the Colorado Front Range evolve (Watson 2002). Instead, stream restoration is encouraged. As discussed in Section 2.2, stream restoration is greatly facilitated if adequate stream corridors are maintained.

### 3.0 Preserving Natural Stream Corridors

The opportunity to preserve natural stream corridors typically comes only at the outset of planning in a watershed. Preserving natural stream corridors not only preserves valuable habitat and vegetation; it can also reduce impacts and provide for future stream management at a lower cost and smaller footprint compared to constrained floodplains where elevated discharges must be conveyed in narrow corridors.

#### 3.1 Preserve Natural Streams and Riparian Vegetation

As described in Section 2.1, existing natural stream corridors are an important resource offering flood conveyance, desirable riparian vegetation, habitat, landforms, passive recreation, and the potential for water quality filtering and infiltration. Natural stream corridors



**Photograph 8-2.** Preserving an existing stream corridor within a developing area.

should be preserved –not filled in, re-graded, re-aligned, or placed in a conduit. Photograph 8-2 shows how development boundaries have been established to preserve a natural stream corridor.

New construction along streams can produce negative short term effects such as vegetation disturbance, proliferation of weeds, susceptibility to damage during high runoff events, and nutrient leaching associated with runoff coming into contact with freshly disturbed soils. Therefore, it is desirable to preserve as much of a natural stream corridor as possible. If measures are necessary to improve the capacity or stability of a stream reach, it is recommended that these improvements be implemented as “surgically” as possible, preserving valuable land forms, vegetation, and habitat. Photograph 8-3, taken immediately after construction of stream improvements, shows an example of preserving pockets of existing riparian vegetation. Photograph 8-4, taken two years later, illustrates how the overall recovery time of a reach of stream after construction is accelerated by preserving pockets of existing vegetation.





**Photograph 8-3.** Preserved vegetation during and shortly after construction.



**Photograph 8-4.** Same channel as left, 2 years after construction.

### 3.2 Provide Ample Space for Stream and Floodplain

Streams and their floodplains require space to remain fully functional. Ample space needs to be provided both horizontally and vertically.

Horizontal space is necessary to allow the stream to naturally flex and adjust as it seeks dynamic equilibrium. An ample corridor width is necessary to enable high flows to spread out over the floodplain. As is discussed in Section 4.3, relative roughness increases and flow velocity and erosive force decreases as the wetted channel width increases for a given flood discharge. Therefore, wide floodplains are generally more stable than narrow floodplains for a given flow rate.

Ample corridor widths generally allow softer stream improvements more reliant on cross section shaping and vegetation, as indicated in Photograph 8-5. When the available horizontal space is constrained, as shown in Photograph 8-6, channel conveyance and stabilization improvements are always more challenging and costly.

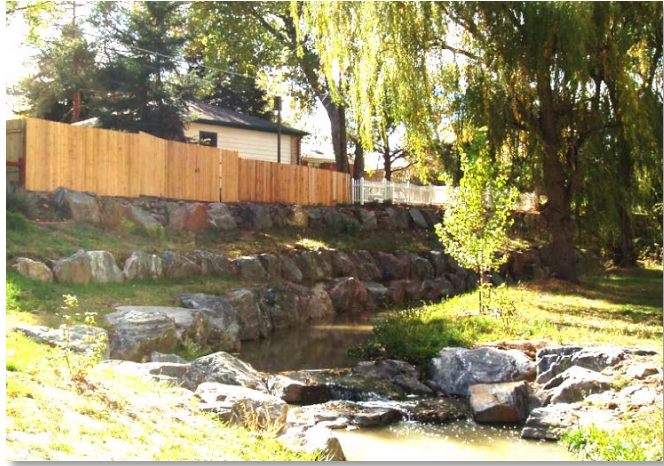
Vertical space is necessary to allow floodplain elevations to rise over time. Floodplain elevations can rise over time due to the following:

- Increased baseflows and runoff from development can promote increased growth of wetland and riparian vegetation, making streams hydraulically rougher and leading to greater flow depths.



**Photograph 8-5.** Ample space generally allows softer stream improvements more reliant on cross section shaping and vegetation.

- Stream restoration work usually has the goal of raising the bed of incised channels to levels that existed prior to degradation. This effort, plus modifying channel slopes to flatter or more stable grades, can increase water surface elevations above mapped or regulatory floodplains modeled based on the degraded condition.
- Upstream bank erosion or watershed erosion over time can lead to sediment deposition and channel aggradation in downstream channel reaches that may have wider sections, flatter slopes, or increased channel vegetation—raising streambed and floodplain elevations.



**Photograph 8-6.** Channel improvements tend to be more structural and costly when space is limited.

The most important reason for providing ample space for streams is recognizing the tremendous power of floods to convey and deposit rock, mud, and debris and carve new channel alignments irrespective of property or infrastructure. The Front Range floods of September 2013 showed that impacts are often felt beyond the limits of regulatory floodplains. As an example, Figure 8-6 indicates that the area impacted by the 2013 flood (indicated by blue shading) in this reach of Fourmile Canyon Creek in Boulder is larger than the area of the regulatory 100-year floodplain (indicated by red outline), even though the 2013 event was estimated to have a peak discharge less than the 100-year flow rate.

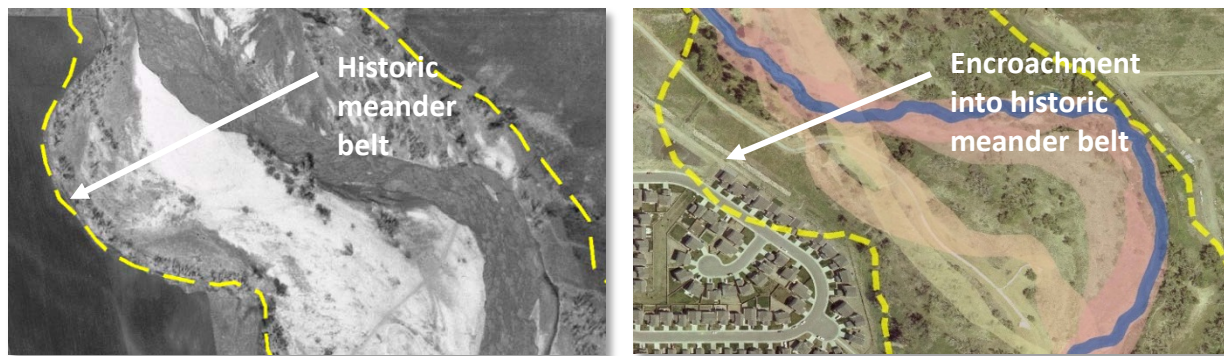
Therefore, providing ample space for streams in the following ways is strongly recommended to reduce risk to people and property.





**Figure 8-6. Fourmile Canyon Creek, September 2013 flood impacts and floodplain**

**Avoid Floodplain Filling and Encourage Stream Preservation Zones.** Building structures adjacent to floodplains carries risk; filling existing floodplains and building structures closer to flooding sources increases that risk, especially when the filling creates higher flood velocities. Some communities have adopted stream preservation zones that limit filling and new development within stream corridors that may be wider than the 100-year floodplain. This is prudent given the power and unpredictable nature of floods. Support for this policy can often be seen in aerial imagery as shown in Figure 8-7. The historic meander belt width, indicating channel movement over time, can be many times wider than regulatory floodplains.



**Figure 8-7. Importance of stream preservation zones**

**Provide Ample Freeboard.** Freeboard is the vertical distance above a referenced floodplain water surface to a specific elevation associated with constructed infrastructure, typically the lowest elevation of a building site adjacent to a floodplain, the lowest habitable floor of a structure, or the low chord of a bridge spanning a stream. It is critical to recognize that higher water surface elevations can and will occur as a result of increased channel vegetation and roughness, aggradation, raising degraded inverts, and flood debris. Urban Drainage and Flood Control District (UDFCD) recommends providing 18 inches or more of freeboard for new development projects to account for these changes, as these changes cannot be considered when determining the regulatory floodplain. Bridges often have higher freeboard requirements to account for debris. Where risk or damage associated with flooding is high, or there is high potential for sediment, rocks, and debris in runoff, the designer should elect to incorporate additional freeboard.

### 3.3 Manage Increased Urban Runoff

Stream degradation is often associated with the increased peak discharge, volume, and frequency of urban runoff, especially during small (occurring multiple times each year) to moderate (occurring once every several years) flood events. Employing runoff reduction techniques (e.g., minimizing directly connected impervious areas) as well as implementing full spectrum detention to reduce urban runoff peak flows and volumes can mitigate the impacts of urbanization. These two strategies represent Steps 1 and 2 of the Four Step Process as described in Volume 3 of the Urban Storm Drainage Criteria Manual (USDCM).

Runoff reduction can be accomplished through a variety of techniques, including the following, each of which is described in Volume 3:

- Minimizing directly connected impervious area,
- Grass buffers and swales,
- Permeable pavements,
- Bioretention/rain gardens, and
- Sand filters.

Full spectrum detention, if implemented in significant portions of a watershed, holds the potential for controlling peak discharges to levels similar to pre-development conditions over a wide range of storms from small, frequent events to large, rare events. If portions of a watershed have been developed without full spectrum detention, or without any detention at all, local governments may be able to explore opportunities to retrofit full spectrum detention facilities to reduce the impacts of elevated urban runoff.



Master plan modeling has shown that retrofitting regional full spectrum detention in a watershed can more than pay for itself in reduced stream stabilization costs (Cottonwood Creek Outfall Systems Plan, 2012 and Happy Canyon Major Drainageway Plan, 2014). Full spectrum detention is described in detail in the *Storage* Chapter of Volume 2.

It is generally good practice to locate regional detention facilities on smaller tributaries with low sediment loading rather than in streams having significant upstream watershed area and sediment load. This reduces the likelihood that the detention facilities will quickly fill with sediment from the natural stream system and release flows with reduced sediment load that may initiate a cycle of degradation in the reach downstream.

However, siting a regional detention facility on a larger stream where the sediment load is low, the upstream and downstream reaches have low erosion potential, and where regional water quality is a specific objective may be beneficial. Several of these large online regional detention facilities have been constructed on streams leading into Cherry Creek Reservoir in Denver as part of an overall plan to protect water quality in the reservoir.

### 3.4 Monitor and Proactively Address Channel Instability

The restoration process is intended to be proactive, best started prior to the onset of significant development and resulting stream erosion in the watershed. Addressing problems when they are small rather than waiting until severe degradation occurs reduces disturbance to existing vegetation and habitat resources, protects water quality, and reduces the extent and cost of stabilization improvements. The objective of a proactive stream stabilization approach is to implement improvements at the appropriate pace, in the appropriate locations, and of the appropriate type to stay ahead of problems.

A proactive approach to address channel instability requires a commitment to undertake regular surveys of stream systems, identify early signs of degradation, aggradation, earmark funding, secure easements, and undertake design and construction of improvements at a relatively early stage in the erosion process. A proactive approach generally allows a set of improvements that is relatively modest, soft, oriented toward reinforcing potential weak points, and intended to work in conjunction with the portions of the existing stream system that are generally stable on their own. This reduces the extensive disturbance, re-grading, and structural measures that are often necessary to address severe erosion after it has already taken place. Proactive measures can be financially challenging as these need to be constructed prior to development; however, the alternative of waiting until the channel degrades is more costly.



**Photograph 8-8.** Proactive stabilization at McMurdo Gulch, constructed with little disturbance to the existing channel.

## 4.0 Stream Restoration Principles

This section introduces the concept of stream restoration. In general, stream restoration is aimed at re-establishing the natural and beneficial functions of a stream corridor depicted in Figure 8-4. Although a degraded channel similar to the condition shown in Figure 8-5 and Photograph 8-7 could be left in a narrow, deep configuration and perhaps protected with heavy rock lining, stabilizing the invert in its lowered condition would potentially perpetuate a low water table, dried out terrace vegetation, high flood velocities, and reduced water quality filtering and infiltration in the terraces. It would be ideal, and often less expensive, to raise the invert to re-connect the channel with its floodplain, as shown in Photograph 8-8. It is better to promote healthy floodplain terrace conditions that can handle periodic flood flows, controlling increased runoff from development than to “force” a degraded channel into a stabilized condition using extensive structural measures.



**Photograph 8-7.** Degraded channel (before restoration).



**Photograph 8-8.** Same channel as photo 8-7 after restoration.

Eight principles for stream restoration are discussed in the following subsections. The principles are valid for a variety of stream conditions, whether the corridor has been preserved and protected as described in Section 3.0 or constrained and impacted through urbanization. Special design considerations are recommended for constrained urban stream reaches where velocities and shear stress imposed by elevated peak discharges are greater and infrastructure tends to be in close proximity to the stream. Stream restoration measures tend to be more structural and costly in constrained corridors where maintaining or increasing flood capacity is typically the highest priority.

The principles are not a “cookbook” or “one size fits all” set of design steps, but rather principles to be applied to channel reaches with the experience, judgment and collaboration of a multi-disciplinary design team. Consider the following expertise when developing the design team: surface and subsurface hydrology, hydraulics, geomorphology, plant ecology, terrestrial and aquatic biology, environmental permitting, landscape architecture, geotechnical, and water rights.

### What does *Restoration* mean?

*Stream restoration is the process of assisting the establishment of improved hydrologic, geomorphic, and ecological processes in a degraded watershed system and replacing lost, damaged, or compromised elements of the natural system (Bledsoe, 2013).*

*Restoration is the manipulation of the physical, chemical, or biological characteristics of a site with the goal of returning natural/historic functions to a former or degraded aquatic resource (Corps of Engineers, 2011).*

*Ecological restoration is the process of assisting the recovery of an ecosystem that has been degraded, damaged, or destroyed (Society of Ecological Restoration, 2004).*

*Restoration refers to actions that result in the re-establishment of ecological processes, function, and biotic/abiotic linkages, that lead to a persistent, resilient ecosystem that is integrated within its landscape (Society of Wetland Scientists, 1998)*

From the definitions above, the idea is communicated that restoration is a matter of *assisting* ecosystems that are in a *degraded* condition to re-establish *healthy processes and functions*. Although other terms, such as reclamation, rehabilitation, and stabilization, may be used to describe activities improving the structure and health of stream corridors, especially in urban or disturbed environments, the term “stream restoration” will be used in this chapter.

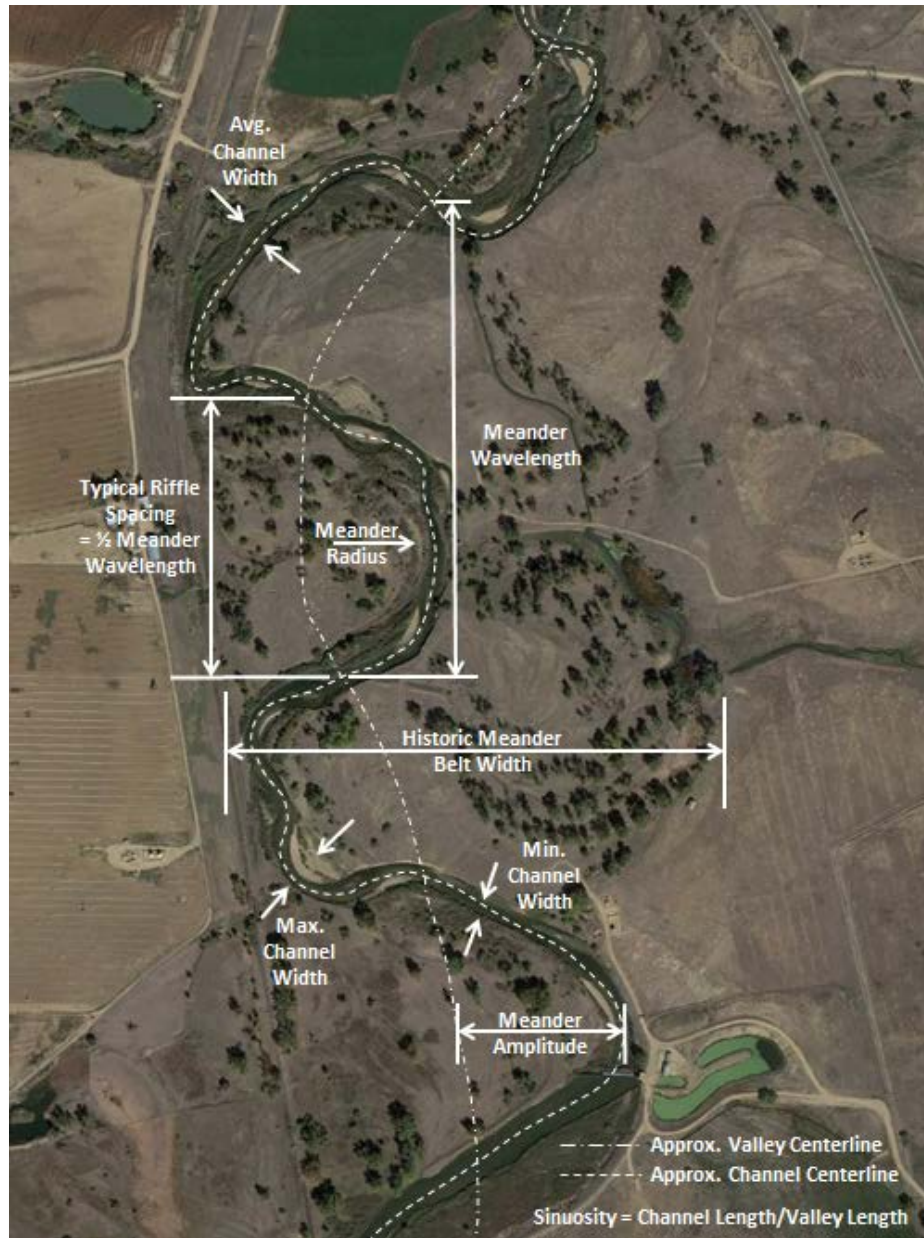
## 4.1 Understand Existing Stream and Watershed Conditions

Before any design work on a stream reach takes place, it is imperative to understand the existing conditions associated with the stream and its watershed. Review the current master plan including upstream and downstream reaches and major tributaries flowing into the reach. The master plan also provides information on existing and future development, allowing for an understanding of potential impacts due to anticipated growth. Understanding development plans and planning/zoning documents is an important component to understanding watershed conditions. Comprehensive field reconnaissance should also be performed. The following types of information should be observed on a reach by reach basis:

- Planform geometry, such as the information illustrated in Figure 8-8. Further discussion regarding channel sinuosity can be found in Section 4.4.
- Cross-section geometry, especially width and depth of the main channel below adjacent terraces, relative elevations and widths of terraces, heights and slopes of channel banks.
- Bankfull width and depth and the channel entrenchment ratio as defined in Section 4.3.
- Stream bed conditions, including bed material type and particle size, riffle characteristics, pools, steps, rock outcrops, presence of baseflows, and indications of the amount of sediment transport.
- Longitudinal slope of channel and valley along their respective centerline alignments.
- Vegetation characteristics along the channel, in floodplain terraces, at knickpoints, and channel banks.
- Signs of instability (e.g., headcuts, bed degradation/ aggradation, bank erosion, constricted channel sections) and stability (e.g., lack of erosion, favorable cross sectional geometry, dense vegetation).
- Existing facilities that modify hydrology and hydraulics such as dams, wastewater treatment plants, ponds, detention facilities, storm drain outfalls, or grade control structures.



- Horizontal distance from stream and elevation above stream of any structures or development parcels adjacent to stream as well as total unencumbered width of floodplain.
- Locations of infrastructure such as roadway crossings and utilities.



**Figure 8-8. Planform geometry of a meandering river system**

A reference reach (a stream reach with similar hydrology and watershed characteristics that displays characteristics of a stability without artificial means) can be used as a template for design of a stream restoration project. Although suitable reference reaches rarely exist for urban streams, when a reference reach can be identified in a relatively undisturbed and healthy portion of the stream or a similar stream, characteristics of a the reach can often serve as a guide for creating similar characteristics in an impaired reach.



Additional information regarding field data to collect for assessment is provided in *A View of the River* (Leopold 1994). Existing conditions should be documented with field notes, photos, and quantitative comparisons of measurable parameters.

Any available historic aerial photography should be carefully reviewed and compared to current channel conditions, noting changes that have occurred over time, and especially after large flood events. Interviews with nearby residents are another means of gathering information on the history of streams.

Available information on regulatory flow rates and floodplains and gage data should be obtained and reviewed, along with master plans and any prior stream stabilization. It is important to assess how much flows have increased from predevelopment conditions to current levels and how much further they may increase with future development—for large floods like the 100-year event and also for more frequently occurring floods such as the 2-year event. This comparison will help to quantify the increased velocities and shear stresses imposed on the stream over a range of flow rates and will help to guide the design of stabilization measures.

Assess not only the stream but also the watershed. Evaluate current aerial photography of the watershed to understand the locations and densities of existing developments. Obtain planning documents and development plans that show projected land use to estimate the extents, representative imperviousness, and anticipated timing of development projects in the watershed. The larger the development, higher the average imperviousness, and quicker the anticipated build-out, the more the potential impact on downstream channels. Review information on soils, imperviousness, hydrology, hydraulics, detention facilities, and improvement recommendations in any existing master plans conducted for the watershed.

By understanding channel behavior historically, currently, and projected into the future, the designer will have the foundation needed to develop strategies for improving the stability of the stream.

### **Stream Restoration Principle 1: Understand Existing Stream and Watershed Conditions**

#### **Representative Design Tasks and Deliverables**

1. Document results of field observations and background research on project reach, applicable reference reaches, and watershed.
2. Compile representative photos along reach.
3. Compare future development design flows for return periods ranging from 2-year to 100-year to existing and, if available, pre-development conditions to assess the relative increase in stresses imposed on the project reach.
4. Summarize findings as they apply to the design of improvements in project reach.

## 4.2 Apply Fluvial Geomorphology Principles to Manage Sediment Balance

A drainage system within a watershed involves flowing water, described by the term *fluvial*. *Geomorphology* is the study of landforms and the processes that influence the shape and dynamics of landforms. The flow of water and the associated movement of sediment that forms and shapes streams are processes that are identified as *fluvial geomorphology*. Surface form characteristics of stream channels behave in a dynamic and complex manner dependent on watershed factors such as geology, soils, ground cover, land use, topography, and hydrologic conditions. These same watershed factors contribute to the sediment eroded from the watershed and from the stream bed and banks and supplied to the channel. The sediments eroded, moved by the flowing water, and deposited in turn influence channel hydraulic characteristics.

### 4.2.1 Aggradation, Degradation, and Equilibrium

An alluvial channel is usually considered stable and in equilibrium if it has adjusted its width, depth, slope, and other factors so that the channel neither aggrades nor degrades, resulting in no significant change in channel cross section over time. This is a dynamic equilibrium in which the sediment supply from upstream is generally equal to, or in balance with, the sediment transport capacity of the channel for the full range of flows. Under watershed conditions with normal hydrologic variations affecting runoff and sediment inflow, this balance shifts and some adjustments in channel characteristics are inevitable.

An illustration, shown as Figure 8-9 (from USFISRWG 1998 [originally from Lane 195 5a]), provides a visual depiction of a stable channel balance based on the relationship proposed by (Lane 1955a) for the equilibrium concept whereby:

$$Q_w S \propto Q_s D_{50} \quad \text{Equation 8-1}$$

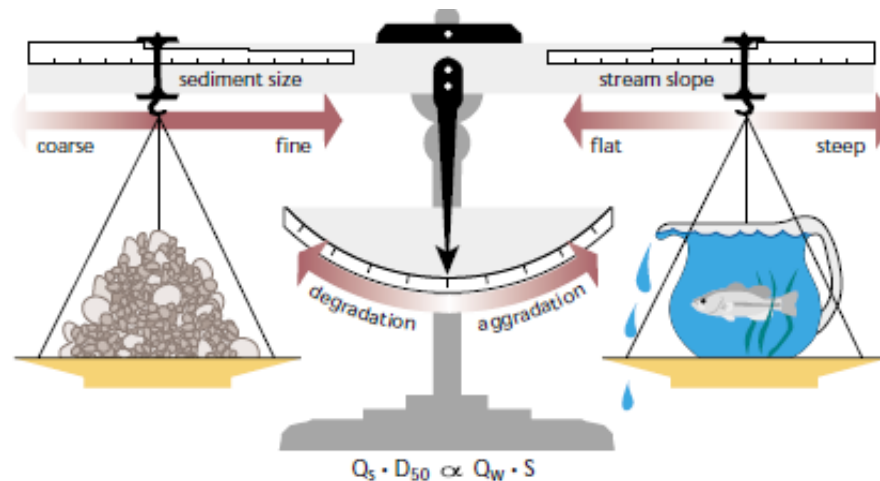
Where:

$Q_w$  = water discharge

$S$  = channel slope

$Q_s$  = bed material load

$D_{50}$  = mean particle size of bed material



**Figure 8-9. Lane's diagram**

For a stable channel, these four parameters are balanced, and, when one or more of the parameters changes, the others adjust over time to restore the state of equilibrium. For example, a typical response to increased flow associated with urbanization is an increase in bed material load through erosion of the channel and a corresponding reduction in slope. This describes channel degradation that is prevalent in urban streams. Preserving natural stream corridors and reducing urban runoff as described in Section 3.0 will reduce the magnitude and progression of stream erosion and associated deposition; however, degradation and aggradation will still occur to some extent in preserved stream corridors. Degradation and aggradation tends to be more pronounced in urban streams.



**Photograph 8-9.** Degradation in a channel.

The presence of channel degradation (erosion) or aggradation (sedimentation) is readily identified in the field. Degradation is evidenced by lowered channel inverts, high eroded channel banks, flatter longitudinal slopes, and other impacts illustrated in Figure 8-5 and Photograph 8-9. On the other hand, aggradation appears as mud, sand, or coarser sediment accumulated on the bed or floodplain terraces of a stream, burial of lower stalks of herbaceous or woody vegetation (see Photograph 8-10), steeper longitudinal slopes, and often a relatively shallow and sometimes wide sandy active channel. Aggradation and degradation processes may differ between the active channel and adjacent terraces. Sediment deposition can occur on densely vegetated terraces at the same time that degradation occurs in the active channel.



**Photograph 8-10.** Signs of aggradation include fresh, sandy deposition and the burial of plant stems.

Evidence of aggradation and degradation over time can be documented by comparing current survey information of the stream invert to any prior survey or mapping information or bed elevations that may be indicated in past floodplain or master plan profiles, considering any datum differences. For large streams, bridge maintenance records often record streambed elevations over time and original bridge design plans may indicate streambed elevations at the time the bridge was constructed. Plotting the current streambed profile against prior information is a good way of illustrating degradation and aggradation.

It is not unusual to find aggrading reaches downstream of severely degrading reaches as the high sediment load generated by the degrading reach finds a lower-energy reach and drops out. The clearer water downstream of the aggrading reach often begins another reach of degradation and the conditions can repeat in alternating cycles along the length of a stream. Although the aggrading reaches downstream of degrading reaches may appear stable, their stability may be dependent on the abnormally high erosion rates upstream; if the degrading reaches are stabilized, reaches that were formerly aggrading or in a quasi-stable condition may begin to degrade.

It is the designer’s responsibility to understand aggradational and degradational conditions along a stream and develop improvement plans that intend to appropriately manage the sediment balance.

#### 4.2.2 Dynamic Equilibrium and Threshold Principles in Stream Restoration

In its purest form, a dynamic *equilibrium* approach to stream restoration seeks to re-establish a horizontal and vertical configuration of a stream—encompassing cross section shape, longitudinal slope, sinuosity, meander pattern, bed material, and terrace vegetation that will convey inflowing sediment and sustain itself in dynamic equilibrium over a range of flow conditions without the use of hard structures. This is not to say that there will not be degradation and/or aggradation from event to event; however, over the long-term the degradation and aggradation are balanced. Equilibrium approaches have been successfully implemented by experienced practitioners to restore the health of natural stream systems, especially in montane and non-urban environments. The dynamic equilibrium approach can be very challenging in a continuously-urbanizing watershed with non-cohesive soils.

A *threshold* approach, in contrast, relies on rock or hard structures for grade control or bank protection that are sized to remain in place for a given range of design flow rates. As long as the design hydraulic threshold is not exceeded, the structures are designed to remain in place. Threshold techniques can be applied to the vegetative cover in floodplain terrace areas as long as shear stresses imposed by the design flow do not exceed the resistive stress strength of the vegetation and soil. Threshold approaches have also been successfully implemented to restore impaired stream systems, especially in the urban environment.

Pure equilibrium approaches are most feasible when the following factors exist:

1. Open, unconstrained stream corridors (to allow dynamic adjustments and enable flows to spread over floodplain to dissipate energy), with gentle valley slopes.
2. Natural hydrology relatively unaffected by urban impacts (to reduce imbalances caused by flow regime).
3. Significant sediment supply (the “building material” necessary to form the stream).
4. Relatively consistent, predictable sediment supply for given flow range (to sustain the stream form over time).
5. Cobble or gravel-bed streams (compared to sand-bed streams, are better able to resist erosion, maintain steeper slopes, promote armoring, and help form natural riffles to assist with grade control).

Factors 1 and 2 are characteristic of protected natural stream corridors as described in Section 3.0; therefore, equilibrium approaches are most feasible in protected corridors that also demonstrate one or more of the other three factors. The more a

#### **Stream Restoration Principle 2: Apply Fluvial Geomorphology Principles to Manage Sediment Balance**

##### **Representative Design Tasks and Deliverables**

1. Plot current streambed profile of project reach and upstream and downstream reaches against available information showing prior streambed elevations to estimate relative aggradation and degradation.
2. Document geomorphic assessment of stream addressing sediment supply, evidence of degradation and aggradation, predictions of future trends, and any quantitative analyses of sediment supply and equilibrium.
3. Indicate how findings of geomorphic assessment are to be applied to the design of stream restoration improvements in the project reach.



stream is constrained and impacted by urbanization, the more challenging it is to implement a pure equilibrium approach to stream restoration. As mentioned, successful implementation of a pure equilibrium approach requires a high level of understanding and experience in fluvial geomorphology principles.

A number of references have been published on the subject (Rosgen, 1996, USACE (Copeland et al), 2001, USACE (Soar and Thorne) 2001). Threshold approaches have been more often used for stream restoration in urban environments. Threshold approaches are somewhat more predictable and can be used when conditions favorable to equilibrium approaches (identified above) do not exist. Threshold approaches can be designed in several ways. In its most extensive form, it can consist of lining the entire stream width and length with rock sized to not move in the design event. More often, the threshold structures are comprised of vegetated bank protection and regularly spaced grade control structures constructed of sculpted concrete, grouted or loose boulders, and/or riprap.

In effect, most stream restoration projects in the urban environment use a hybrid approach. Threshold principles are employed for grade control structures and equilibrium principles can be used in the soft stream reaches between drop structures.

### 4.2.3 Support the Stream's Natural Capacity to Sustain Itself

If the fluvial geomorphology principles discussed above are understood, the restoration process itself can be oriented toward creating a healthy channel configuration and thus assisting the stream system in sustaining its functions primarily on its own.

Natural stream systems can act like living entities, responding and adapting to try to maintain balance. The flow of water and sediment, the establishment of riparian vegetation, and the biologic processes in streams and floodplains all have the potential to sustain themselves within a dynamic envelope over a long period of time. In a word, streams systems have a capacity for *resilience*.

The key is to protect streams from major impacts, such as severe channel incision with potential to degrade the system to a point that it cannot recover on its own, and to allow the stream enough space for some degree of natural response. The floods of September 2013 provided multiple examples where streams that had been straightened or narrowed either found their historic alignment or created a new alignment all together. Floods usually serve to remind us that streams are difficult to control if their space requirements are not understood.

The restoration approach is successful if the passage of time results in the stream system getting stronger and healthier through the working of natural stream processes, rather than weakening and degrading over time. The goal is not to “build” natural habitat and fully completed streams, but to assist in creating the conditions where the system can strengthen and maintain itself.

#### Sustainability

The goal is not to “build” natural habitat and fully completed streams, but to assist in creating the conditions where the system can strengthen and maintain itself.

### 4.3 Establish Effective Cross-Sectional Shape

One of the most fundamental principles in stream restoration is establishing an effective cross-sectional shape. This section describes the importance of a favorable cross-section shape to maintaining the function of a floodplain, discusses “bankfull” channel sizing, and illustrates how cross-section shape influences flow velocities and shear stresses.

#### 4.3.1 Maintaining Floodplain Function

A primary design task is to preserve or establish a floodplain cross section that maintains the natural function of a floodplain—a section with a bankfull channel that is appropriately sized to allow flood flows to spread out over vegetated floodplain terraces for stable conveyance, vegetative filtering, infiltration, and energy dissipation. The bankfull channel should be shallow enough to maintain a connection to the floodplain. In some reaches, deeper areas for aquatic life should also be considered. Severely degraded, incised channels do not allow that connection.

Figure 8-10 illustrates the influence of cross-sectional shape. The figure consists of three cross sections carrying the same flow rate with varying flow characteristics. The first section represents a degraded, incised channel whose flow area fills the incised channel just below the point where it would spill into the adjacent floodplain. The second section is the same as the first except that the active channel was filled to hydraulically reconnect the floodplain. It has a depth of 1.5 feet below the floodplain terraces. The third section has the same size active channel as the second, but a wider and shallower floodplain terrace.

The sections show a color-coded velocity distribution of each section. Average flow velocity in the active channel and terraces in feet per second are indicated, showing how velocity decreases as the section gets wider and shallower. Therefore, unless excessive sedimentation is expected, establishing stream configurations with relatively shallow bankfull channels and wide floodplain terraces are encouraged, since they are inherently less erosive than deeper, narrower sections. The size of the bankfull section is the most critical aspect of the cross-section in maintaining floodplain function and should be sized appropriately considering all geomorphic principles provided in this chapter.

#### Connecting the Floodplain

The bankfull channel should be shallow enough to maintain a connection to the floodplain and provide occasional flooding of the riparian vegetation.

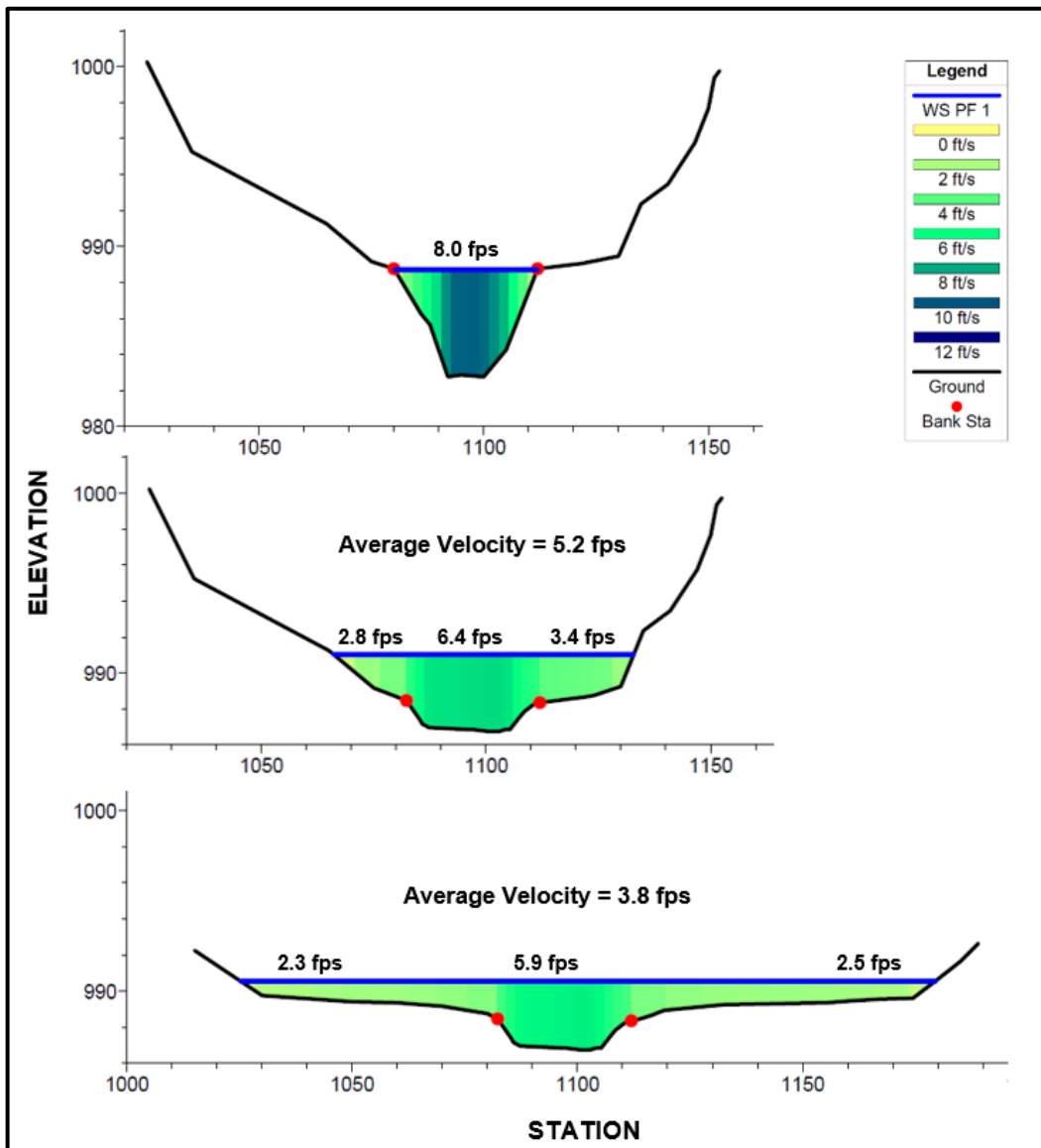
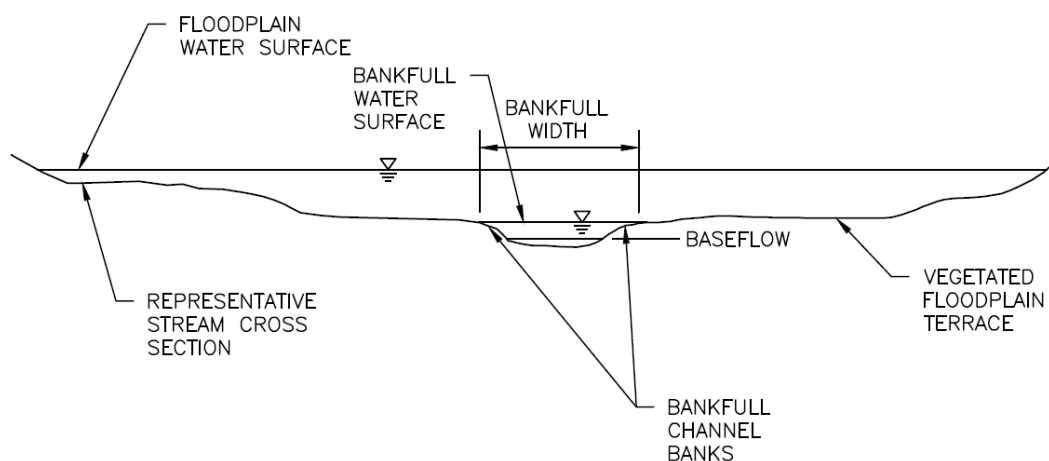


Figure 8-10. Impact of channel geometry on velocity

### 4.3.2 Sizing of Bankfull Channel

Bankfull channels were introduced in Section 2.0 and indicated in Figures 8-1 through 8-4. Based on geomorphic principles, appropriate sizing of the bankfull channel can be related to a particular discharge, termed “bankfull discharge.” Bankfull discharge is defined as the discharge where flow is just about to spill out into its floodplain terraces. Bankfull discharge is further illustrated in Figure 8-11. This section provides several approaches to approximate the appropriate bankfull discharge and in turn, determine the appropriate sizing for the bankfull channel.



**Figure 8-11. Channel cross section with bankfull discharge illustration**

**Based on reference reach.** If stable, the width and depth of the bankfull channel of a reference reach is a good starting place to estimate bankfull channel dimensions in the design reach, assuming the reference reach has not already been altered by past channelization projects. The associated bankfull discharge may be estimated based on bankfull capacity of stable alluvial reference reaches upstream or downstream of the design reach. The process involves observing the depth at which flows just spread out into adjacent floodplain terraces and then estimating the capacity of the bankfull channel at that depth based on the actual slope, roughness, and cross sectional area.

**Based on return period.** Bankfull channels are not formed based on a single return period event, however; bankfull discharge in stable natural channels has sometimes been observed to be between the 1.5- to 2-year event (Leopold 1994). In urban settings where other methods for sizing the bankfull channel may not be practical, UDFCD recommends using a bankfull discharge value equal to the developed 1.5 to 2-year flow when sizing the bankfull channel. Determination of the 1.5 to 2-year flow should be based on gage records, when available, although the resulting flow estimates will represent the development conditions existing during the period of record and may need to be adjusted upward to account for higher projections of future imperviousness. If the 1.5 to 2-year flow is based on the results of a hydrologic model, caution should be applied since variables such as floodplain infiltration can reduce observed stream flows and result in overly inflated modeled flows for frequent events, especially in large watersheds.

**Based on effective discharge.** Effective discharge is defined as the discharge that transports the largest percentage of the sediment load over a period of many years. It is used synonymously with “channel-forming” or “dominant” discharge, a theoretical discharge that, if maintained indefinitely, would produce the same channel

### References for Determining Bankfull Discharge

The following link directs readers to a video providing guidance for field identification of bankfull stage in the western U.S.:

[http://www.stream.fs.fed.us/publications/bankfull\\_west.html](http://www.stream.fs.fed.us/publications/bankfull_west.html)

Chapter 5 of *Applied River Morphology* (Rosgen, 1996) describes bankfull discharge, stage, and field determination of bankfull conditions.

Leopold, 1994 also provides guidance on determining bankfull depth in the field.



geometry as the natural long-term hydrograph. Quantitative analyses to determine effective discharge are fairly complex and depend on good data and proper application of assumptions and methods. Effective discharge analyses are documented in *Hydraulic Design of Stream Restoration Projects* (USACE 2001) and other geomorphology references. Using the effective discharge to size the bankfull channel implies an assumption that an appropriately sized bankfull channel could be based on the effective discharge, (i.e., the bankfull discharge and effective discharge are assumed to be equal).

Regardless of how the bankfull discharge is estimated, geomorphic relationships make it possible to use this value to help determine appropriate sizing of the bankfull channel width and depth. The width for natural alluvial streams has been related to bankfull discharge according to the following equation (Leopold 1994):

$$w = aQ^{0.5} \quad \text{Equation 8-2}$$

Where:

- $w$  = bankfull width of channel (top width when conveying bankfull discharge)
- $Q$  = bankfull discharge
- $a = 2.7$  (wide bankfull channel)
- 2.1 (average bankfull channel width)
- 1.5 (narrow bankfull channel)

Although this relationship applies to natural alluvial stream systems, it may serve as an approximation for streams in an urban environment, especially if corroborated with reference reach dimensions in streams not already altered by past channelization projects.

In addition, the width/depth ratio, defined below, is a useful parameter that can be key to understanding the distribution of energy within the channel and the ability of the channel to move sediment (Rosgen 1996).

$$\frac{\text{Width}}{\text{Depth}} = \frac{W}{D} = \frac{\text{bankfull channel width}}{\text{mean depth of the bankfull channel}} \quad \text{Equation 8-3}$$

Based on the relationship between bankfull width and bankfull discharge described by Equation 8-2, it is possible to estimate bankfull width based on bankfull discharge and then select a bankfull channel depth based on the area of conveyance needed to contain the bankfull discharge.

This exercise translates into width to depth ratios generally in the range of 6 to 16. Typical bankfull channel depths range from about one to three feet, where the later would be typical for bankfull channels that are a minimum of 18 feet wide. This typical width to depth ratio range of 6 to 16 appears to be generally representative of healthy streams within the UDFCD area. Streams in semi-arid areas tend to have a high width to depth ratio.

### 4.3.3 Addressing Incised Channels

Degraded streams that are too deep may require filling of incised channels, excavating floodplain terraces adjacent to the bankfull channel, or some combination of the two. Usually, filling a degraded channel is the option that results in the least disturbance to existing floodplain vegetation.

It is sometimes difficult to raise the invert of a degraded channel due to costs associated with importing fill material (if it cannot be generated onsite) or existing infrastructure such as storm sewer outfalls located near the bottom of the incised channel. It may be necessary to remove the downstream end of low storm sewer outfalls and reconstruct them at a higher elevation. Raising the invert will also cause a rise in

a critical floodplain elevation if the regulatory floodplain was based on the degraded channel condition (as discussed in Section 3.2, it is recommended that floodplains be determined for restored, not degraded channel conditions). There may be a need for compensatory excavation in another portion of the floodplain to offset any rise in the floodplain caused by filling in the eroded active channel.

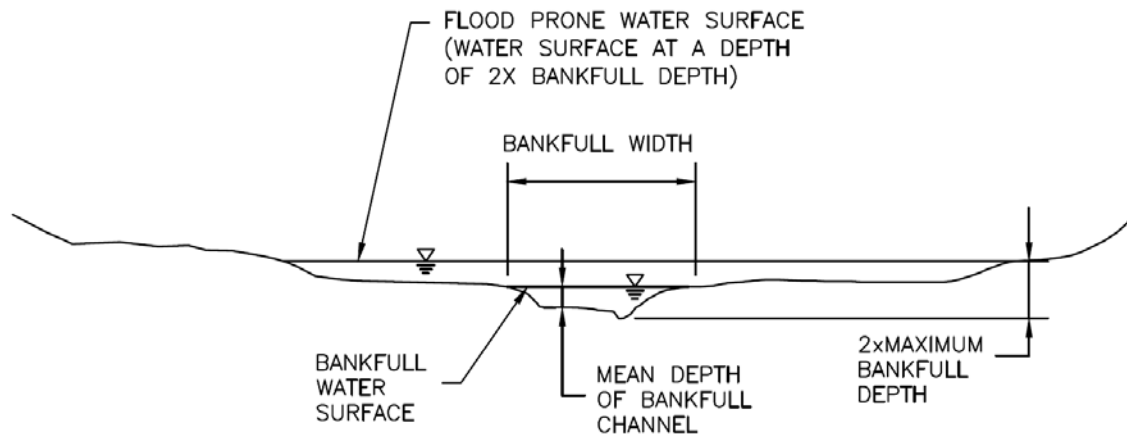
#### 4.3.4 Floodplain Terraces

As discussed above, the existence of floodplain terraces immediately above and adjacent to the bankfull channel help to spread and dissipate the energy associated with high flows. Floodplain terraces may exist on one or both sides of the bankfull channel.

It is desirable that floodplain terraces adjacent to the bankfull channel be relatively wide, flat, well-vegetated, and not excessively steep with respect to longitudinal slope. Terraces with these characteristics assist with reducing flow velocities and provide adequate capacity for larger storm events. Generally speaking, the wider the floodplain terraces, the lower the flow depths for a given return period event, the greater the relative roughness, and the lower the velocities of flow, as shown in Figure 8-10.

A useful parameter for quantifying the width of the floodplain terraces in streams not already altered by past channelization projects is entrenchment ratio, which should be similar to those of stable upstream or downstream reference reaches, ideally in the range of about three or greater. The entrenchment ratio, defined below, provides a measure related to the distribution of shear stress and the potential for erosion within the channel section (Rosgen 1996):

$$\text{Entrenchment Ratio} = \frac{\text{flood prone channel width}}{\text{bankfull channel width}} \quad \text{Equation 8-4}$$

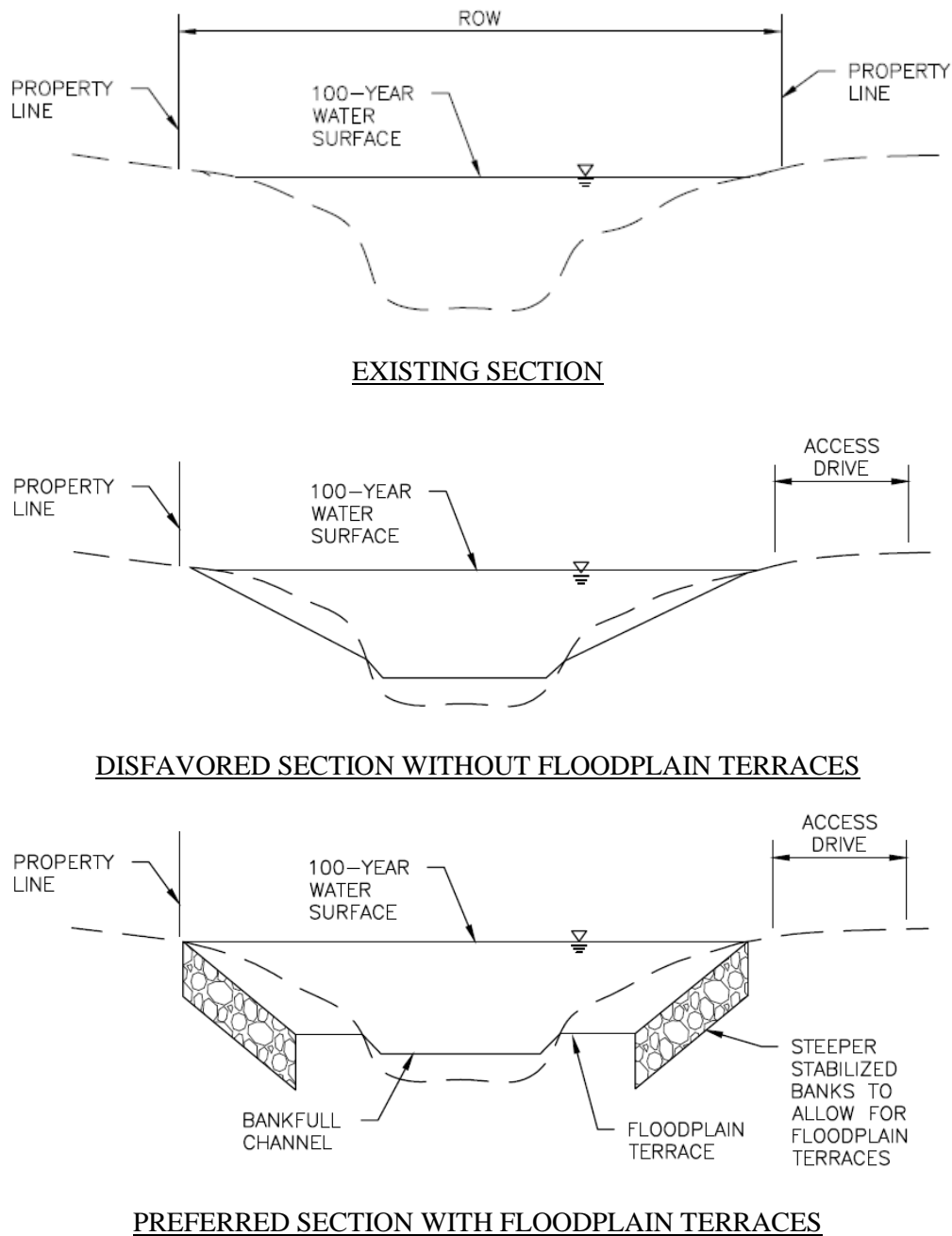


**Figure 8-12. Channel cross section with bankfull and flood prone water surfaces (Rosgen 1996)**

Channels in a degrading condition may not have true floodplain terraces evident; the former floodplain terraces may take the form of abandoned terraces situated well above the active channel invert such that they no longer receive spills when flows just exceed the actual bankfull discharge. Stream restoration efforts should seek to reestablish a connection to the channel's prior functioning floodplain terraces, or undertake grading measures, if feasible, to create new floodplain terraces adjacent to an appropriately sized bankfull channel. Desirable entrenchment ratios would be similar to those of stable upstream or downstream reference reaches, ideally in the range of about three or greater.

Some stream restoration projects are undertaken in constrained urban channels where natural floodplains have been filled and corridor widths are unnaturally narrow. In these cases, it would still be advantageous

to create a bankfull channel with an appropriate width and depth (and width/depth ratio) flanked by adjacent floodplain terraces with a reasonable entrenchment ratio. If a narrow corridor compromises channel shape, it may be better to steepen the outside banks than to reduce or eliminate a stream's floodplain terrace. This is depicted by the proposed improvements illustrated in Figure 8-13; when opening up the existing narrow channel in the limited right-of-way shown in *Existing Section*, it may be preferable to create a shape similar to that in *Proposed Section with Floodplain Terraces* rather than that in *Proposed Section without Floodplain Terrace*.



**Figure 8-13. Creating floodplain terrace in narrow corridor**

Sometimes, constrictions in stream corridors lead to locally high velocities. The constrictions may be part of the natural landform or resulting from floodplain filling taking place in the past. Opportunities to pull back banks and open up constricted areas by excavating, reshaping, and revegetating should be pursued. Hydraulics should be checked as described in Section 8.0.

The cross section geometry for all streams should allow for maintenance access. See the *Stream Access and Recreational Channels* chapter for these criteria.

### **Stream Restoration Principle 3: Establish Effective Cross-Sectional Shape**

#### **Representative Design Tasks and Deliverables**

1. Document approaches used to size width, depth, shape, and capacity of bankfull channel.
2. Summarize range of proposed entrenchment ratios in project reach and identify steps to be taken to create or maintain floodplain terraces.
3. Confirm that no filling is to take place in floodplain (however, if fill is proposed, document proposed grading limits and hydraulic impacts per Section 4.8).
4. Document minimum freeboard provided to adjacent property elevations.
5. Provide design drawings showing proposed layout of appropriately sized bankfull channel and floodplain terraces in profile and cross section.

#### **4.4 Maintain Natural Planform Geometry**

Natural streams offer variety and complexity in form; they are seldom straight and uniform. Outer banks move in and out and bank heights, slopes, and widths vary. Bankfull channels exhibit a degree of meandering and sinuosity, moving right and left across a section in an alternating manner. The shape of the bankfull channel varies as well, tending to widen slightly in bends; side slopes tend to steepen at the outside of bends and flatten as point bars form on the inside of bends. Increasing sinuosity decreases longitudinal slope. Pools can form in the channel bottom at the apex of bends.

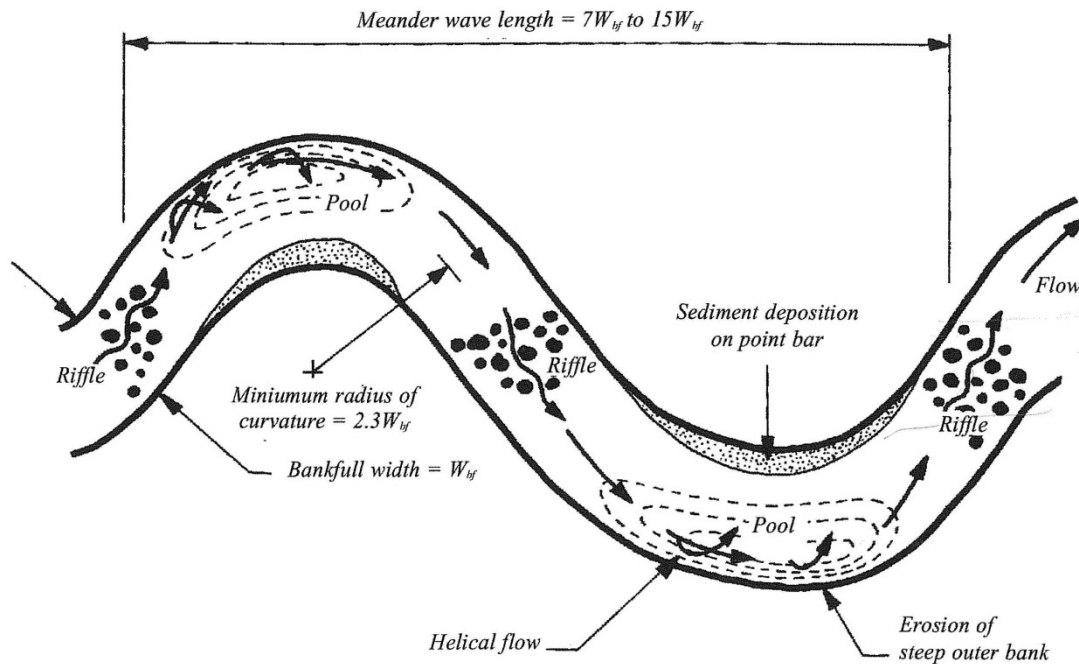
Based on typical geometry associated with sand bed streams, meander wavelength (as illustrated in Figure 8-8) may be on the order of 10 to 14 times the bankfull width of the bankfull channel (Leopold 1994). Sinuosity of a channel is defined by the following equation:

$$\text{Sinuosity} = \frac{\text{bankfull channel length}}{\text{valley length}} \quad \text{Equation 8-5}$$

Where the bankfull channel length is measured along the actual channel length and the valley length is measured along the valley.

Refer to Figure 8-8 for graphical representation of the above variables. Sinuosity is often in the range of 1.1 to 1.3 for Front Range streams.

As shown in Figure 8-14, meandering stream forms, especially if there is a presence of gravels or cobbles in the stream bed, may take on a riffle-pool form. In this case, riffles are typically located at the cross-over points between meander bends and pools occur at the outside of the meander bends.



**Figure 8-14. Riffle-pool stream form**

(Source: Newbury & Gaboury 1993)

If the historic alignment of a natural channel has been altered or disturbed, historic aerial photography may provide useful guides for restoration of the planform geometry. For streams not already altered by past channelization projects and watershed alterations, observations of reference reaches in healthy upstream or downstream reaches or similar stream systems may provide guidance for parameters such as meander amplitude and meander radius.

Figure 8-15 illustrates the planimetric alignment of a reach of Cottonwood Creek upstream of Cherry Creek Reservoir that was reclaimed with a relatively high degree of meandering (with a sinuosity of 1.9) within broad floodplain terraces and an unconstrained right-of-way.

#### **Stream Restoration Principle 4: Maintain Natural Planform Geometry**

##### **Representative Design Tasks and Deliverables**

1. Document background observations on sinuosity, floodplain width, and meander patterns in study reach or reference reaches and describe basis of proposed stream alignment and planform geometry.
2. Provide design drawings showing plan view of proposed stream restoration improvements.



**Figure 8-15. Example of meandering single-thread channel form** (Courtesy: Wenk and Associates)

#### 4.5 Develop Grade Control Strategy to Manage Longitudinal Slope

As discussed in Section 2.3, a typical stream response to increased urban runoff is to trend toward flatter longitudinal slopes, which, if left unmanaged, leads to degradation and channel incision. A primary management approach to limit degradation is the installation of grade control structures along the length of a stream; the structures hold grade so if the stream wants to flatten its equilibrium slope, incision is limited.

Grade control structures do not create the equilibrium slope of a stream; the stream does. Even a channel filled or constructed at a specific slope will cut or fill within a range of its equilibrium slope. Sometimes a period of high sediment load, which could occur during a large runoff event or result from upstream erosion, will lead to a temporary steepening of the slope, which may reduce during prolonged periods of lower sediment load.

The placement of grade control structures is related to three primary considerations, equilibrium slope, cross sectional capacity, and drop structure height:

**Equilibrium slope.** Equilibrium slope influences the cumulative drop height needed for a specific stream reach. The estimated equilibrium slope is the flattest slope anticipated in a stream reach over the long term. The actual slope of a stream may vary over time. It is possible that an open channel may exhibit a steeper slope than the estimated equilibrium slope for periods of time, especially if a stream is subject to a high sediment load. At other times slopes may flatten in response to lower sediment loads. Plan to construct check structures with the assumption that these buried structures will eventually become drop structures and, based on the minimum estimated equilibrium slope, will not be undermined. If the channel maintains a steeper slope, or temporarily steepens in response to high sediment loading conditions, this may lead to a partial burying of grade control structures, but without negative effect. The term “grade control structure” generally refers to structures intended to reduce the channel slope and control the elevation of the channel invert (i.e., check structures and drop structures). See the *Hydraulic Structures* chapter for more information.

If the long-term equilibrium slope of the bankfull channel is less than the longitudinal slope of the adjacent terraces, grade control structures are required with the intent of achieving the appropriate slope

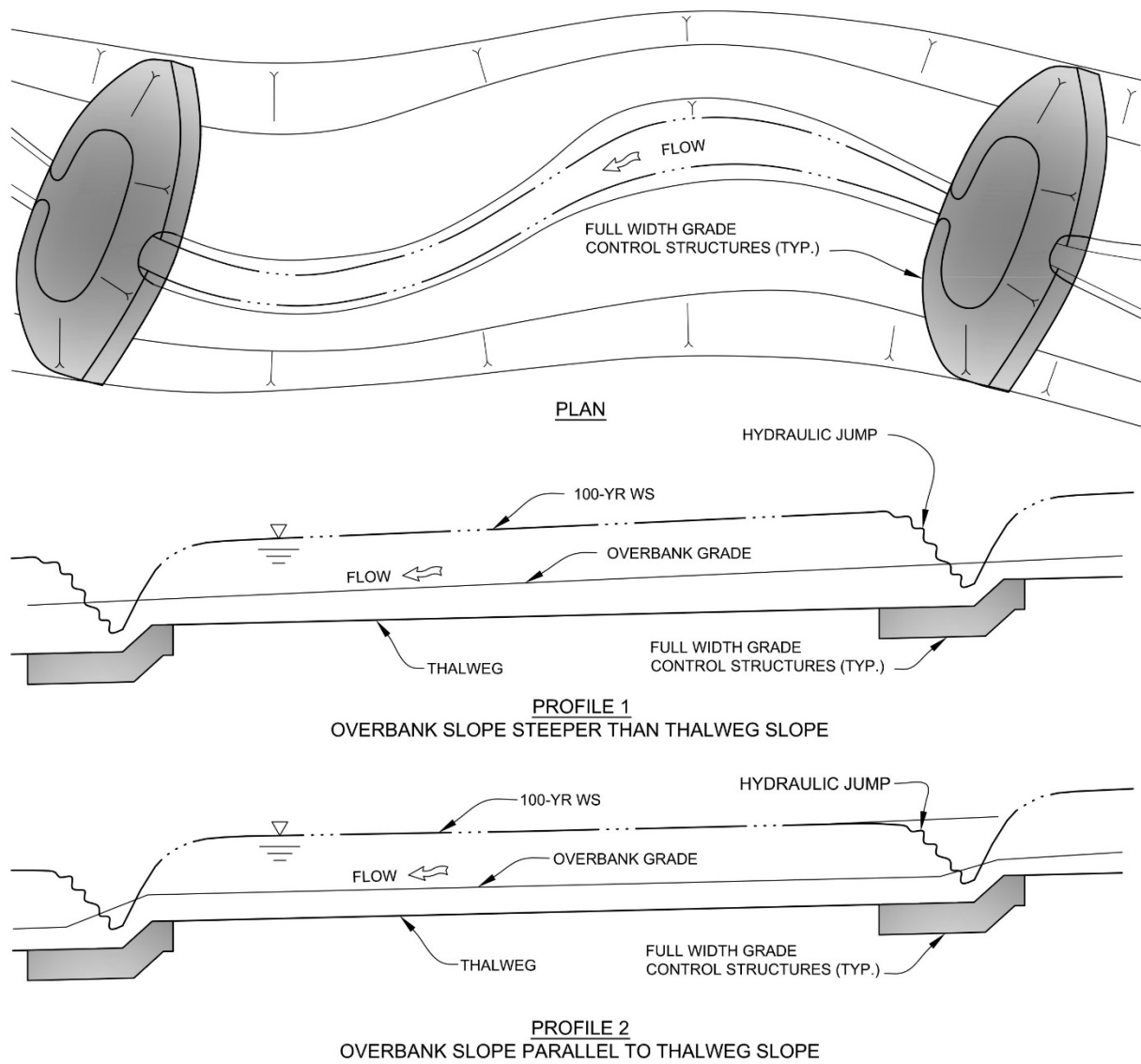
between the structures. The location of grade control structures can be determined by extending the estimated equilibrium slope from the crest elevation of a downstream grade control structure to the downstream invert of the next grade control structure upstream. Several approaches are available to estimate long-term equilibrium slope:

1. In streams not already altered by past channelization projects, equilibrium slope can be estimated using a reference reach approach. This is a qualitative fluvial geomorphology method that correlates equilibrium slopes from similar streams that have undergone changes (aggradation or degradation) in slope in response to urban development. Reference reaches have similar geomorphic characteristics as the project reach such as watershed size, watershed imperviousness, soil type, bed material, sediment loading, etc. In addition, the reference reach must be in equilibrium conditions and not unduly influenced by unstable upstream conditions (i.e., high sediment loads from eroding upstream channels or tributaries). Reference reach evaluations require familiarity and experience in geomorphology and river mechanics.
2. Sediment equilibrium analyses can be undertaken to estimate a longitudinal gradient that will provide for a balance between the expected inflow of water and sediment to a reach and the ability of the reach to convey that water and sediment without significant long-term aggradation or degradation. Like the reference reach approach, sediment equilibrium analyses require familiarity and experience in geomorphology and river mechanics.
3. Equilibrium slope may have been estimated in an UDFCD master plan.
4. A conservative low estimate of equilibrium slope for many urban stream systems within UDFCD boundaries is between zero and 0.2 percent. Sandy channel reaches subject to perennial flows in watersheds with significant urbanization and very low sediment load have been observed in the field at a near zero percent slope. Grade control structures laid out based on a zero or near-zero percent slope may at times of higher flow, higher sediment loading, and slightly steeper slope have their vertical drop height reduced on a temporary basis, but generally without negative effect as long as the sediment load and level of aggradation is not excessive.

Once a minimum equilibrium slope has been estimated, the overall drop structure height for a reach is the product of the reach length and the difference between the equilibrium slope and the actual slope or the floodplain terrace slope.

Cross sectional capacity. Drop structures are designed to span across the bankfull channel and some portion of the floodplain and are intended to tie into both floodplain terraces of the channel. In some streams, the grade control structures are designed to extend across the full width of the channel from outside bank to outside bank; these drop structures fully convey the capacity of the channel, which could include the 100-year event. This is depicted in Figure 8-16.



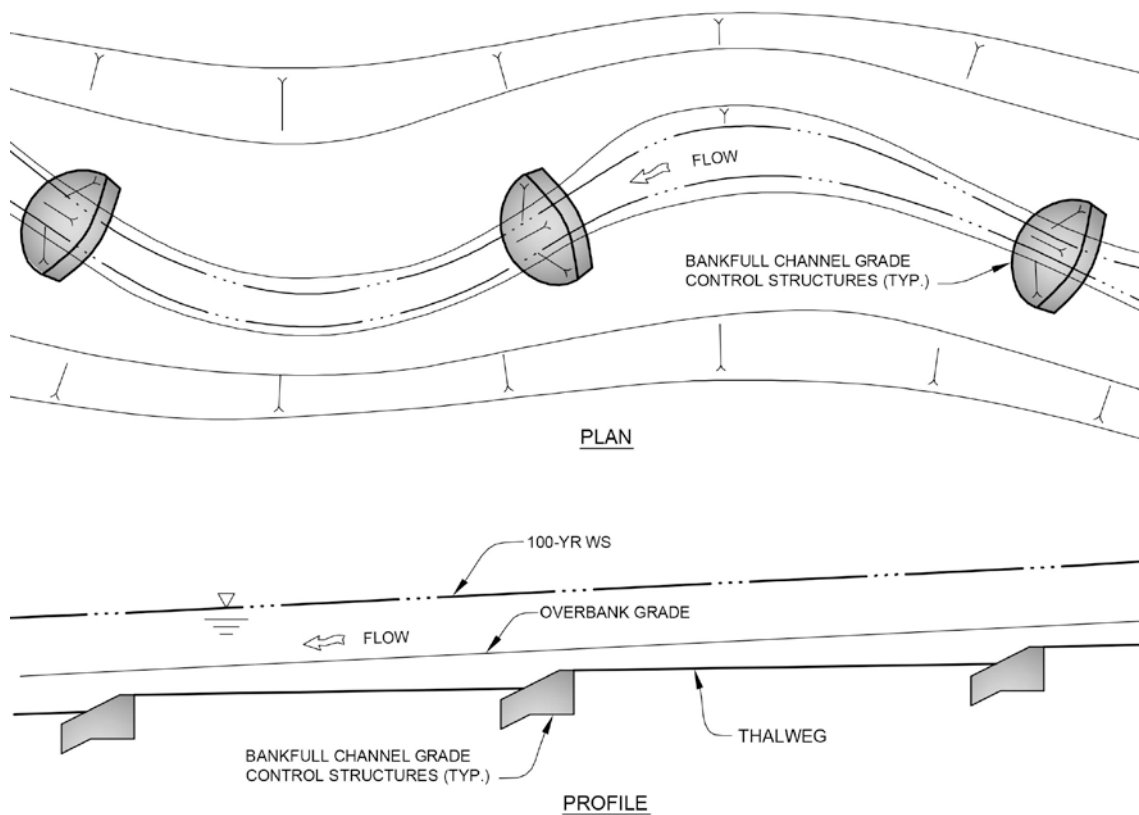


**Figure 8-16. Full width grade control structures**

Two longitudinal profiles are shown in Figure 8-16. The first assumes that the bankfull channel invert develops a long-term equilibrium slope that is flatter than the adjacent floodplain terraces; in this case the depth of the bankfull channel varies and is typically at a minimum just upstream of a grade control structure and a maximum just below the next drop structure upstream.

The second profile shows the slope of the floodplain terraces parallel to the invert of the bankfull channel. This case could occur when there is a natural drop in grade across the whole width of the channel, or when a design includes re-grading the terraces and a constant bankfull channel depth is maintained. In each profile, hydraulic jumps are shown to occur at the full-width grade control structures.

In other streams, especially in the larger ones, grade control structures may be designed to tie into the intermediate channel banks of the floodplain terraces that may have a capacity less than the 100 year peak flow. This concept is depicted in Figure 8-17. The grade control structures may have a capacity of a 20-year, 2-year, or just a bankfull channel event.



**Figure 8-17. Bankfull channel grade control structures**

Drop structures with capacities less than the 100-year event must be thoroughly analyzed to verify acceptable performance and stability during the 100-year event within the drop structure itself and in the adjacent terrace areas that will experience flow during the 100-year event. Often, the cutoff wall or sheet piling for a drop structure with a capacity less than the 100-year event will be extended substantially beyond the limits of the drop structure, sometimes to the limits of the 100-year floodplain.

Like the first profile of Figure 8-16, the longitudinal profile for bankfull drop structures reflects a bankfull channel longitudinal slope that is flatter than the longitudinal slope of the adjacent floodplain terraces. The depth of the bankfull channel varies and is typically at a minimum just upstream of a grade control structure and a maximum just below a drop structure; however, since drop structure spacing is typically more frequent for bankfull channel drop structures than full-width drop structures, the variation in channel depth is typically less. Bankfull channel drop structures are generally designed to drown out during large, infrequent floods such as the 100-year event and thus hydraulic jumps are not shown.

**Drop structure height.** In general, more frequently spaced low-height drop structures work best for flows smaller than the 100-year event. The most appropriate height should be verified through hydraulic analyses but may be less than a foot in height up to two feet. These small drop structures create less energy to dissipate, are better for fish passage integration, and can frequently be shown to drown out at higher flows, as shown in the profile of Figure 8-17. Figure 8-14 provides an example of how low-height drop structures can be incorporated into stream restoration design; it shows how drop structures in natural sand or cobble streams can consist of rock riffles located at crossovers between meander bends.

### **Stream Restoration Principle 5: Develop Grade Control Strategy to Manage Longitudinal Slope**

#### **Representative Design Tasks and Deliverables**

1. Document estimate of long-term equilibrium slope used for drop structure spacing and its basis.
2. Describe rationale for selection of bankfull channel grade control structures or full-width structures, design capacity, heights of drops, and types of drops.
3. Confirm if fish passage is applicable and provided.
4. Document hydraulic design of grade control structures (refer to Sections 4.8, 7.0, and Hydraulic Structures chapter).
5. Provide design drawings showing grade control structures in plan, profile, section, and details.

## 4.6 Address Bank Stability

Existing steep, unstable banks at the edges of the bankfull channel or at outer channel banks should be addressed. Consider the following methods in the order that they are presented:

- Vegetation measures.
- Bioengineering measures that strategically combine vegetation with various means of reinforcements such as coir blankets, willows in various configurations, turf reinforcement mats (TRMs), or soil- or void-filled riprap.
- Structural measures such as riprap and boulders.

### 4.6.1 Bioengineering Techniques

Over the course of decades, the practice of stream restoration within UDFCD has evolved from the use of structural measures to an approach that first considers vegetation, then bioengineering techniques prior to hard structural measures. UDFCD promotes the integration of bioengineering techniques into stream restoration design when the use of these measures is consistent with the policies concerning flow carrying capacity, stability, and maintenance.

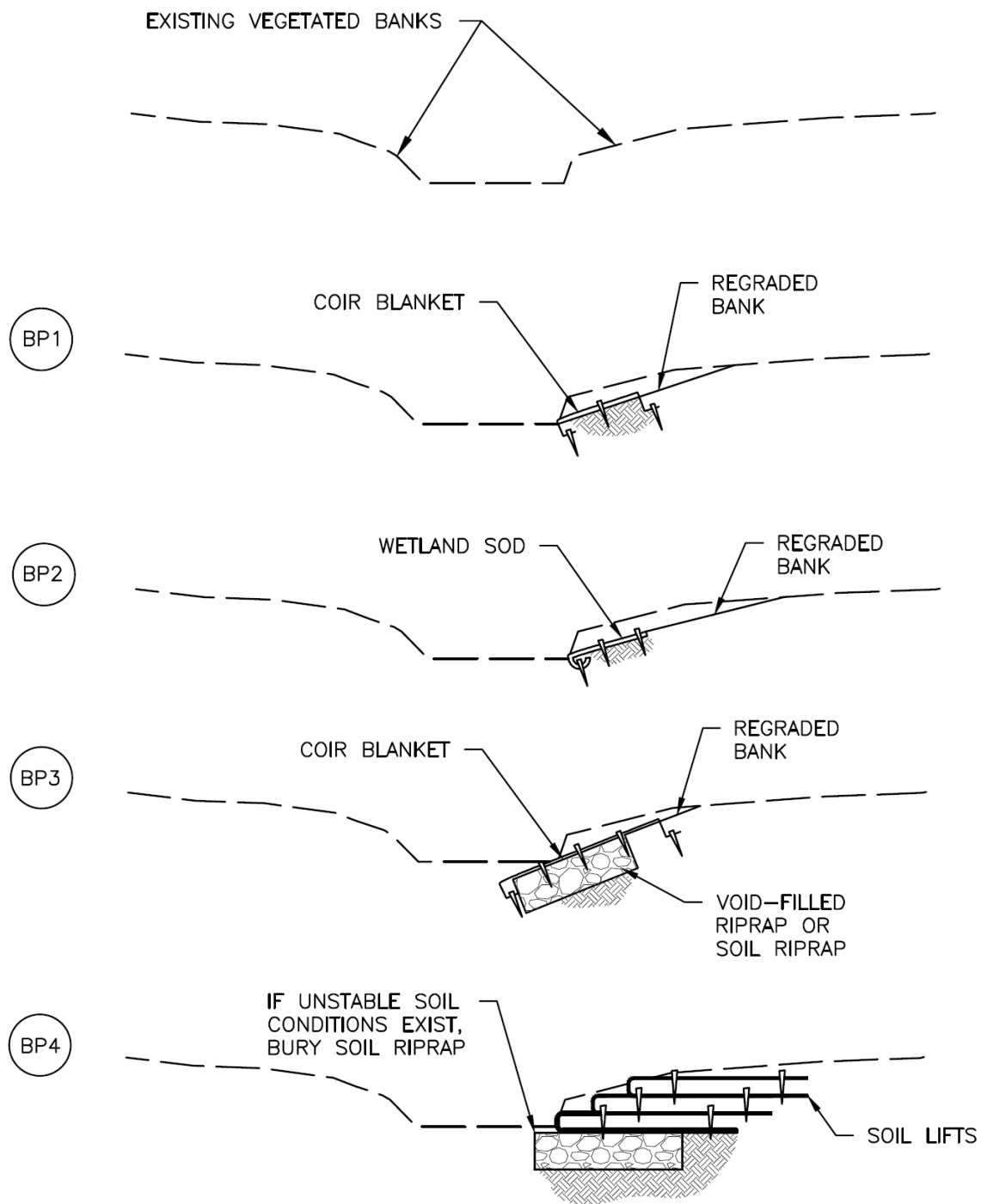
Compared to structural measures alone, vegetation and bioengineering appear more natural in character, enhance habitat, increase roughness to reduce velocities, may be of lower cost, and can create a living system that becomes stronger with time. On the other hand, care is necessary to select methods and vegetation suited to the hydrology of the stream, increased roughness of mature vegetation reduces flood conveyance capacity, and during the early years of establishment the risk of damage from large flood events may be greater than if more extensive structural measures are used. Many bioengineered stream restoration efforts have failed because the designer underestimated the stream power during large runoff events, or the likelihood of such events occurring during the vulnerable first several years of the newly established vegetation.

The advantages and risks of bioengineering techniques need to be taken into account by designers when selecting bank protection measures. As mentioned in Section 4.1, observing and understanding existing bank conditions, flow characteristics, causes of existing erosion, the potential for future erosion, and the proximity of infrastructure or property that could be impacted are necessary to design appropriate bank protection.

### 4.6.2 Bank Protection Approaches

Figure 8-18 shows several example approaches for protecting unstable banks along the bankfull channel. Photographs 8-11 through 8-16 illustrate a number of bioengineering approaches.

Because bank erosion may be more pronounced on the outside of bends, treatments may differ between the outside and inside. Treatments shown in Figure 8-18 generally apply to the outside bank. However, depending on stream conditions, any of these bank treatments may be implemented on the inside bank as well.



**NOTES:**

1. BANK PROTECTION TREATMENTS ARE SHOWN APPLIED TO RIGHT BANKS, BUT ARE APPLICABLE TO TO EITHER BANK.
2. TREATMENT SHOWN ARE FOR SCHEMATIC PURPOSES ONLY. THE DESIGNER IS RESPONSIBLE FOR FINAL DESIGN OF ALL TREATMENT INCLUDING STAKING PATTERNS, ROCK SIZING, ETC.

**Figure 8-18. Example low-flow channel bank protection treatments**



**Photograph 8-11.** Bioengineering techniques for channel stabilization immediately following construction.



**Photograph 8-12.** Same view as photo 8-11, one year after construction.



**Photograph 8-13.** Coir blanket used to protect the outside banks of a low-flow channel immediately following construction.



**Photograph 8-14.** (Same view as photo 8-13) Dense established vegetation.



**Photograph 8-15.** Soil lifts used to stabilize banks of low-flow channel. Photo taken immediately after construction.



**Photograph 8-16.** (Same view as photo 8-15 taken one year following construction.)



Severe bank erosion can occur when a low-flow channel migrates into a high outer bank, undermining the toe of the bank and causing a steep eroded face. Figures 8-19A and 8-19B show a number of examples for stabilizing and protecting this type of bank erosion. Like Figure 8-18, the bank protection approaches shown on the right side typically represent the outside bank.



**Photograph 8-17.** Void-filled riprap used to stabilize the low-flow channel.

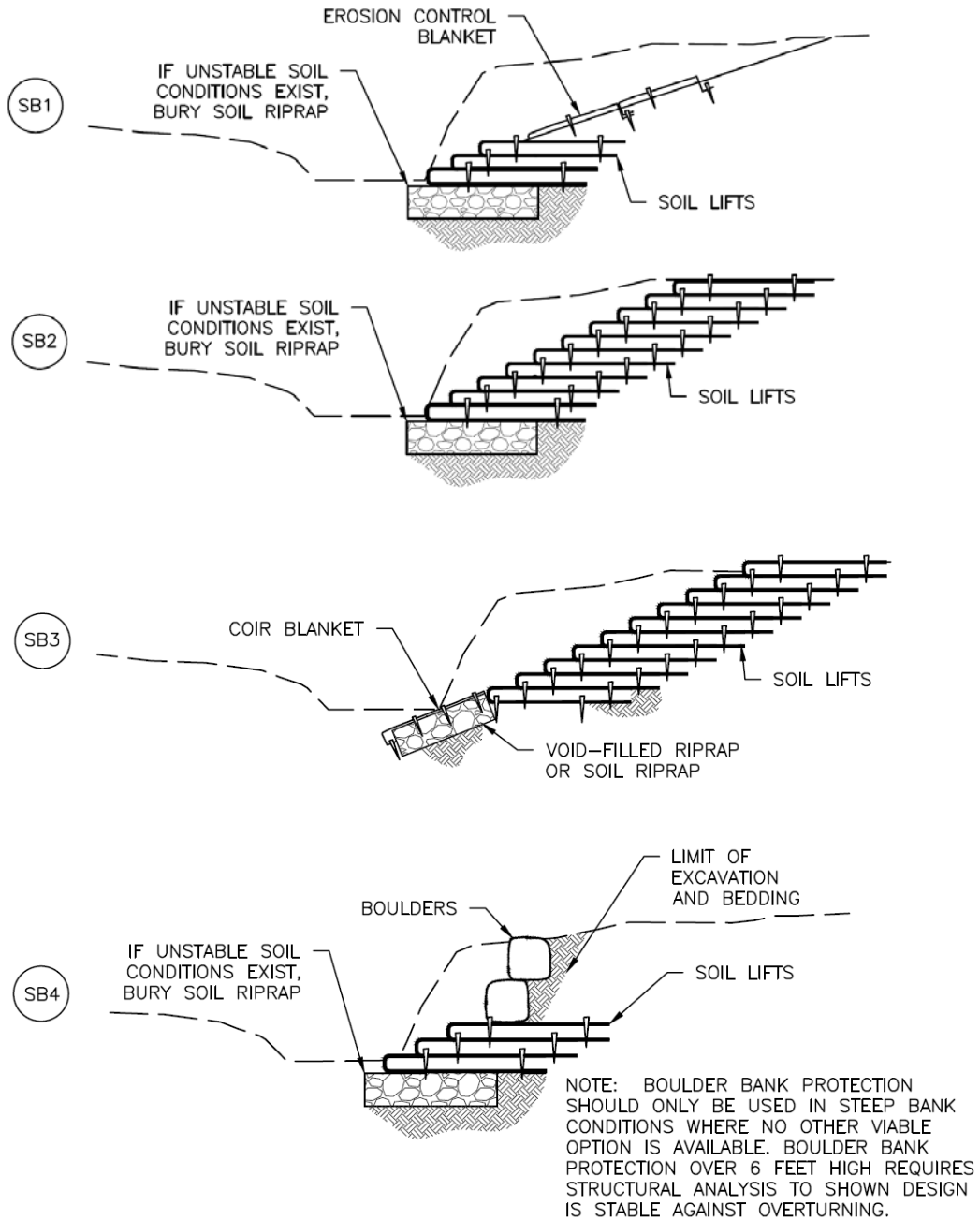
Designers must weigh the imposed shear stresses during floods of various magnitudes and locations to the resistive shear of the vegetation and soil. Methodology for assessing shear resistance of vegetation is discussed in Section 4.7. UDFCD recommends using purely vegetative treatments when the vegetation can provide adequate protection for the bank. In areas where immediate protection is required, this approach may include the use of wetland sod. Bioengineered solutions such as soil lifts (see Figure 8-20), can be used to offer a higher level of protection in the initial years after construction, allow steeper construction, and also help establish vegetation. The material used for typical soil lift construction consists of a combination of coconut fabric and coir. In some locations more “permanent” turf reinforcement mats can be used within a soil lift to withstand shear stress in excess of vegetation alone.

The use of soil-filled and void-filled riprap for bank protection should undergo hydraulic design using the methods described in Section 8.0. Rock and boulders can be used when vegetative and bioengineered practices won't provide adequate bank protection. UDFCD experience has shown that bank treatments relying on boulders tend to be more susceptible to scour and undermining; therefore, the use of boulders should be limited to entrenched channel conditions and tight radii where vegetative methods are viewed as less viable. Grouted boulders require adequate foundation and proper backfill. See Figure 8-36 for a detail. As shown in Figure 8-19A and 8-19B, boulder bank protection over six feet high requires structural analysis to demonstrate that the design is stable against overturning.

## **Stream Restoration Principle 6: Address Bank Stability**

### **Representative Design Tasks and Deliverables**

1. Describe rationale for selection of bank protection measures, considering vegetative, bioengineering, or structural approaches. Determine whether the stream's hydraulic response to extreme events makes it suitable for bioengineering and vegetative approaches. This includes consideration of shear stress during floods of various magnitudes.
2. Provide design drawings showing bank protection layouts in plan and section.
3. Provide supporting hydraulic calculations for selected bank protection.

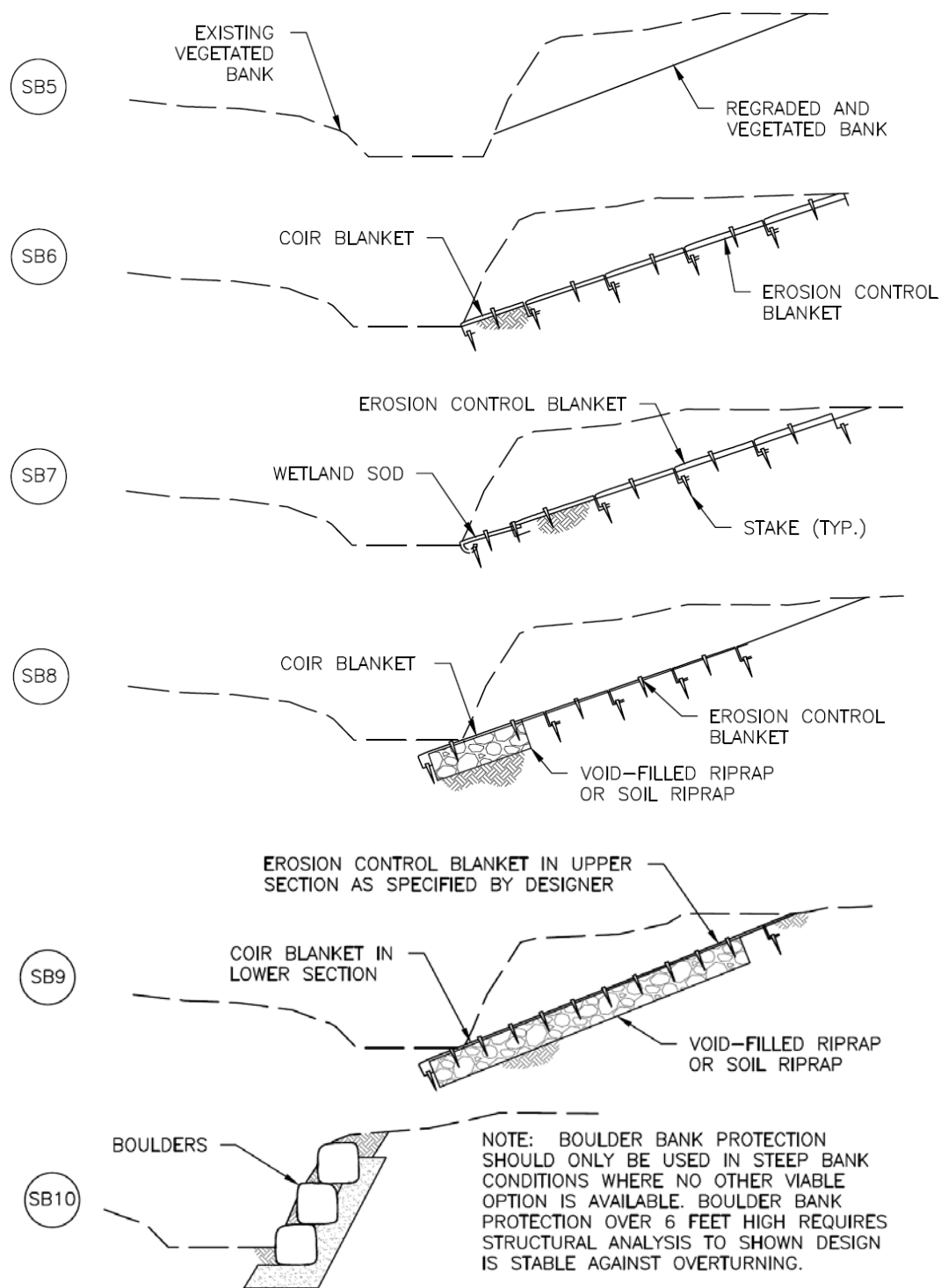


**NOTES:**

1. BANK PROTECTION TREATMENTS ARE SHOWN APPLIED TO RIGHT BANKS, BUT ARE APPLICABLE TO EITHER BANK.
2. TREATMENTS SHOWN ARE FOR SCHEMATIC PURPOSES ONLY. THE DESIGNER IS RESPONSIBLE FOR FINAL DESIGN OF ALL TREATMENT INCLUDING STAKING PATTERNS, ROCK SIZING, ETC.

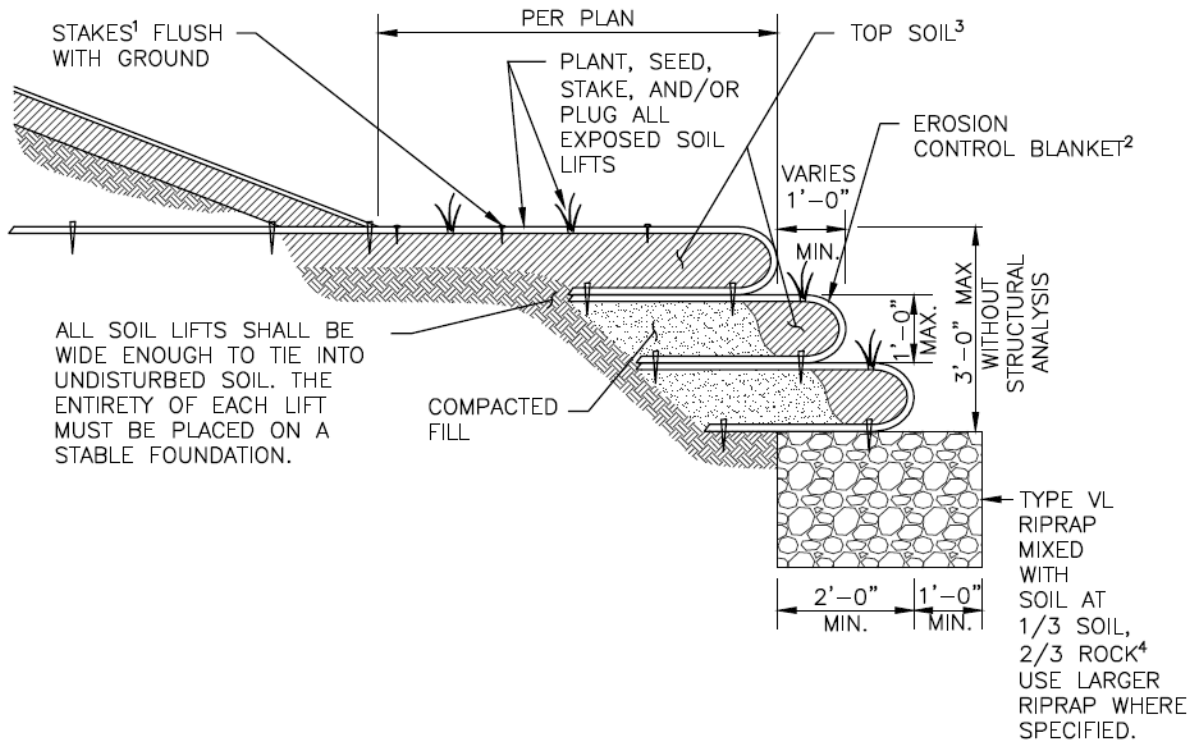
**Figure 8-19A. Example bank protection treatments for steep eroded banks**





- NOTES:**
1. BANK PROTECTION TREATMENTS ARE SHOWN APPLIED TO RIGHT BANKS, BUT ARE APPLICABLE TO TO EITHER BANK.
  2. TREATMENTS SHOWN ARE FOR SCHEMATIC PURPOSES ONLY. THE DESIGNER IS RESPONSIBLE FOR FINAL DESIGN OF ALL TREATMENT INCLUDING STAKING PATTERNS, ROCK SIZING, ETC.

**Figure 8-19B. Example bank protection treatments for steep eroded banks**



1. SEE FIGURE 13-5 IN REVEGETATION CHAPTER.
2. SPECIFY MATERIALS BASED ON HYDRAULIC CONDITIONS. MINIMIZE SEAMS, SPECIFYING MATERIAL WITH A WIDTH WIDE ENOUGH TO PLACE FABRIC PARALLEL TO FLOW. ALL FABRIC SHOULD BE PLACED TIGHT TO SOIL.
3. SEE REVEGETATION CHAPTER.
4. RIPRAP MAY NOT BE REQUIRED IN ALL LOCATIONS. THIS MAY BE ELIMINATED WHERE HYDRAULIC CONDITIONS DO NOT WARRANT RIPRAP AND THE ENGINEER DETERMINES SUBGRADE TO BE STABLE.

**Figure 8-20. Sample soil lift section**

## 4.7 Enhance Streambank and Floodplain Vegetation

As described in Section 4.6 in relation to bioengineering approaches, it is desirable to re-establish or supplement vegetation in stream corridors, especially along the banks of the low-flow channel and on the adjacent floodplain terraces to build up a sturdy, durable cover to help retard flood flows, resist erosion, and enhance habitat. Establishing a relatively shallow bankfull channel as described in Section 4.3 can help maintain a shallow water table favorable for terrace vegetation.

Deep-rooted riparian grasses such as Prairie Cordgrass, sedges, rushes, and other herbaceous species can provide excellent shear resistance to protect streambanks and floodplain terraces. Willows possess an amazing ability to root and thrive in streamside environments and are an important element in bioengineered bank protection; however, it is desirable to create a diverse mix of herbaceous species, woody shrubs, and trees within the floodplain and to avoid establishing a dominant monoculture of willows. Willows can also create a very dense stand of vegetation that may ultimately impact flood conveyance.

Analysis of the stability of grass lined channels should be completed using the stability procedures documented in the Agricultural Research Service (ARS) *Agricultural Handbook Number 667* (hereinafter referred to as *Handbook #667*). Developed in 1987, *Handbook #667* includes comprehensive methods for evaluating shear stress on grass and the underlying soil based upon grass height, density and soil type.

U.S. Army Corp. of Engineers, through its Ecosystem Management and Restoration Research Program (EMRRP), also provides a good resource for evaluating shear stress for a number of different channel lining methods in *Stability Thresholds for Stream Restoration Materials* (Fischenich 2001). Another resource for shear stresses of various vegetation and bioengineering methods is Table TS14I-4 in Technical Supplement 14I, *Streambank Soil Bioengineering* (USDA 2007).

The soil compaction effects of heavy equipment engaged in stream restoration work must be mitigated to help revegetation efforts. Compacted ground must be thoroughly deep-tilled and topsoil previously stripped and stockpiled needs to be replaced and fine-graded in disturbed areas prior to seeding and planting. If inadequate existing topsoil is available, topsoil meeting specified agronomic characteristics should be imported.

### Bioengineering Tips

1. When using blankets or mats parallel to the channel, avoid grade breaks in the middle of the blanket or mat run. Consider using soil wraps at these locations to provide better channel definition.
2. Ensure blankets and mats meet manufacturers' shear stress and velocity limits under critical flows in an unvegetated state. Use a safety factor as these tests are not typically performed for extended durations. (Fischenich 2001)
3. In areas subject to flow, blankets must be installed to hold the seed and soil in place. Placing seed and then straw and staking coir fabric over the straw is commonly used to achieve this. See the *Revegetation* chapter for a detail.
4. Consider using larger wooden stakes at toes and in trenches while using biodegradable stakes through the middle and upper sections of blankets and mats. This reduces obstacles for maintenance operations and recreational users.
5. Consider the area where the bank meets the channel bottom carefully. Reinforcement with wetland sod, willow logs, etc. can help ensure success.

Because of the challenges involved in getting vegetation established in areas disturbed by construction as well as the importance of early establishment to the function of a stream, follow-up activities must be planned over a several-year period to nurture vegetation efforts. Activities such as weed control, supplemental watering, reseeding, and replanting need to be planned, budgeted, and executed diligently to help disturbed areas fully recover and be protected with a healthy, varied mix of riparian vegetation. Streams that are constrained in terms of flood capacity require periodic maintenance activities to thin floodplain vegetation and reduce roughness.

Chapter 12, *Revegetation*, provides detailed guidance regarding revegetation efforts in stream corridors.

### **Stream Restoration Principle 7: Enhance Streambank and Floodplain Vegetation**

#### **Representative Design Tasks and Deliverables**

1. Identify areas of existing riparian vegetation that will be preserved and fenced off during construction.
2. Document approach and rationale for revegetation, identifying general seed mixes and types of plantings. Confirm that hydrology is suitable for vegetation selected.
3. Provide design drawings showing a detailed vegetation plan, including seed mix and planting details and specifications for loosening compacting disturbed soils and establishing adequate topsoil.

## 4.8 Evaluate Stream Hydraulics of over a Range of Flows

Detailed hydraulic modeling of stream corridors with proposed restoration improvements is required to assess flow depths, velocities, Froude number, imposed shear stress and other relevant parameters. The hydraulic analysis should consider a range of flows including the bankfull discharge, 2-year, 10-year, 100-year, and perhaps other intermediate and larger flows.

Section 7.0 provides guidance for conducting hydraulic modeling. The hydraulic modeling provides important information to guide the design of stream restoration improvements. It is recommended that hydraulics be evaluated for three conditions:

1. Baseline conditions reflecting estimated historic, unconstrained channel configuration, vegetation, and pre-development flow rates, if such conditions can be estimated.
2. Existing channel conditions based on estimated future development flow rates.
3. Proposed conditions representing the designed stream restoration improvements.

In each case, hydraulic parameters should be summarized for average flow conditions in the channel as well as independently in the main channel and terraces. The following hydraulic summaries are recommended:

- Longitudinal profiles showing bed invert, any grade control structures, and water surface profiles for a range of return periods.
- Longitudinal summaries of flow velocities and shear stress for the main channel and left and right terraces referenced to the same stationing as the profile information above.
- Cross section distributions of velocity and shear stress at representative locations along a design reach.

Section 7 provides guidance and examples of this hydraulic information. The overall goal is to use the information to assess in what ways and to what extent existing channel and hydraulic conditions depart from baseline conditions and to identify proposed stream improvements that create or restore healthy stream form, hydraulic conditions, and sediment equilibrium.

It is important to test the sensitivity of varied channel roughness – low roughness estimates for velocity and shear considerations and high roughness estimates for water surface determinations. Additional guidance on roughness estimates is provided in Section 7.0. Based on anticipated species and densities of vegetation and the in situ soil characteristics, it is necessary to confirm that imposed shear stress is less than shear resistance of soil/vegetation for the intended design event. Section 4.7 describes resources available to support these evaluations. In addition, rock sizing procedures are described in Section 8.0. The hydraulic analysis effort is normally iterative, requiring refinements to the design to obtain desired hydraulic conditions.

Table 8-1 summarizes desirable geometric and hydraulic design parameters for naturalized channels. This table should be used as a guide for determining the stability of a channel. The designer's experience and judgment are also an important aspect of determining channel stability. Although recommendations for maximum tractive force (or shear stress) are provided, the designer may elect to assess the resistive shear stress provided by terrace vegetation and soils and determine design limits specific to the project.

Since the subject of this Section 4 is restoring natural streams, it may be that the maximum prudent values for the hydraulic parameters shown in Table 8-1 are exceeded in the 100-year event even after the recommendations of subsections 4.1 through 4.8 are followed, including avoiding filling the floodplain, establishing a shallow bankfull channel with adjacent vegetated terraces, opening up constrictions, implementing grade control structures, and enhancing vegetation. The goal would be to come as close as

possible for as much of the reach as possible to the maximum prudent values for the hydraulic parameters in the 100 year event. The designer should determine the return period where these parameters would be achieved and, with the owner and local jurisdiction, determine if the associated risks are acceptable.

On the other hand, if the recommendation to avoid floodplain filling is not followed and fill is proposed, this should only happen in floodplains where the maximum prudent values for the hydraulic parameters shown in Table 8-1 are not exceeded in the 100-year event.

**Table 8-1. Maximum prudent values for natural channel hydraulic parameters**

<b>Design Parameter</b>	<b>Non-Cohesive Soils or Poor Vegetation</b>	<b>Cohesive Soils and Vegetation</b>
Maximum flow velocity (average of section)	5 ft/s	7 ft/s
Maximum Froude number	0.6	0.8
Maximum tractive force (average of section)	0.60 lb/sf	1.0 lb/sf
Maximum depth outside bankfull channel	5 ft	5 ft

### **Stream Restoration Principle 8: Evaluate Hydraulics of Streams over a Range of Flows**

#### **Representative Design Tasks and Deliverables**

1. Document hydraulic analyses of the project reach following the guidance of Section 7.0.
2. Describe how hydraulic performance of the project reach compares to maximum prudent values for the hydraulic parameters shown in Table 8-1 for several return periods (including 2-, 10-, and 100-year events at a minimum). Describe any locations in the reach where these parameters are exceeded and discuss efforts made to improve hydraulics.
3. Confirm that hydraulic parameters of Table 8-1 are satisfied in for the 100-year event in all locations where fill is proposed in the floodplain.

## 5.0 Naturalized Channels

Natural channels may not be well-defined in upland tributary areas and it may be necessary to construct new channels “from scratch.” By applying principles from Section 4, new surface channels can be created that emulate natural streams and, over time, may take on the appearance and functions of natural streams with supporting vegetation and biota. The criteria and techniques presented in this section may also be used on some existing stream reaches where existing urban constraints are limiting.

Naturalized channels do not have concrete trickle channels and are generally not intended to be vegetated with irrigated sod; rather, native grasses and riparian species are recommended. Vegetation at the edges of the low-flow channel and in the adjacent floodplain terraces is generally not intended to be mowed to a low height. Current criteria in this manual do not address bare rock riprap-lined channels or concrete-lined channels, since these are not recommended as typical channel treatments. Design guidelines for these types of channels can be found in other manuals.

The eight stream restoration principles from Section 4 apply directly to the design and construction of naturalized channels. These are summarized below; the designer is encouraged to review the applicable information in the corresponding Sections 4.1 through 4.8.

### 5.1 Understand Existing Stream and Watershed Conditions

For naturalized channels, the goal of this principle is to locate candidate reference reaches that have desirable geometric, hydraulic, and vegetative characteristics that can be used as a guide for the design of the project reach. Ideally, reference reaches would serve about the same upstream area and convey similar flow rates; however, desirable reference reaches serving larger or smaller areas may be able to be scaled to match the design flows of the naturalized channel. In many cases however, no applicable reference reach will exist, in which case the bankfull channel sizing methods described in Section 4.3.2 should be applied.

Researching design flows and understanding characteristics of the watershed upstream of the naturalized channel involves the same types of information and yields the same benefits as described for natural streams in Section 4.1. As a first step, every effort should be made to apply runoff reduction methods in upstream watershed areas. The more runoff reduction upstream, the lower the range of flow rates, velocities, and shear stresses, the less structural the stream improvements need to be and the higher the water quality of runoff. The relative increase in flows from pre-development conditions to future build-out are to be evaluated as part of understanding the existing stream and watershed conditions for the naturalized channel.

#### Remember Permitting Requirements

The environmental permitting process benefits greatly from early and close coordination with the US Army Corps of Engineers. Environmental firms experienced in 404 permitting not only make the process efficient and successful but provide valuable expertise on restoration projects. The stream restoration principles described in this chapter represent good practice and are consistent with the intent of the 404 permit system to protect waters of the US. In addition, Endangered Species Act (ESA) requirements must be addressed for Conditional Letters of Map Revisions

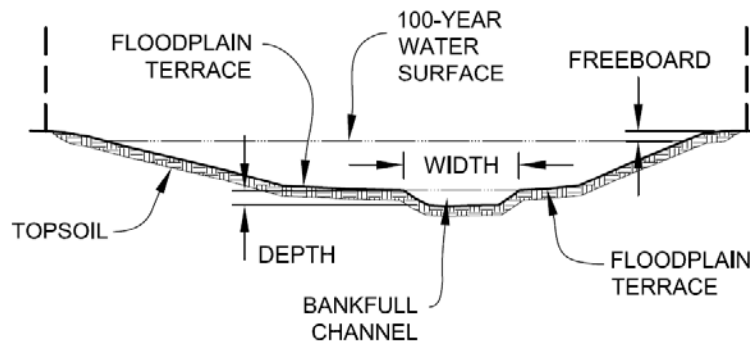
These projects also frequently require Federal Emergency Management Agency (FEMA) map changes. See the *Flood Risk Management* chapter for guidance.

## 5.2 Apply Fluvial Geomorphology Principles to Manage Sediment Balance

While sediment loading may not be a design consideration for naturalized channels draining small watersheds, it is still advisable to consider sediment movement and fluvial channel characteristics. A relatively small upstream drainage area combined with a low sediment load may translate into a channel that can support vegetation across the bottom of the bankfull channel. This type of channel may resist bed degradation better than an unvegetated channel bottom and therefore be able to maintain a slightly steeper longitudinal slope, driven less by a need to control baseflow erosion and more by the desired overall channel hydraulics in the design storm.

## 5.3 Establish Effective Cross-Sectional Shape

Creating a properly sized bankfull channel with adjacent vegetated floodplain terraces is a critical element in the design of naturalized channels. Sizing of the bankfull channel as described in Section 4.3.2 can be applied to these channels; however, Table 8-2 provides minimum dimensions for bankfull channels and floodplain terraces in naturalized channels. Figure 8-21 defines the geometry addressed in Table 8-2 for a naturalized channel.



**Figure 8-21. Typical naturalized channel geometry**

The bankfull channel in naturalized channels should be sized to convey at least 70% of the future development 2-year flow or 10% of the future development 100-year flow, whichever is greater. In addition to the minimum dimensions shown in Table 8-2, a maintenance access path with a minimum per the geometry listed in Table 9-3 of the *Stream Access and Recreational Channels* chapter.



**Table 8-2. Minimum dimensions for naturalized channels<sup>1</sup>**

<b>Bankfull Channel Depth, ft</b>	<b>Minimum Bankfull Channel Width, ft</b>	<b>Minimum Floodplain Terrace Width (average each side), ft</b>
0.5	6	6
1.0	10	8
1.5	14	10
2.0	18	12
2.5	24	16
3.0	30	20

<sup>1</sup> Values are based on a desired entrenchment ratio between 3 and 4. Based on several scenarios modeled in HEC-RAS, the values in this table, when paired with the criteria in Table 8-3, produce generally favorable hydraulics.

As in natural streams, channel vegetation and roughness will increase over time and long-term sediment deposition could raise the bed of the channel. Therefore, conservatively high roughness values should be used for assessing flow depths (per Section 7.0) and a freeboard of 18 inches or more should be considered.

#### **5.4 Maintain Natural Planform Geometry**

The planform of naturalized channels can be created to emulate features of natural reference reaches. As was discussed in Section 4.4, natural streams offer variety and complexity in form; they are seldom straight and uniform. Outer banks move in and out and bank heights, slopes, and widths vary. Bankfull channels exhibit a degree of meandering and sinuosity, moving right and left across a section in an alternating manner. The shape of the low-flow channel varies, tending to widen slightly in bends and narrow in riffles between bends; side slopes tend to steepen at the outside of bends and flatten as point bars form on the inside of bends. All of these characteristics can be reflected in naturalized channels.

Care should be taken to avoid sharp bends in the channel. A radius of curvature at least two times the channel top width is recommended, although ratios of three or four times top width are preferable.

#### **5.5 Develop Grade Control Strategy to Manage Longitudinal Slope**

If the grading adjacent to a channel can be made to match the design slope of the channel, the need for drop structures may be eliminated. If the adjacent grade is steeper than the design slope, grade control in the channel will be necessary. For small channels, grade control structures will most often extend across the full channel section and the grade of the floodplain terraces will typically be configured to match the design slope of the bankfull channel invert. Section 4.4 should be referred to for design guidance regarding the height and spacing of drop structures.

## 5.6 Address Bank Stability

Constructed naturalized channels will not typically have extensive bank erosion problems to address; however, bank protection for low-flow channel banks or outer banks may be incorporated into the design, particularly on the outside of bends. Bank protection measures can be determined based on the options identified in Section 4.6. Bioengineering applications for bank protection may be considered for naturalized channels given acceptable hydraulic response (e.g., stream power) to extreme events.

## 5.7 Enhance Streambank and Floodplain Vegetation

The naturalized channel should be seeded and planted with herbaceous and woody species appropriate for anticipated hydrologic conditions in zones adjacent to the bankfull channel as described in Section 4.7 and the *Revegetation* chapter of this manual. It is critical that the soil compaction effects of heavy equipment be mitigated to help revegetation efforts. Compacted ground must be thoroughly deep-tilled, amended and topsoil previously stripped and stockpiled needs to be replaced and fine-graded in the channel prior to seeding and planting.

In addition, a post-construction maintenance phase should be planned for watering, weed control, and supplemental seeding/planting to ensure vegetation establishment.

### Topsoil

Topsoil is a valuable resource. Where present, remember to strip, stockpile and use this material. Because of the importance of favorable soil characteristics for plant health, naturalized channel projects may call for 12 inches of topsoil for the full width of the channel. See the *Revegetation* chapter for additional recommendations.

## 5.8 Evaluate Stream Hydraulics over a Range of Flows

Conduct detailed hydraulic modeling of naturalized channels, applying low roughness estimates for velocity and shear considerations and high roughness estimates for water surface determinations, as described in Section 7.0. Confirm that imposed shear stress is less than the shear resistance of soil/vegetation for the intended design event and refine the design to obtain the hydraulic conditions identified in Table 8-3, below. Note that the parameters listed in this table assume cohesive soils and vegetation; however, it is recommended that these values be satisfied for roughness conditions that will exist immediately after construction.

**Table 8-3. Design parameters for naturalized channels**

<b>Design Parameter</b>	<b>Design Value</b>
Maximum 100-year depth outside of bankfull channel	5 ft
Roughness values	Per Table 8-5
Maximum 5-year velocity, main channel (within bankfull channel width) (ft/s)	5 ft/s
Maximum 100-year velocity, main channel (within bankfull channel width) (ft/s)	7 ft/s
Froude No., 5-year, main channel (within bankfull channel width)	0.7
Froude No., 100-year, main channel (within bankfull channel width)	0.8
Maximum shear stress, 100-year, main channel (within bankfull channel width)	1.2 lb/sf
Minimum bankfull capacity of bankfull channel (based on future development conditions)	70% of 2-year discharge or 10% of 100-yr discharge, whichever is greater <sup>1</sup>
Minimum bankfull channel geometry	Per Table 8-2
Minimum bankfull channel width/depth ratio (Equation 8-3)	9
Minimum entrenchment ratio (Equation 8-4)	3
Maximum longitudinal slope of low flow channel (assuming unlined, unvegetated low flow channel)	0.2 percent
Bankfull channel sinuosity (Equation 8-5)	1.1 to 1.3
Maximum overbank side slope	4(H):1(V)
Maximum bankfull side slope	2.5(H):1(V)
Minimum radius of curvature	2.5 times top width

<sup>1</sup>Roughly equivalent to a 1.5-year event based on extrapolation of regional data.

## 6.0 Swales

The functions and benefits of natural streams can be extended further upstream in the watershed by conveying runoff on the surface in vegetated channels and swales rather than in underground storm drains. Besides the aesthetic and habitat value of surface channels, stormwater quality can be enhanced by promoting beneficial interaction between water, soil, and vegetation. Conveyance in storm drains produces no such interaction or water quality enhancement.

Guidance is provided in this subsection for the design of swales, draining areas from less than an acre up to about 10 impervious acres (e.g., 20 acres at 50% imperviousness). A series of design charts are provided to guide the designer in determining stable conditions in vegetated or void-filled riprap swales of varying cross sections based on design flow rate and slope. The charts show flow rates as high as 100 cfs (stable at relatively flat slopes) and slopes as steep as 10 percent (stable at relatively low flows). It should be noted that the design criteria in this section differs from those in *Volume 3* of this manual. *Volume 3* criteria are intended to provide a higher level of water quality treatment. These criteria are intended for stable conveyance more so than water quality benefits.

## 6.1 Design Criteria for Swales

Design criteria are described for grass and rock (soil riprap or void-filled riprap) swales. Where indicated by Figures 8-22 through 8-25, grass swales meeting these criteria are preferred, but when conditions require, swales lined with soil riprap or void-filled riprap are advisable.

In order to maximize the use of grass swales, and increase the likelihood that the swale will remain functional and stable over time, two key design principles should be considered.

1. **Adopt shallow swale section with flat bottom.** Swale cross sections that allow runoff to spread out (shallow, flat bottom with gentle side slopes) promote lower velocities and shear stresses than triangular (or “V” shaped) swales. This is also good for water quality. In general, the wider the bottom width of the swale, the more stable it will be, although concentrated flow paths may still form. It is generally recommended that swales be of a trapezoidal shape with a bottom width of 2 feet or more and with side slopes that are 5:1 or flatter.
2. **Establish dense turf-forming grass in suitable soils.** The single most important factor in creating stable grass swales is to establish a dense stand of turf-forming grass in the bottom and side slopes of the swale. This requires good soils or amendments and proper soil preparation and planting. Irrigation may also be necessary. See the *Revegetation* chapter for more information.

### 6.1.1 Stability Charts

Swale stability based on slope, flow rate, swale geometry, and grass or rock lining are shown graphically in Figures 8-22 through 8-25. Design guidance is provided in the stability charts for design discharges up to 100 cfs and for longitudinal slopes up to 10 percent. Although these figures go up to 100 cfs, it may be appropriate to design a more naturalized channel section for flow rates greater than 30 to 40 cfs. This is largely dependent on site-specific considerations. As already mentioned, steep swales are most feasible for small discharges while swales carrying large discharges are most feasible at flatter slopes. If the chart is indicating that riprap greater than Type H (see Figure 8-34) is required, a swale for those hydraulic conditions is not recommended. Typically, if Type H riprap is required, consider other options such as widening the swale or flattening the slope.

The use of Figures 8-22 through 8-25 for swale stability analysis requires that the geometric parameters indicated at the top of each chart apply and the requirements of Section 6.2 for grass swales and Section 6.3 for soil riprap or void-filled riprap are met.

Table 8-4 below summarizes the appropriate stability chart to reference based upon the swale geometry.

**Table 8-4. Summary of swale properties for stability chart reference**

Bottom Width	Side slope	Stability Chart
2 - 4 feet	between 5:1 and 10:1	Figure 8-22
2 - 4 feet	10:1 or flatter	Figure 8-23
greater than 4 feet	between 5:1 and 10:1	Figure 8-24
greater than 4 feet	10:1 or flatter	Figure 8-25

For swales outside the range of application of Figures 8-22 through 8-25, specific analysis of the

proposed swale parameters may be required. See Section 6.2 for additional guidance on determining the stability of grass swales. Analysis for riprap-lined swales should be completed using the methodologies discussed in Section 6.3.

## **6.2 Grass Swales**

### **6.2.1 Soil and Vegetation Properties**

The single most important factor governing the stability of grass swales is the quality of vegetation. Refer to the *Revegetation* chapter of this manual for proper site preparation including soil testing, topsoil, amendments, and recommendations for addressing soil compaction. The *Revegetation* chapter also provides recommended seed mixes. Turf-forming grasses that include a variety of species work best.

In addition to seeding, it is recommended that grass plugs of the dominant species in the seed mix be planted to provide some immediate vegetative cover and improve overall establishment. Place drier species on the side slopes. Placing sod is also an option for grass swales.

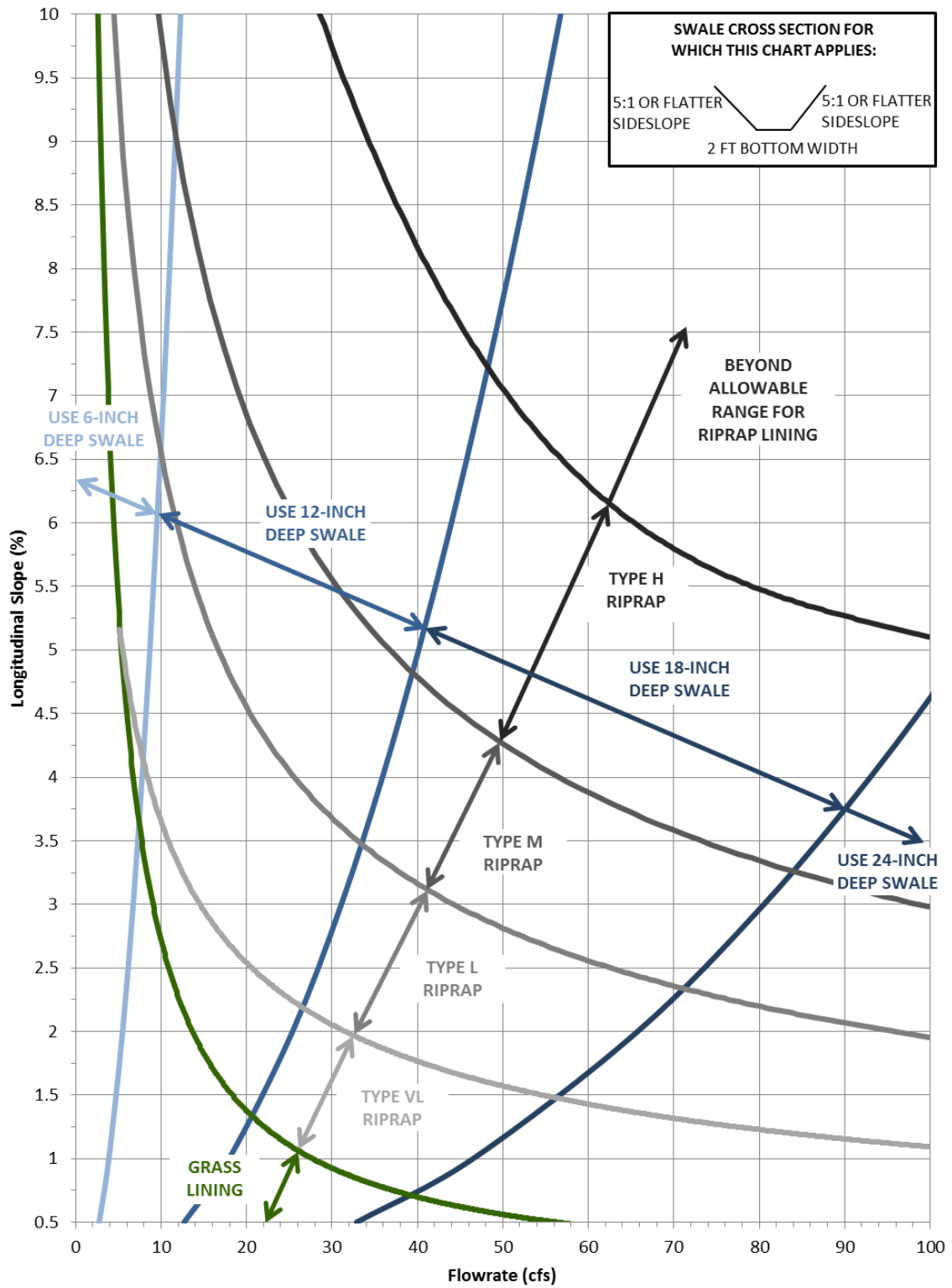
Discussion regarding the use of Handbook #667 for stability analysis of grass channels can be found in Section 4.7.

### **6.2.2 Construction**

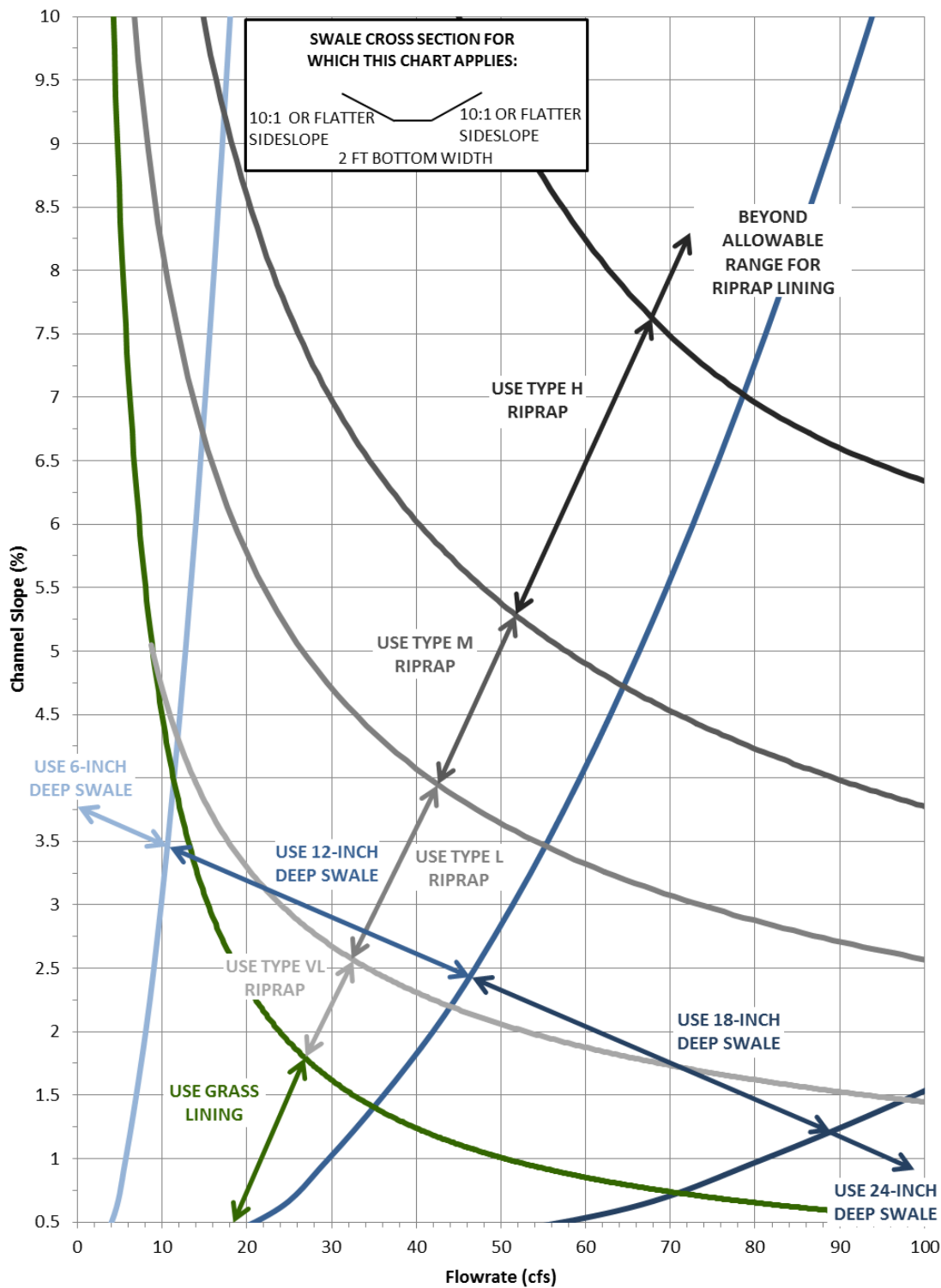
It is imperative that the construction drawings and specifications address seedbed preparation; installation of seed, blankets, and plugs; temporary irrigation; weed control; and follow-up reseeding and maintenance. Specific construction recommendations, including for submittals and inspections, can be found in the *Revegetation* chapter. Good temporary erosion controls are critical during establishment of vegetation.

## **6.3 Soil Riprap and Void-Filled Riprap Swales**

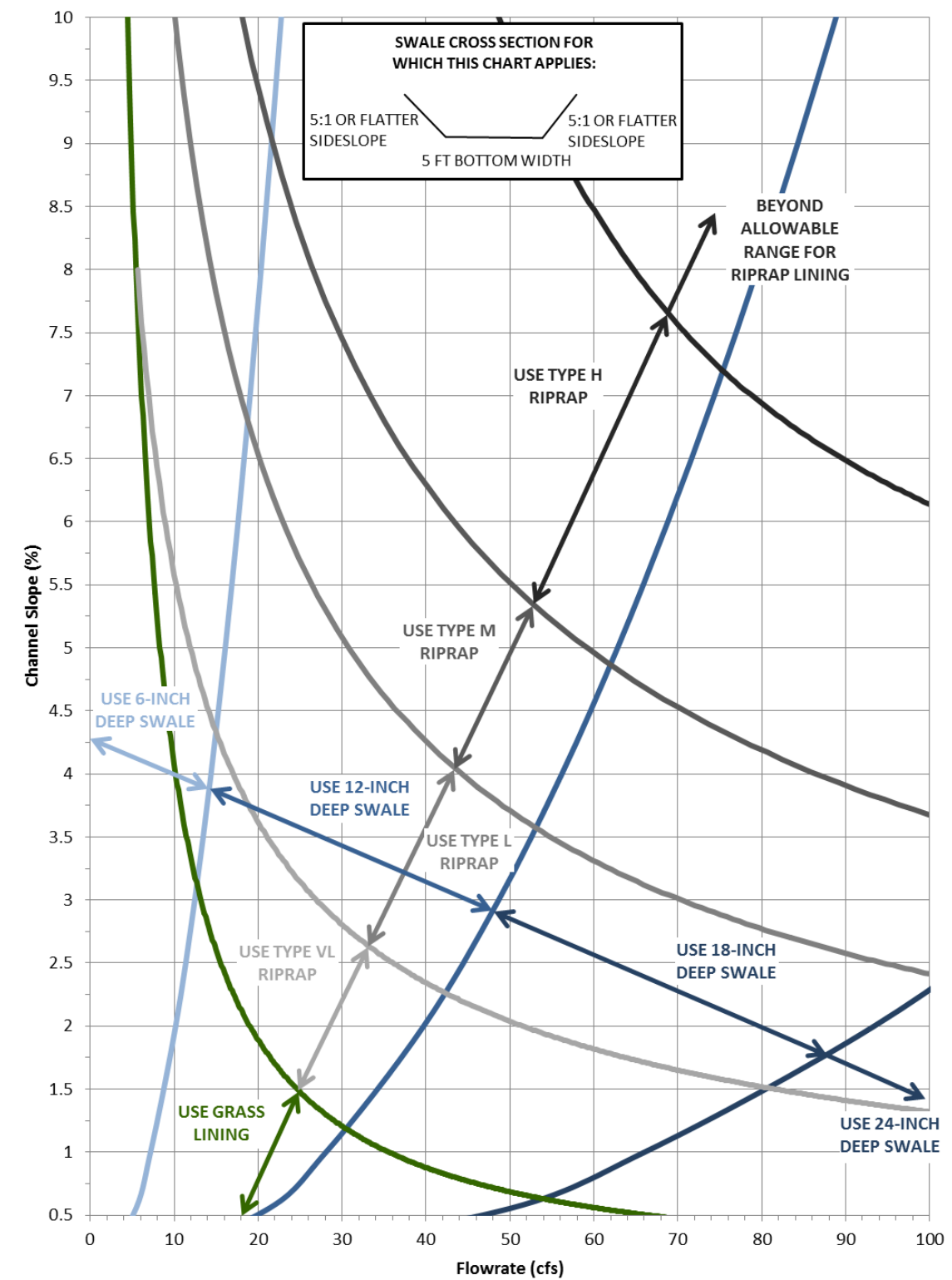
For swales that require riprap lining, use a soil riprap for void-filled riprap mix. Additional information is provided in Section 8.0. Use Figures 8-22 through 8-25 for final design only when the appropriate geometric parameters are met. Table 8-4 summarizes the appropriate stability chart based on swale geometry.



**Figure 8-22. Swale stability chart; 2- to 4-foot bottom width and side slopes between 5:1 and 10:1**  
 (Note: Riprap classifications refer to gradation for riprap used in soil riprap or void-filled riprap. See Figure 8-34 for gradations.) (Source: Muller Engineering Company)



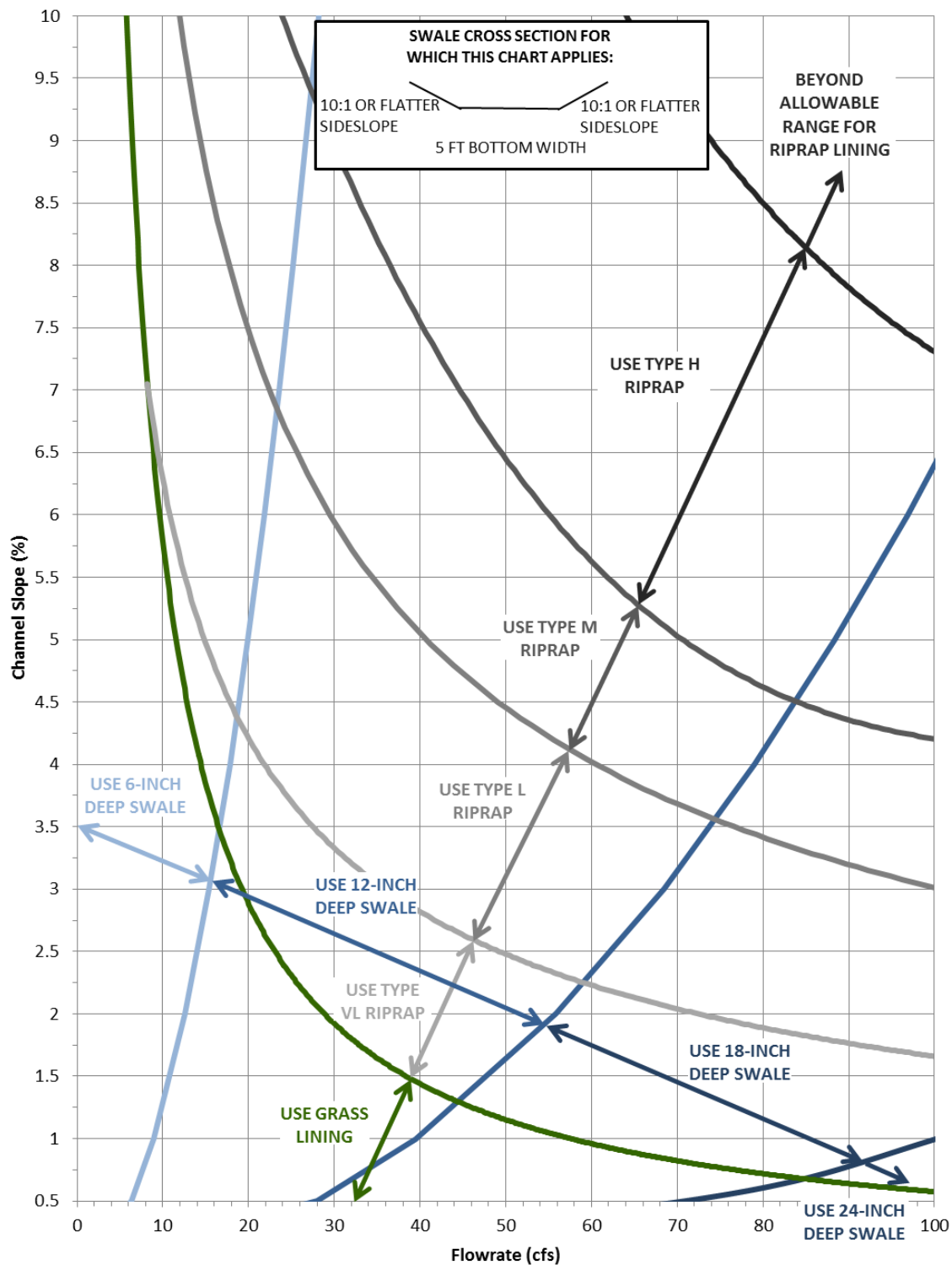
**Figure 8-23. Swale stability chart: 2- to 4-foot bottom width and 10:1 (or flatter) side slopes**  
 (Note: Riprap classifications refer to gradation for riprap used in soil riprap or void-filled riprap. See Figure 8-34 for gradations.) (Source: Muller Engineering Company)



**Figure 8-24. Swale stability chart: greater than 4-foot bottom width and side slopes between 5:1 and 10:1**

(Note: Riprap classifications refer to gradation for riprap used in soil riprap or void-filled riprap. See Figure 8-34 for gradations.) (Source: Muller Engineering Company)





**Figure 8-25. Swale stability chart: greater than 4-foot bottom width and 10:1 (or flatter) side slopes**  
 (Note: Riprap classifications refer to gradation for riprap used in soil riprap or void-filled riprap. See Figure 8-34 for gradations.) (Source: Muller Engineering Company)

## 7.0 Hydraulic Analysis

Evaluating channel and floodplain hydraulics is a key component of any stream project. Hydraulic modeling provides insight into flow properties including water surface elevation, depth, velocity, shear stress, and Froude Number. Understanding these flow properties is necessary to assess risks associated with structure flooding and channel erosion and can help guide the design of stream capacity and stabilization improvements.

### 7.1 Preliminary Channel Analysis

For detailed hydraulic analysis, hydraulic modeling software is recommended (i.e., HEC-RAS). There may be times when a preliminary or “quick” analysis is needed to evaluate channel properties in uniform steady flow conditions. For these cases, Manning’s Equation should be used. Manning’s Equation describes the relationship between channel geometry, slope, roughness and discharge for uniform flow conditions and is expressed as:

$$Q = \frac{1.49}{n} AR^{2/3} S^{1/2} \quad \text{Equation 8-6}$$

Where:

$Q$  = discharge (cfs)

$n$  = roughness coefficient (see Section 7.2.3)

$A$  = area of channel cross section (ft<sup>2</sup>)

$R$  = hydraulic radius =  $A/P$  (ft)

$P$  = wetted perimeter (ft)

$S$  = friction slope (ft/ft) (approximated by channel invert slope for normal depth calculations)

Manning's Equation can also be expressed in terms of velocity by employing the continuity equation,  $Q = VA$ , as a substitution in Equation 8-6, where  $V$  is velocity (ft/sec).

For wide channels of uniform depth, where the width,  $b$ , is at least 25 times the depth, the hydraulic radius can be assumed to be equal to the depth,  $y$ , expressed in feet, and, therefore:

$$Q = \frac{1.49}{n} by^{5/3} S^{1/2} \quad \text{Equation 8-7}$$

The solution of Equation 8-6 for depth is iterative, therefore using a software program to assist with this calculation can be beneficial. A number of additional software packages are available to solve Manning’s Equation by inputting known channel properties.

The designer should realize that uniform flow is more often a theoretical abstraction than an actuality (Calhoun, Compton, and Strohm 1971), namely, true uniform flow is difficult to find. Channels are sometimes designed on the assumption that they will carry uniform flow at normal depth, but because of ignored conditions the flow actually has depths that can be considerably different. Uniform flow computation provides only an approximation of the hydraulic conditions that will actually occur.

## 7.2 HEC-RAS Modeling

The most commonly used tool for open channel hydraulic modeling is the Hydrologic Engineering Center's River Analysis System (HEC-RAS) from the US Army Corps of Engineers. For the purpose of this chapter, discussion will focus on HEC-RAS's ability to perform one-dimensional steady flow analysis using a series of input parameters. Typical input parameters include flowrate, channel cross section geometry, roughness coefficients, main channel bank stations, etc. HEC-RAS has the capability to model bridges, culverts, weirs and spillways as well as address unsteady flow computations. In most cases, a subcritical HEC-RAS run is appropriate for natural channels since significant reaches of supercritical flow do not often occur in natural Front Range streams (Jarrett 1985). This section provides guidance on determining appropriate input parameters and reviewing output information when undertaking HEC-RAS modeling.

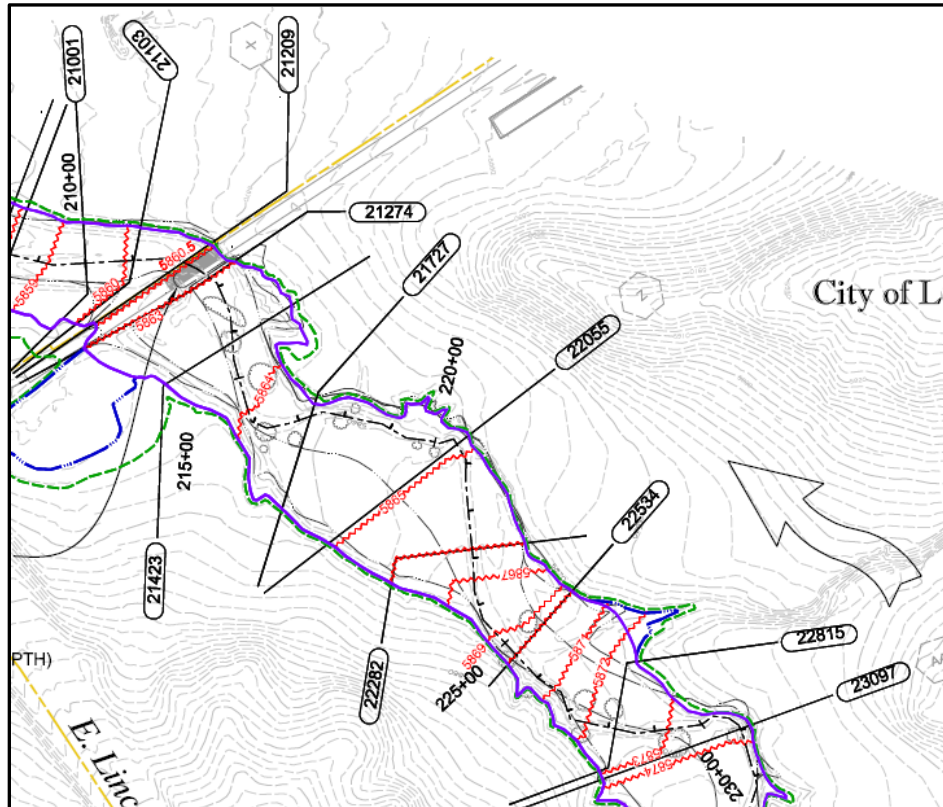
### 7.2.1 Cross Section Location

Cross sections should be placed relatively frequently along a channel reach in order to adequately evaluate the channel characteristics. Cross section placement should be governed by changes in discharge, channel width, slope, shape, roughness, and the location of hydraulic structures (bridge, culvert, grade control structure, etc.). Typical cross section spacing may be in the range of 200 to 400 feet or closer if conditions warrant. Refer to the *Hydraulic Structures* chapter and the *Culverts and Bridges* chapter guidance on cross section placement for grade control structures and bridges respectively. The HEC-RAS Hydraulic Reference Manual is an essential document to be familiar with when performing HEC-RAS analyses.

In addition to spacing of cross sections along a stream reach, the designer must consider the alignment of individual cross sections. Cross section should generally be oriented to be perpendicular to the channel centerline and the water flow path. At times it may be necessary to include deflections in the cross section in order to be perpendicular to flow in the channel terraces. Figure 8-26 illustrates an example of cross section placement and alignment to capture channel flow paths perpendicular to the cross section.

### 2D Flow Modeling

Two-dimensional hydraulic modeling is not addressed in this manual, although its use is becoming more widespread for evaluating complex hydraulic conditions. Guidance in this manual is limited to one-dimensional modeling using HEC-RAS. This is the primary tool for modeling stream restoration improvements.



**Figure 8-26. Example of HEC-RAS cross section placement and alignment**

## 7.2.2 Cross Section Geometry

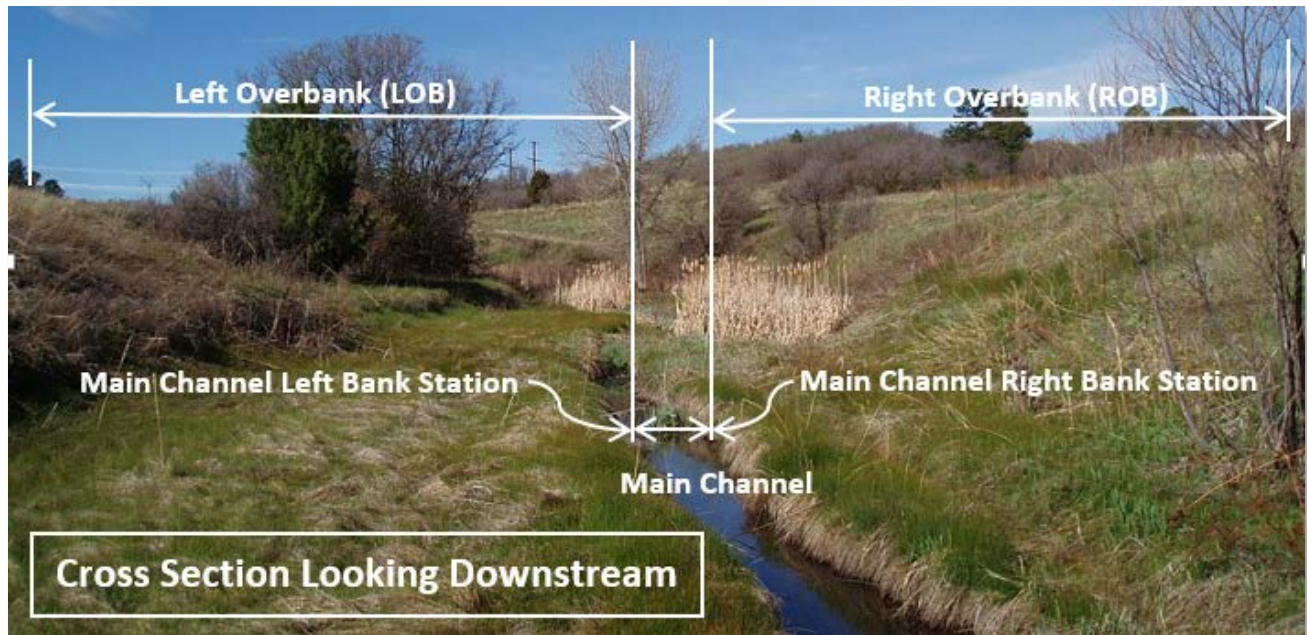
Required cross section input data includes station (x) and elevation (y) coordinates of the cross section, main channel bank stations, roughness coefficients, and contraction/expansion coefficients.

### Cross Section Coordinates and Main Channel Bank Stations

Entering cross section coordinates can be accomplished in several different ways. There are several software packages that can generate cross section data from a digital terrain model and import it directly. Cross sections can also be entered manually. Regardless of the method, it is critical that the input coordinates accurately represent the horizontal and vertical geometry of cross sections, so back-checking for quality assurance is recommended.

Once the station and elevation coordinates for the channel cross section have been input into HEC-RAS, the main channel bank stations must be determined. It is generally recommended that the main channel be interpreted as a relatively narrow portion of the cross section. Figure 8-27 illustrates the main channel and terraces in a typical cross section. The bankfull channel comprises the deepest part of the cross section, often has a lower roughness value than the vegetated terraces, and typically experiences the highest flow velocities. Sometimes, small headwater channels and especially swales may have a vegetated bankfull channel as a result of minimal or no baseflow.

Required input for HEC-RAS includes reach lengths to the next downstream cross section. The downstream reach length for the main channel is measured along the established channel centerline. The downstream reach lengths for the left and right overbank is measured following the flowpath of water in the overbanks from the centroid of flow in the overbank of one cross section to the centroid of flow in the next section downstream. This means that the overbank distance on the inside of the bend will be less than the overbank distance on the outside of the bend.



**Figure 8-27. HEC-RAS cross section definitions**

### 7.2.3 Roughness Coefficients

Required input also includes defining hydraulic roughness coefficients, or Manning's  $n$  values, for the main channel, left overbank and right overbank. For channel cross sections that are best described with varying values for Manning's  $n$  in the overbanks, the "Horizontal Variation in  $n$  Values" feature can be used. This feature allows the designer to specify a Manning's  $n$  value at each cross section coordinate.

Selecting roughness values for the main channel and overbanks of each cross section in the model is an important task. Because this tends to be somewhat subjective rather than deterministic, it is recommended that hydraulic modeling be conducted in two ways. Conservatively low roughness values should be used for assessing velocities, Froude numbers, and shear stresses. Conservatively high roughness values should be used for assessing water surface elevations and depths. The lack of vegetation in post construction conditions will result in higher channel velocities and greater potential for erosion. Channels with fully established vegetation will have reduced velocities but higher flow depths.

Table 8-5 provides low and high roughness values that are suitable for initial approximations of hydraulic conditions; however, it is the designer's responsibility to conduct a field reconnaissance of the stream reach being analyzed, characterize roughness conditions along the main channel and overbanks, and select appropriate roughness values. Additional information on estimating roughness values for grass overbanks and cobble channels is discussed below.

**Table 8-5. Recommended roughness values**

<b>Location and Cover</b>	<b>When Assessing Velocity, Froude No., Shear Stress</b>	<b>When Assessing Water Surface Elevation and Water Depth</b>
<u>Main Channel (bankfull channel)</u>		
Sand or clay bed	0.03	0.04
Gravel or cobble bed	0.035	0.07
<u>Vegetated Overbanks</u>		
Turfgrass sod	0.03	0.04
Native grasses	0.032	0.05
Herbaceous wetlands (few or no willows)	0.06	0.12
Willow stands, woody shrubs	0.07	0.16

(Source: Chow 1959, USDA 1954, Barnes 1967, Arcement and Schneider 1989, Jarrett 1985)

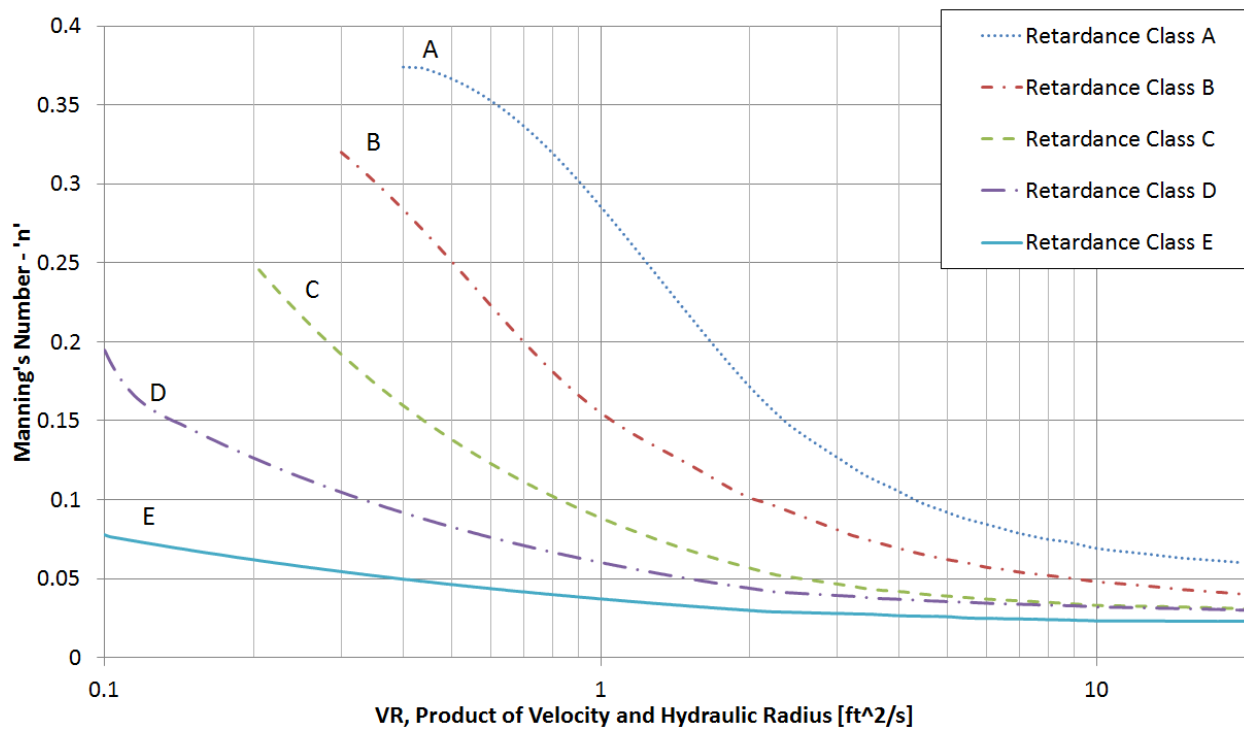
### **Roughness of Grass Overbanks**

A common procedure for determining Manning's  $n$  for vegetated channels is documented in the *Handbook of Channel Design for Soil and Water Conservation* (hereinafter referred to as the NRCS Method). The NRCS Method uses the vegetation properties to establish a degree of retardance. The retardance is based upon the type of plants, the length and condition of the vegetation. Finding a solution for Manning's  $n$  becomes an iterative process using the following channel properties: slope, velocity and hydraulic radius. The documentation for the NRCS method contains a series of curves that provide solutions for Manning's  $n$  values based upon the vegetation retardance. Table 8-6 provides recommended retardance values for channels located along the Colorado Front Range with the given vegetation properties. Refer to the NRCS Method documentation for additional detail and guidance.



**Table 8-6. Recommended retardance curve for vegetation in the Colorado Front Range**

Vegetation Description	Retardance Curve
<b>Fair Stand</b>	
≤8" height	E
>8" height	D
<b>Good Stand</b>	
≤8" height	D
>8" height	C
<b>Dense, Herbaceous Wetland</b>	A



**Figure 8-28. Manning's roughness in vegetated channels**

### Roughness of Cobble (Rock) Channels and Riprap Areas

There are multiple methods available for determining Manning's  $n$  values for cobble/rock lined channels and significant areas of riprap. Two relationships are shown below; it is the responsibility of the designer to evaluate the methods available and determine the approach most appropriate for the specific project conditions.

*Determination of Roughness Coefficients for Streams in Colorado* (Jarrett 1985)

$$n = 0.39S^{0.38}R^{-0.16} \quad \text{Equation 8-8}$$

Where:

$S$  = channel slope (ft/ft)

$R$  = hydraulic radius (ft)

The Manning's roughness coefficient,  $n$ , for a void-filled or soil riprap-lined channel may be estimated using:

$$n = 0.0395D_{50}^{1/6} \quad \text{Equation 8-9}$$

Where:

$D_{50}$  = mean stone size (feet)

This equation is appropriate for computing channel capacity and associated flow depth, but when soil riprap is vegetated, velocity and shear computations should be based on the roughness provided by the vegetation and not the riprap.

This equation does not apply to grouted boulders or to very shallow flow (where hydraulic radius is less than, or equal to 2.0 times the maximum rock size). In those cases the roughness coefficient will be greater than indicated by this equation. The *Hydraulic Structures* chapter covers grouted boulder applications in detail.

### 7.2.4 Design Storms

HEC-RAS refers to design storms as “profiles” and allows a designer to add multiple profiles. Boundary conditions are defined for each profile and options consist of known water surface elevation, critical depth, normal depth or rating curve.

It is recommended that the designer evaluate multiple return periods (profiles) when evaluating a stream reach. These may include the “bankfull” event, 2-year, 5-year, 10-year, 100-year, and perhaps larger events. The 2 through 10-year profiles are important when a shared-use path is planned adjacent to the stream to ensure proper elevation of the path. See the *Stream Access and Recreational Channels* chapter for criteria regarding trails including low-flow crossings.

Evaluation of multiple design storms allows the designer to see variations in flow patterns for different storm events and the resulting velocities, flow depths, etc. In some cases it may be appropriate to modify Manning's  $n$  values based on the flow depth at a specific design storm to more accurately depict the flow conditions.



### 7.2.5 Output Variables

Results from a HEC-RAS steady flow analysis can be viewed in both tabular and graphical format. Tabular output can be generated at an individual cross section or a summary table can be produced that includes multiple cross sections and multiple storm events (profiles). The following is a list of key output variables that the designer should review during analysis (abbreviations used by HEC-RAS are indicated in parentheses).

- Water surface elevation (W.S. Elev)
- Critical water surface elevation (Crit W.S.)
- Froude Number (Froude #)
- Total flowrate within the cross section (Q Total), left overbank (Q Left), channel (Q Channel), and right overbank (Q Right)
- Average velocity in the main channel (Vel Chnl), left overbank (Vel Left), and right overbank (Vel Right)
- Hydraulic depth in the main channel (Hydr Depth C), left overbank (Hydr Depth L), and right overbank (Hydr Depth R)
- Specific Force for the cross section (Specif Force)
- Shear stress in the main channel (Shear Chan), left overbank (Shear LOB), and right overbank (Shear ROB)

The above list is just a small sampling of the variables that HEC-RAS can provide. The designer is responsible for selecting output variables, evaluating all aspects of the channel hydraulics, and determining the acceptable values for the channel parameters based upon the specific project.

Figure 8-29 is an example of tabular output for an individual cross section (referred to as *Detailed Output Table*). Data are provided for the entire cross section and also divided into the bankfull channel and the left/right overbanks, where appropriate.

In addition to the table for an individual cross section, HEC-RAS can also provide a summary table which includes all cross sections and all storm events (profiles) as specified (referred to as *Profile Output Table*). When using the *Profile Output Table* feature, the designer has the ability to create a custom table and specify the output variables that are included in the table, including those listed above. Creating a custom table in HEC-RAS is a useful way to see all of the data summarized at one location. Refer to the *Help* menu, *User's Manual* within HEC-RAS for definitions of the output variables available within HEC-RAS.

Plan: CEM Newlin Gulch DS Stonegate Pkw RS: 9130 Profile: 100-YR

E.G. Elev (ft)	5852.33	Element	Left OB	Channel	Right OB
Vel Head (ft)	0.85	Wt. n-Val.	0.050	0.035	0.040
W.S. Elev (ft)	5851.49	Reach Len. (ft)	34.36	38.65	47.28
Crit W.S. (ft)	5849.94	Flow Area (sq ft)	224.32	72.46	423.45
E.G. Slope (ft/ft)	0.004579	Area (sq ft)	224.32	72.46	423.45
Q Total (cfs)	4720.00	Flow (cfs)	906.11	761.18	3052.70
Top Width (ft)	174.00	Top Width (ft)	78.16	9.87	85.96
Vel Total (ft/s)	6.55	Avg. Vel. (ft/s)	4.04	10.51	7.21
Max Chl Dpth (ft)	7.71	Hydr. Depth (ft)	2.87	7.34	4.93
Conv. Total (cfs)	69753.1	Conv. (cfs)	13390.7	11248.9	45113.4
Length Wtd. (ft)	41.12	Wetted Per. (ft)	78.79	10.36	87.19
Min Ch El (ft)	5843.77	Shear (lb/sq ft)	0.81	2.00	1.39
Alpha	1.27	Stream Power (lb/ft s)	237.90	0.00	0.00
Frctn Loss (ft)	0.19	Cum Volume (acre-ft)	1.80	9.74	3.64
C & E Loss (ft)	0.04	Cum SA (acres)	0.66	1.49	1.29

**Figure 8-29. Example HEC-RAS tabular output for individual cross section**

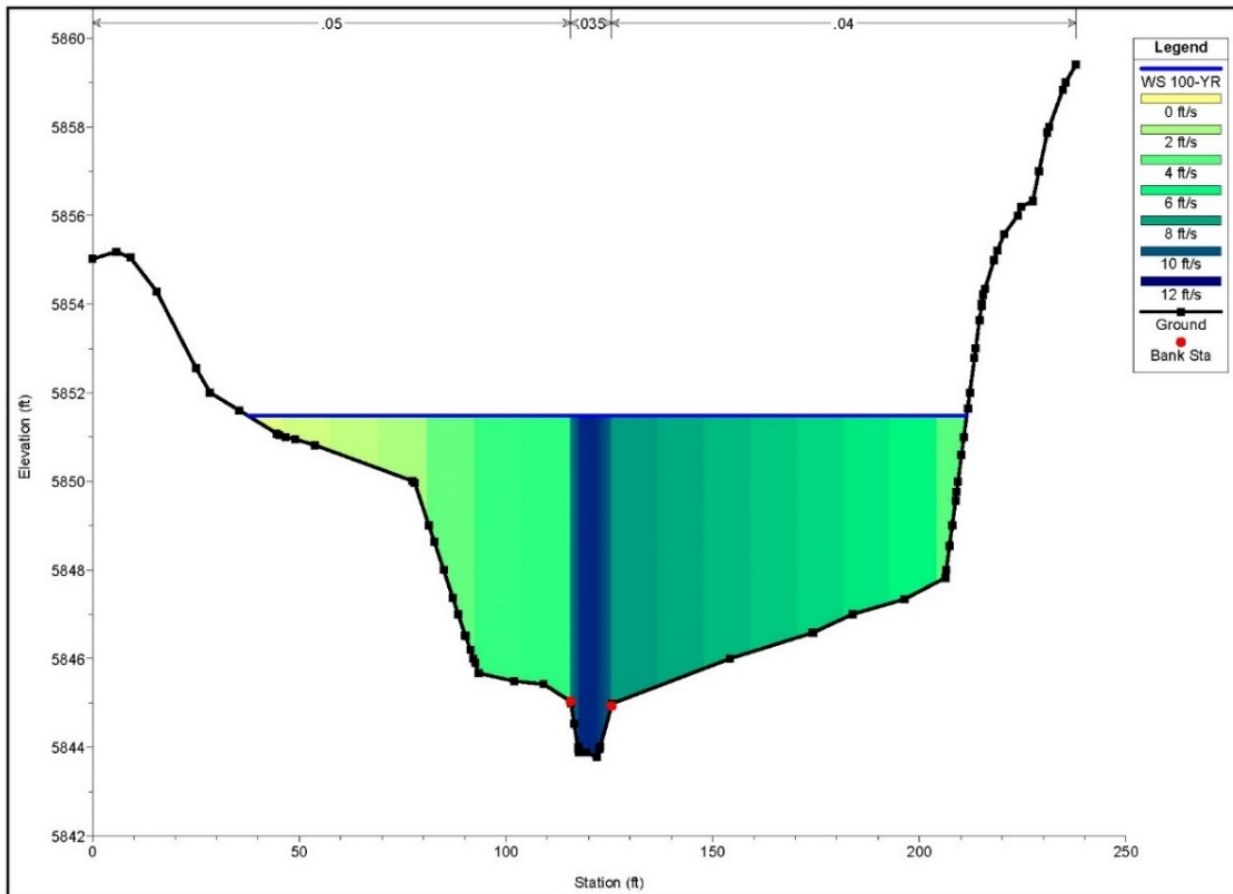
When performing a steady flow analysis with HEC-RAS, the user has the option to evaluate flow distribution at one or more cross section. The user can specify the interval of the distribution (e.g., every 10 feet along cross section or at other intervals) and then use the results to evaluate hydraulic parameters at specific locations on a cross section. This may be beneficial when determining erosion protection at the toe of the bankfull channel versus a location in the overbank. The designer can review the flow velocity at that specific location in the cross section and determine the appropriate erosion protection. Figure 8-30 is an example table summarizing the flow distribution at an individual cross section.

Plan: CEM Newlin Gulch DS Stonegate Pkw RS: 9130 Profile: 100-YR

	Pos	Left Sta	Right Sta	Flow	Area	W.P.	Percent	Hydr	Velocity	Shear	Power
		(ft)	(ft)	(cfs)	(sq ft)	(ft)	Conv	Depth(ft)	(ft/s)	(lb/sq ft)	(lb/ft s)
1	LOB	34.69	46.25	1.29	2.20	8.80	0.03	0.25	0.58	0.07	0.04
2	LOB	46.25	57.82	7.79	7.24	11.57	0.17	0.63	1.08	0.18	0.19
3	LOB	57.82	69.38	17.12	11.62	11.57	0.36	1.00	1.47	0.29	0.42
4	LOB	69.38	80.94	33.43	17.43	11.69	0.71	1.51	1.92	0.43	0.82
5	LOB	80.94	92.50	166.99	46.24	12.00	3.54	4.00	3.61	1.10	3.98
6	LOB	92.50	104.07	327.60	68.32	11.59	6.94	5.91	4.80	1.68	8.08
7	LOB	104.07	115.63	351.89	71.27	11.57	7.46	6.16	4.94	1.76	8.69
8	Chan	115.63	116.62	61.42	6.67	1.16	1.30	6.76	9.20	1.65	15.19
9	Chan	116.62	117.60	71.73	7.22	1.12	1.52	7.32	9.93	1.85	18.38
10	Chan	117.60	118.59	82.53	7.50	0.99	1.75	7.59	11.01	2.16	23.78
11	Chan	118.59	119.58	82.82	7.50	0.99	1.75	7.60	11.05	2.17	23.98
12	Chan	119.58	120.57	83.36	7.53	0.99	1.77	7.63	11.07	2.18	24.12
13	Chan	120.57	121.55	84.19	7.57	0.99	1.78	7.67	11.12	2.19	24.36
14	Chan	121.55	122.54	82.76	7.56	1.01	1.75	7.66	10.94	2.14	23.42
15	Chan	122.54	123.53	76.54	7.30	1.04	1.62	7.39	10.49	2.01	21.06
16	Chan	123.53	124.51	70.68	6.97	1.04	1.50	7.06	10.14	1.91	19.38
17	Chan	124.51	125.50	65.15	6.64	1.04	1.38	6.72	9.82	1.82	17.86
18	ROB	125.50	136.74	588.30	70.91	11.26	12.46	6.31	8.30	1.80	14.94
19	ROB	136.74	147.98	527.59	66.40	11.25	11.18	5.91	7.95	1.69	13.41
20	ROB	147.98	159.22	470.34	61.97	11.25	9.96	5.51	7.59	1.58	11.96
21	ROB	159.22	170.46	423.26	58.17	11.24	8.97	5.18	7.28	1.48	10.76
22	ROB	170.46	181.70	374.81	54.09	11.25	7.94	4.81	6.93	1.37	9.52
23	ROB	181.70	192.94	322.13	49.38	11.25	6.82	4.39	6.52	1.26	8.19
24	ROB	192.94	204.18	278.65	45.28	11.25	5.90	4.03	6.15	1.15	7.08
25	ROB	204.18	215.42	67.63	17.26	8.45	1.43	2.37	3.92	0.58	2.29

**Figure 8-30. Example HEC-RAS tabular output for flow distribution at individual cross section**

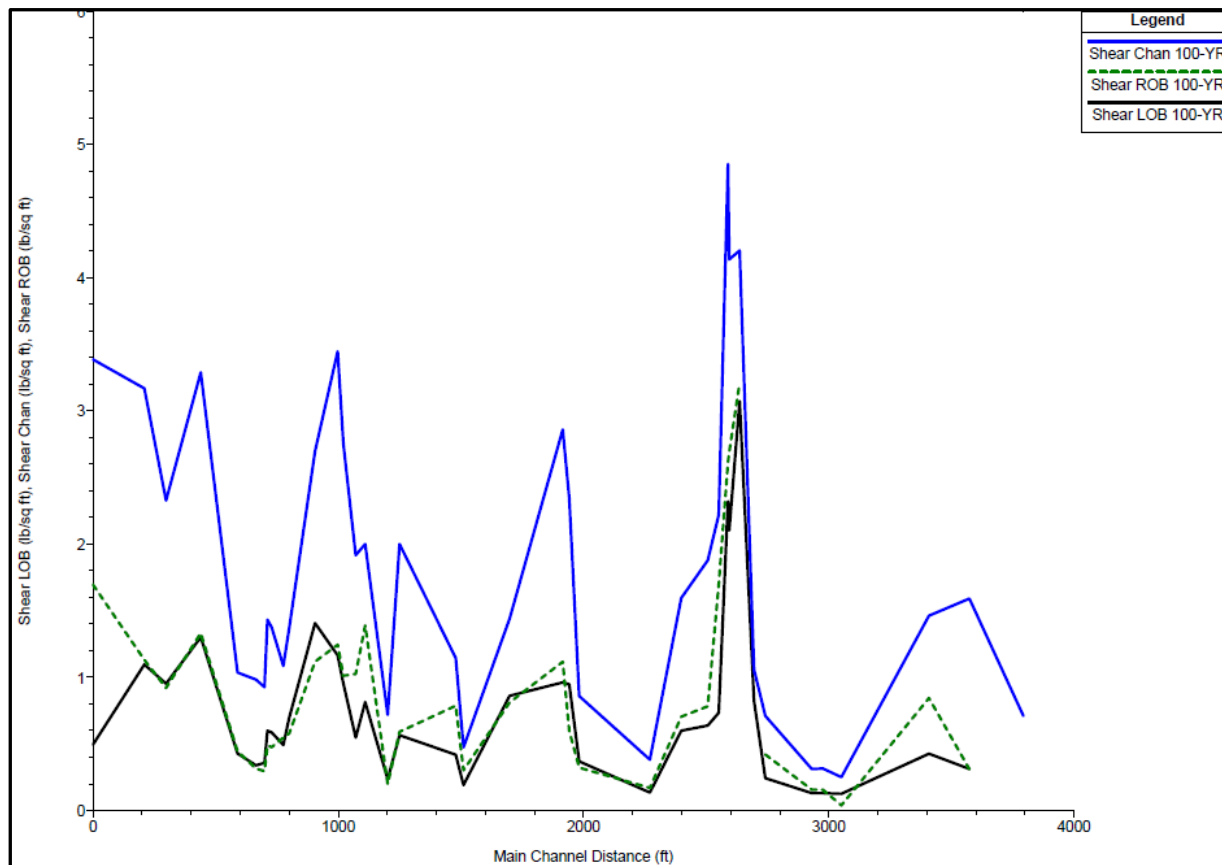
Graphical output can be in the form of a cross section, water surface profile, or rating curve. The user has the ability to specify the variables that are included on the graphical output. Figure 8-31 is an example plot of a cross section showing a velocity distribution. The velocity distribution is generated by turning on the flow distribution feature of HEC-RAS, as discussed earlier in this section.



**Figure 8-31. Example HEC-RAS cross section with velocity distribution**

Using the *General Profile Plot* feature of HEC-RAS, multiple variables can be viewed in a profile format along the length of a stream. An example plot using this feature is shown in Figure 8-32 below. Figure 8-32 is a plot of shear stress for a channel reach which separates the output into the main channel, left overbank and right overbank.

The example plot indicates that overbank shear stress is highest near stations 200, 900, 1800 and extremely high near station 2600. The information shown in the figure would lead the designer to assess the ability of the overbank vegetation to resist the imposed shear in these stations. If the shear stress is greater than the estimated ability of the overbank to resist, the designer should assess the associated risks and consider whether steps should be taken to reinforce the overbank at these locations.



**Figure 8-32. Example HEC-RAS general profile plot of shear stress**

### 7.3 Evaluation of Erosion at Channel Bends

Special erosion control measures are often needed at bends. Riprap sizing should be based on locally higher velocities at the outside of a bend. An estimate of velocity along the outside of the bend can be made using the following equation.

$$V_a = \left(-0.147 \frac{r_c}{T} + 2.176\right) V \quad \text{Equation 8-10}$$

Where:

$V_a$  = adjusted channel velocity for riprap sizing along the outside of channel bends (ft/sec)

$V$  = mean channel velocity for the peak flow of the major design flow (ft/sec)

$r_c$  = channel centerline radius (ft)

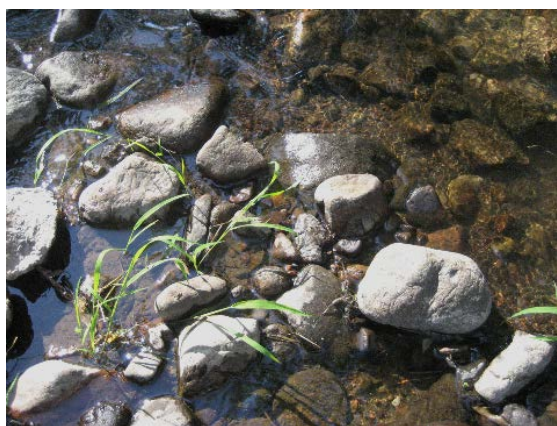
$T$  = Top width of water during the major design flow (ft)

## 8.0 Rock and Boulders

In conditions where rock protection is required, it is recommended that soil riprap, void-filled riprap, or boulders be used. For small installations, and where vegetation is not anticipated, riprap over bedding material may also be used.

Soil riprap refers to riprap that has all void spaces filled with topsoil with the intention of supporting vegetative growth. Soil riprap is intended for use in applications where vegetative cover can be established and where the shear stress, imposed by frequently occurring flows, is less than the resistive strength of the vegetation and soil. The riprap layer is designed to remain stable and provide protection during the extreme events.

Void-filled riprap is designed to emulate natural rock riffle material found in steep gradient streams. It contains a well-graded mix of cobbles, gravels, sands, and soil that fills all voids and acts as an internal filter, therefore a separate bedding layer between subgrade and rock is not required. In applications where it is difficult to establish vegetation, void-filled riprap is better able to resist the direct, prolonged impingement of water on the riprap installation compared to soil riprap. However, void-filled riprap is more difficult to properly mix and install compared to soil riprap (see inset). UDFCD recommends review of the technical paper titled *demonstration Project Illustrating Void-Filled Riprap Applications in Stream Restoration* (Wulliman and Johns 2011). This paper provides background on the derivation of void-filled riprap and its applications in stream restoration and is available the UDFCD website.



**Photograph 8-18.** Void-filled riprap is designed to emulate natural rock riffle material; it consists of a mix of rock, gravels, sands, and soil that is densely-packed and able to support riparian vegetation.

Table 8-7 provides a comparison between soil riprap and void-filled riprap.

### Specifying Void-Filled Riprap

Void-filled riprap is far more challenging to properly mix and install than soil riprap and requires close designer involvement during construction to ensure the mixture is properly mixed and placed. When it is not properly mixed and/or placed, flows will wash away the void material and eventually start to also move the larger rock. Before specifying void-filled riprap, ensure that adequate construction observation time by a qualified individual is available as part of the construction budget. For more information on mixing and placing void-filled riprap see the technical paper titled *Demonstration Project Illustrating Void-Filled Riprap Applications in Stream Restoration* (Wulliman and Johns 2011) and the UDFCD construction specifications, both available at [www.UDFCD.org](http://www.UDFCD.org).

**Table 8-7. Comparison of void-filled riprap and soil riprap**

	<b>Void-Filled Riprap</b>	<b>Soil Riprap</b>
<b>Advantages</b>	<ul style="list-style-type: none"> <li>▪ Better emulates natural streambed material.</li> <li>▪ Provides better stability and armoring in riverine environments.</li> <li>▪ Creates a dense, interlocking mass and functions as an effective internal filter, keeping water flows on the surface and reducing the likelihood that flows will displace the material and expose a weak spot in the subgrade.</li> <li>▪ Provides a growing medium that supports riparian vegetation.</li> </ul>	<ul style="list-style-type: none"> <li>▪ Requires mixing of only two different materials and, therefore requires less effort to order, stockpile, and mix materials.</li> <li>▪ Requires less expertise and oversight during mixing and placing.</li> <li>▪ Organic material within the growing medium supports riparian vegetation.</li> </ul>
<b>Disadvantages</b>	<ul style="list-style-type: none"> <li>▪ Requires mixing up to five or six different aggregates in the proper proportions. This requires additional effort in ordering, stockpiling, mixing, and placing materials compared to soil riprap.</li> <li>▪ Difficult to inspect after installation because small void-material can cover larger riprap. Need to inspect <u>during</u> placement.</li> <li>▪ Requires construction observation for submittal and sample material review, adjustments to the mix proportions to compensate for varying material gradation, approval of test fields mixing operations, and observation of placement and compaction.</li> <li>▪ Costs more than soil riprap.</li> <li>▪ If not well mixed, pockets of small void material, especially near surface can wash out and unravel void-filled riprap installation. Need to continually monitor and make sure larger riprap is not displaced and located at surface to provide sufficient D<sub>50</sub>.</li> </ul>	<ul style="list-style-type: none"> <li>▪ Does not provide the same level of stability and armoring in areas of direct, continuous flow impingement.</li> </ul>

## 8.1 Riprap Sizing

Procedures for sizing rock to be used in soil riprap, void-filled riprap, and riprap over bedding are the same.

### 8.1.1 Mild Slope Conditions

When subcritical flow conditions occur and/or slopes are mild (less than 2 percent), UDFCD recommends the following equation (Hughes, et al, 1983):

$$d_{50} \geq \left[ \frac{VS^{0.17}}{4.5(G_s - 1)^{0.66}} \right]^2 \quad \text{Equation 8-11}$$

Where:

V = mean channel velocity (ft/sec)

S = longitudinal channel slope (ft/ft)

$d_{50}$  = mean rock size (ft)

$G_s$  = specific gravity of stone (minimum = 2.50, typically 2.5 to 2.7), Note: In this equation ( $G_s - 1$ ) considers the buoyancy of the water, in that the specific gravity of water is subtracted from the specific gravity of the rock.

Note that Equation 8-11 is applicable for sizing riprap for channel lining with a longitudinal slope of no more than 2%. This equation is not intended for use in sizing riprap for steep slopes (typically in excess of 2 percent), rundowns, or protection downstream of culverts. Information on rundowns is provided in Section 7.0 of the *Hydraulic Structures* chapter of the USDCM, and protection downstream of culverts is discussed in the *Culverts and Bridges* chapter. For channel slopes greater than 2% use one of the methods presented in 8.1.2.

Rock size does not need to be increased for steeper channel side slopes, provided the side slopes are no steeper than 2.5H:1V (UDFCD 1982). Channel side slopes steeper than 2.5H:1V are not recommended because of stability, safety, and maintenance considerations. See Figure 8-34 for riprap placement specifications. At the upstream and downstream termination of a riprap lining, the thickness should be increased 50% for at least 3 feet to prevent undercutting.

### 8.1.2 Steep Slope Conditions

Steep slope rock sizing equations are used for applications where the slope is greater than 2 percent and/or flows are in the supercritical flow regime. The following rock sizing equations may be referred to for riprap design analysis on steep slopes:

- CSU Equation, *Development of Riprap Design Criteria by Riprap Testing in Flumes: Phase II* (prepared by S.R. Abt, et al, Colorado State University, 1988). This method was developed for steep slopes from 2 to 20 percent.
- USDA- Agricultural Research Service Equations, *Design of Rock Chutes* (by K.M. Robinson, et al, USDA- ARS, 1998 Transactions of ASAE) and *An Excel Program to Design Rock Chutes for Grade*



*Stabilization*, (K.M. Robinson, et al, USDA- ARS, 2000 ASAE Meeting Presentation). This method is based on laboratory data for slopes from 2 to 40 percent.

- USACE Steep Slope Riprap Equation, *Hydraulic Design of Flood Control Channels, EM1110-2-1601*, (June 1994). This method is applicable for slopes from 2 to 20 percent.

All three of the steep slope methods are based on two key parameters: unit discharge and slope. Flow concentration is one of the main problems that can develop along steep riprap slopes; both CSU and USACE methods recommend that the design unit discharge be increased by a flow concentration factor. When using the CSU equation or the USDA method, increase the largest rock size by approximately 30% when specifying standard UDFCD riprap gradations. This increase accounts for the fact that the steep slope equations were developed using poorly graded rock (uniform in size) unlike the well-graded gradations in UDFCD specifications. Additionally, for the reasons described in the following section, it is typical to also apply a safety factor of 1.5 or more times the calculated D50 riprap size when using any of these steep slope riprap sizing methods. When using the CSU equation or the USDA method apply the safety factor after increasing the largest rock size by 30%.

### 8.1.3 Design Safety Factor

Whether in mild slope or steep slope conditions, consider a safety factor when specifying the sides of riprap. Sizing methods presented in this manual were developed from controlled laboratory conditions. Field installation of rock is much less precise compared to laboratory conditions. It is difficult to grade riprap flat across a channel bottom or in a manner that provides a uniform slope. Sometimes the riprap delivered from local quarries is slightly smaller than specified. Flow conditions in streams can be affected by a variety of elements including debris, sedimentation, vegetation, etc. and can result in flow concentrations. It is important to include a safety factor when using these equations because the variability associated with conditions in the field cannot be quantified.

## 8.2 Boulder and Riprap Specifications

Specific material and installation specifications for riprap and boulders can be found in UDFCD's Construction Specifications, available at [www.udfcd.org](http://www.udfcd.org).

### 8.2.1 Boulders

Boulders may be placed and grouted or placed without grout. When not grouted, boulders require careful design to provide a firm foundation and stable configuration as well as properly graded backfill material sized to prevent migration of fine subgrade material through voids in the boulders. All stacked boulders require consideration of stability and any stacked boulder configuration over six feet in height requires a structural analysis to confirm proper design. Additionally, some municipalities require structural analysis and a building permit for walls greater than four feet.

Grouted boulders should follow the general guidelines described as part of the sections on grouted boulder grade control structures in the *Hydraulic Structures* Chapter and in the UDFCD Construction Specifications. See Figure 8-36 for typical construction of a grouted boulder bank protection.

### 8.2.2 Soil Riprap

Soil riprap is intended for use in applications where vegetative cover can be established in the riprap. When installed outside of the low-flow channel, UDFCD frequently specifies 4 to 6 inches of topsoil on top of soil riprap to help establish vegetation. Soil used in the voids and placed on top of the soil riprap

should meet the description for viable topsoil composition for Colorado native plant establishment and upland areas as defined in the *Revegetation* chapter. See Figure 8-34 for gradation and placement of both riprap and soil riprap. Also see Figure 13 –19 in the *Revegetation* chapter for a fabric staking detail that can be used where fabric is specified over soil riprap. The combination of straw and coir mat is frequently used to help retain soil and seed. This is especially useful when topsoil is placed on top of soil riprap and then seeded. Specifications for mixing and installing soil riprap are further addressed in the UDFCD Construction Specifications.

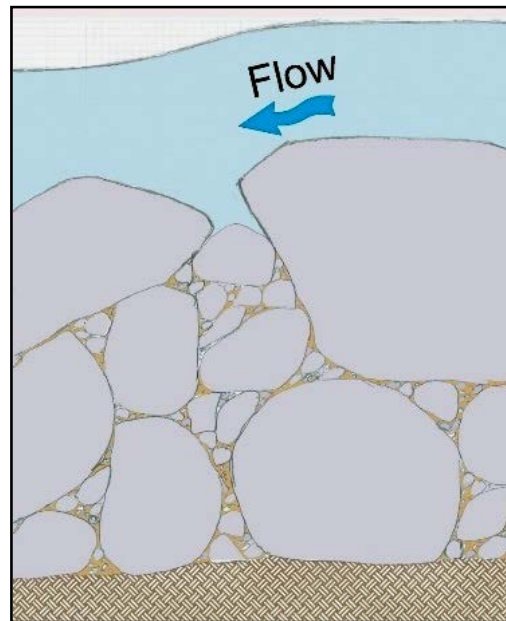
### 8.2.3 Void-Filled Riprap

Void-filled riprap contains a well-graded mix of cobbles, gravels, sands, and soil that fills all voids and acts as an internal filter.

In addition to specifying the  $D_{50}$  rock size, individual material components that will make up the mix needed to be specified. The gradation of each material component should be specified by identifying a variety of particle sizes (from large to small) and the range of allowable “passing” percentages for each particle size. See Figure 8-35 for typical mixes of various sized rock, however, the designer should specify any mix adjustments based on the requirements of a particular project.



**Photograph 8-18.** Void-filled riprap is designed to emulate natural riffles, consisting of a mix of rock, gravels and sands that is densely-packed and able to support riparian vegetation.



**Figure 8-33. Small rock of void-filled riprap becomes “wedged in” under larger rock (Source: Muller Engineering Company)**



**Photograph 8-19.** Seven-inch minus crushed surge is a key ingredient to fill gaps between riprap.



**Photograph 8-20.** Four-inch minus pit run surge is also an important ingredient to fill gaps between riprap.



**Photograph 8-21.** Void-filled riprap after placement and compaction.

Sufficient construction oversight by an engineer and/or a construction inspector knowledgeable in mixing and placing void-fill riprap is essential. This includes reviewing rock material submittals, field observation during initial mixing, and observation during placement of void-filled riprap. These construction services are summarized below; detailed specifications for mixing and placing void-filled riprap are provided in the UDFCD Construction Specifications available at [www.udfcd.org](http://www.udfcd.org).

1. **Material Submittals.** Laboratory test certificates, gradations, and suppliers for all materials included in the riffle rock mix should be submitted for review. If there is difficulty finding material that meets the specified gradation for a particular component, this can often be resolved by selecting a different supplier for that component.
2. **Mixing Void-Filled Riprap.** Individual void-filled riprap materials are typically delivered and unloaded onsite in separate stockpiles. Mixing is typically accomplished using a front end loader to add the proper “loader bucket” proportions of each material into one combined stockpile. Once all the materials have been added, the pile is mixed thoroughly to blend the materials together using the loader or large track hoe excavator. The goal is to fill the voids of the base riprap material **without displacing the riprap**. The interlocking nature of riprap in the mixed material needs to remain essentially the same as if the riprap was placed without void-fill material.

The specified mix proportions are noted as approximate because the two surge materials vary somewhat between different suppliers and variations in gravel pits. Therefore, it is important that the design engineer is onsite during the first mixing operation to make slight adjustments to the proportions if necessary.

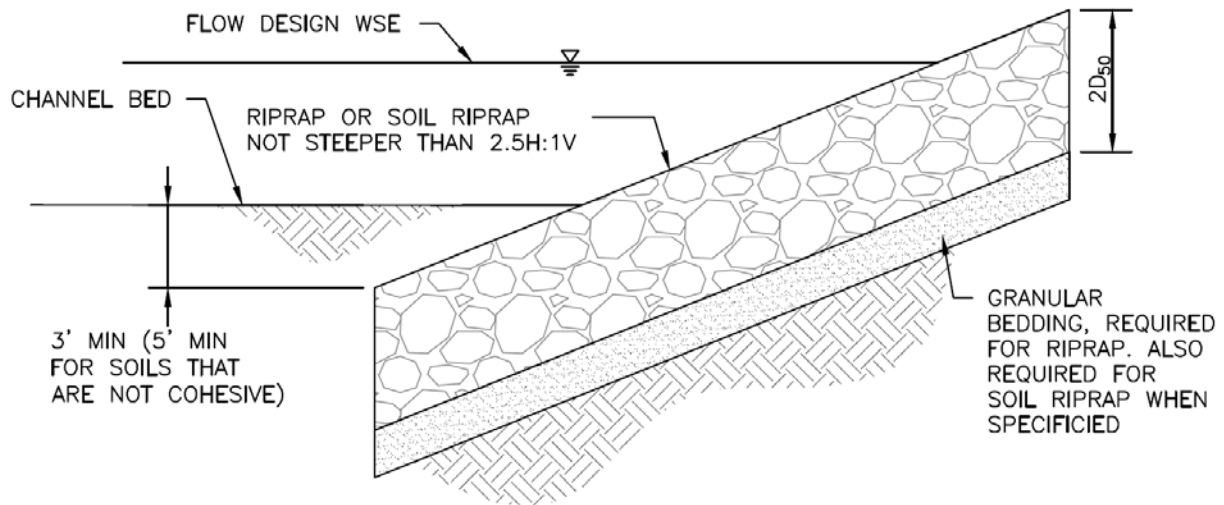
3. **Placing Void-Filled Riprap.** Void-filled riprap can be challenging to place as it has a tendency to segregate. Finer sands and gravels will separate from the larger riprap. Contractors must take care to minimize segregation when hauling the mixed material from the stockpile to the installation location.

Loose material must be placed in a single lift of sufficient height such that final grade will be achieved upon compaction. In most cases, some additional mixing with a track excavator is needed after the initial placement to make sure that void-filled riprap is thoroughly mixed and that there is no segregation or areas where the void-filled riprap consists primarily of the smaller void-fill materials. A pocket of fine void-fill materials near the surface, without sufficient larger riprap, can get washed out and create flow concentrations that could unravel the void-filled riprap installation. **The goal is to fill the riprap voids without displacing riprap.**

The last step is to compact the loosely placed void-filled riprap material by driving over it with a heavy duty loader or similar equipment. Water should be added, if necessary, so that the moisture content of the mixture is at optimum conditions during the compaction process.

It is important that the finished top elevation of the void-filled riprap layer closely matches design grades to within a tolerance of 0.10 feet. Having a tight elevation tolerance helps to minimize development of flow concentrations. Finally, if for some reason the compacted material ends up below final grade, it is not acceptable to allow placement of only the smaller void-fill material or additional top dressing cobbles to achieve final grade. In such cases it is necessary to add more standard sized void-filled riprap and remix the entire thickness of rock to achieve the design section.

To ensure proper mixing and placement of void-filled riprap, UDFCD recommends construction of a test section. Requiring the approval of a test section helps to ensure that the contractor understands construction requirements at the start of a project and can make adjustments as necessary during construction.



RIPRAP DESIGNATION	% SMALLER THAN GIVEN SIZE BY WEIGHT	INTERMEDIATE ROCK DIMENSION (INCHES)	D <sub>50</sub> * (INCHES)
TYPE VL	70 - 100	12	6
	50 - 70	9	
	35 - 50	6	
	2 - 10	2	
TYPE L	70 - 100	15	9
	50 - 70	12	
	35 - 50	9	
	2 - 10	3	
TYPE M	70 - 100	21	12
	50 - 70	18	
	35 - 50	12	
	2 - 10	4	
TYPE H	70 - 100	30	18
	50 - 70	24	
	35 - 50	18	
	2 - 10	6	

\*D<sub>50</sub> = MEAN ROCK SIZE

Figure 8-34. Riprap and soil riprap placement and gradation (part 1 of 3)

SOIL RIPRAP NOTES:

1. ELEVATION TOLERANCES FOR THE SOIL RIPRAP SHALL BE 0.10 FEET. THICKNESS OF SOIL RIPRAP SHALL BE NO LESS THAN THICKNESS SHOWN AND NO MORE THAN 2-INCHES GREATER THAN THE THICKNESS SHOWN.
2. WHERE "SOIL RIPRAP" IS DESIGNATED ON THE CONTRACT DRAWINGS, RIPRAP VOIDS ARE TO BE FILLED WITH NATIVE SOIL. THE RIPRAP SHALL BE PRE-MIXED WITH THE NATIVE SOIL AT THE FOLLOWING PROPORTIONS BY VOLUME: 65PERCENT RIPRAP AND 35 PERCENT SOIL. THE SOIL USED FOR MIXING SHALL BE NATIVE TOPSOIL AND SHALL HAVE A MINIMUM FINES CONTENT OF 15 PERCENT. THE SOIL RIPRAP SHALL BE INSTALLED IN A MANNER THAT RESULTS IN A DENSE, INTERLOCKED LAYER OF RIPRAP WITH RIPRAP VOIDS FILLED COMPLETELY WITH SOIL. SEGREGATION OF MATERIALS SHALL BE AVOIDED AND IN NO CASE SHALL THE COMBINED MATERIAL CONSIST PRIMARILY OF SOIL; THE DENSITY AND INTERLOCKING NATURE OF RIPRAP IN THE MIXED MATERIAL SHALL ESSENTIALLY BE THE SAME AS IF THE RIPRAP WAS PLACED WITHOUT SOIL.
3. WHERE SPECIFIED (TYPICALLY AS "BURIED SOIL RIPRAP"), A SURFACE LAYER OF TOPSOIL SHALL BE PLACED OVER THE SOIL RIPRAP ACCORDING TO THE THICKNESS SPECIFIED ON THE CONTRACT DRAWINGS. THE TOPSOIL SURFACE LAYER SHALL BE COMPACTED TO APPROXIMATELY 85% OF MAXIMUM DENSITY AND WITHIN TWO PERCENTAGE POINTS OF OPTIMUM MOISTURE IN ACCORDANCE WITH ASTM D698. TOPSOIL SHALL BE ADDED TO ANY AREAS THAT SETTLE.
4. ALL SOIL RIPRAP THAT IS BURIED WITH TOPSOIL SHALL BE REVIEWED AND APPROVED BY THE ENGINEER PRIOR TO ANY TOPSOIL PLACEMENT.

GRADATION FOR GRANULAR BEDDING		
U.S. STANDARD SIEVE SIZE	PERCENT PASSING BY WEIGHT	
	TYPE I CDOT SECT. 703.01	TYPE II CDOT SECT. 703.09 CLASS A
3 INCHES	—	90 — 100
1½ INCHES	—	—
¾ INCHES	—	20 — 90
⅜ INCHES	100	—
#4	95 — 100	0 — 20
#16	45 — 80	—
#50	10 — 30	—
#100	2 — 10	—
#200	0 — 2	0 — 3

RIPRAP BEDDING

**Figure 8-34. Riprap and soil riprap placement and gradation (part 2 of 3)**

THICKNESS REQUIREMENTS FOR GRANULAR BEDDING			
RIPRAP DESIGNATION	MINIMUM BEDDING THICKNESS (INCHES)		
	FINE-GRAINED SOILS <sup>1</sup>		COARSE-GRAINED SOILS <sup>2</sup>
	TYPE I (LOWER LAYER)	TYPE II (UPPER LAYER)	TYPE II
VL (D <sub>50</sub> = 6 IN)	4	4	6
L (D <sub>50</sub> = 9 IN)	4	4	6
M (D <sub>50</sub> = 12 IN)	4	4	6
H (D <sub>50</sub> = 18 IN)	4	6	8
VH (D <sub>50</sub> = 24 IN)	4	6	8

## NOTES:

1. MAY SUBSTITUTE ONE 12-INCH LAYER OF TYPE II BEDDING. THE SUBSTITUTION OF ONE LAYER OF TYPE II BEDDING SHALL NOT BE PERMITTED AT DROP STRUCTURES. THE USE OF A COMBINATION OF FILTER FABRIC AND TYPE II BEDDING AT DROP STRUCTURES IS ACCEPTABLE.
2. FIFTY PERCENT OR MORE BY WEIGHT RETAINED ON THE #40 SIEVE.

**Figure 8-34. Riprap and soil riprap placement and gradation (part 3 of 3)**



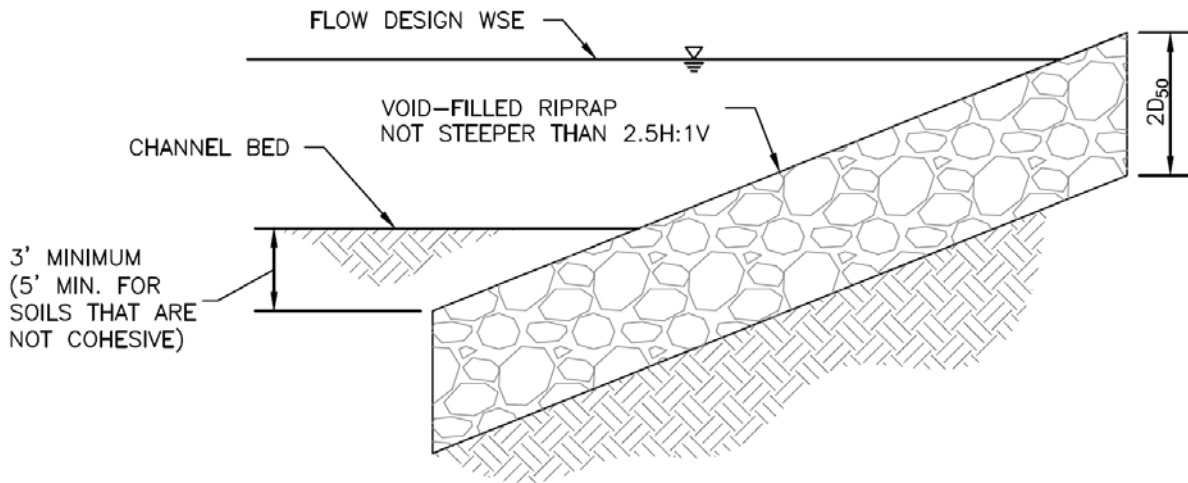


TABLE 1. MIX REQUIREMENTS FOR TYPE VL AND L VOID-FILLED RIPRAP (D<sub>50</sub> = 6 TO 9 INCH)

APPROPRIATE PROPORTIONS (BY VOLUME)	MATERIAL TYPE	MATERIAL DESCRIPTION
6 PARTS	RIPRAP	D <sub>50</sub> = 6 INCH (TYPE VL) OR D <sub>50</sub> = 9 INCH (TYPE L), SEE TABLE 3
1 PART	VOID-FILL MATERIAL	VTC (VEHICLE TRACKING CONTROL) ROCK (CRUSHED ROCK WITH 100% PASSING 4-INCH SIEVE, 50-70% PASSING 3-INCH SIEVE, 0-10% PASSING 2-INCH SIEVE)
1 PART	VOID-FILL MATERIAL	4-INCH MINUS PIT RUN SURGE (ROUND RIVER ROCK AND SAND, WELL GRADED, 90-100% PASSING 4-INCH SIEVE, 70-80% PASSING 1½-INCH SIEVE, 40-60% PASSING ¾-INCH SIEVE, 10-30% PASSING #16 SIEVE)
1 PART	VOID-FILL MATERIAL	TYPE II BEDDING (CRUSHED ROCK WITH 100% PASSING 3-INCH SIEVE, 20-90% PASSING ¾-INCH SIEVE, 0-20% PASSING #4 SIEVE, 0-3% PASSING #200 SIEVE)
½ TO 1 PART	VOID-FILL MATERIAL	NATIVE TOPSOIL

**VOID-FILLED RIPRAP PLACEMENT AND GRADATION**

**Figure 8-35. Void-filled riprap placement and gradation (part 1 of 3)**



APPROPRIATE PROPORTIONS (BY VOLUME)	MATERIAL TYPE	MATERIAL DESCRIPTION
6 PARTS	RIPRAP	$D_{50} = 12$ -INCH (TYPE M) OR $D_{50} = 18$ -INCH (TYPE H), SEE TABLE 3
2 PART	VOID-FILL MATERIAL	7-INCH MINUS CRUSHED ROCK SURGE (100% PASSING 7-INCH SIEVE, 80-100% PASSING 6-INCH SIEVE, 35-50% PASSING 3-INCH SIEVE, 10-20% PASSING 1½-INCH SIEVE)
1 PART	VOID-FILL MATERIAL	VTC (VEHICLE TRACKING CONTROL) ROCK (CRUSHED ROCK WITH 100% PASSING 4-INCH SIEVE, 50-70% PASSING 3-INCH SIEVE, 0-10% PASSING 2-INCH SIEVE)
1 PART	VOID-FILL MATERIAL	4-INCH MINUS PIT RUN SURGE (ROUND RIVER ROCK AND SAND, WELL GRADED, 90-100% PASSING 4-INCH SIEVE, 70-80% PASSING 1½-INCH SIEVE, 40-60% PASSING ¾-INCH SIEVE, 10-30% PASSING #16 SIEVE)
1 PART	VOID-FILL MATERIAL	TYPE II BEDDING (CRUSHED ROCK WITH 100% PASSING 3-INCH SIEVE, 20-90% PASSING ¾-INCH SIEVE, 0-20% PASSING #4 SIEVE, 0-3% PASSING #200 SIEVE)
½ TO 1 PART	VOID-FILL MATERIAL	NATIVE TOPSOIL

RIPRAP DESIGNATION	% SMALLER THAN GIVEN SIZE BY WEIGHT	INTERMEDIATE ROCK DIMENSION (INCHES)	$D_{50}^*$ (INCHES)
TYPE VL	70 - 100	12	6
	50 - 70	9	
	35 - 50	6	
	2 - 10	2	
TYPE L	70 - 100	15	9
	50 - 70	12	
	35 - 50	9	
	2 - 10	3	
TYPE M	70 - 100	21	12
	50 - 70	18	
	35 - 50	12	
	2 - 10	4	
TYPE H	70 - 100	30	18
	50 - 70	24	
	35 - 50	18	
	2 - 10	6	

\* $D_{50}$  = MEAN ROCK SIZE

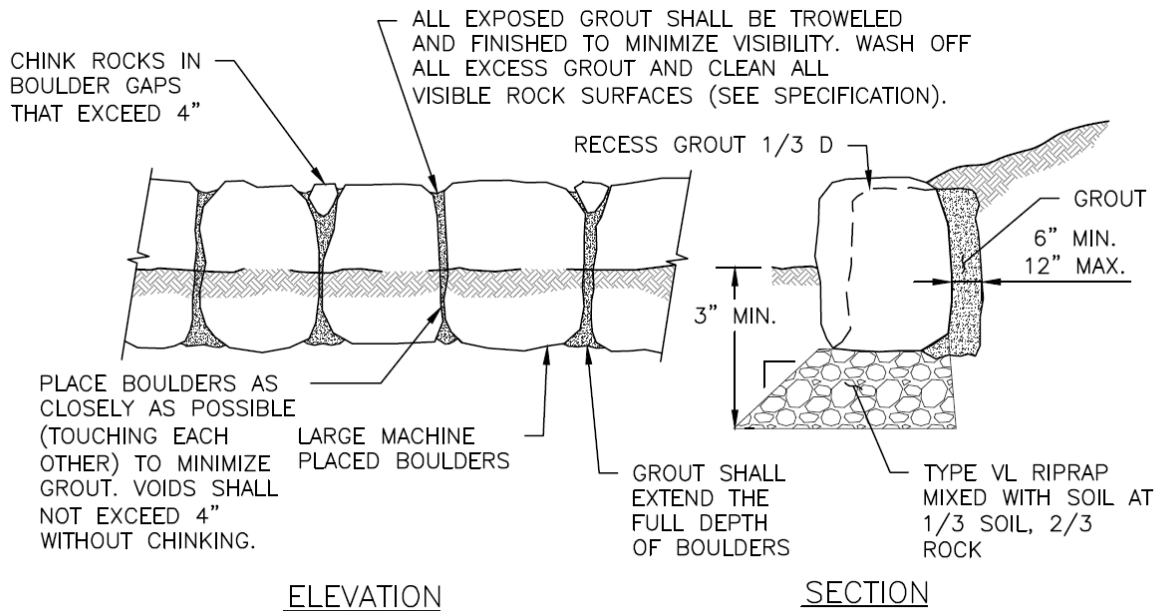
NOTE: MIX ON SITE AND PRIOR TO PLACEMENT

**Figure 8-35. Void-filled riprap placement and gradation (part 2 of 3)**

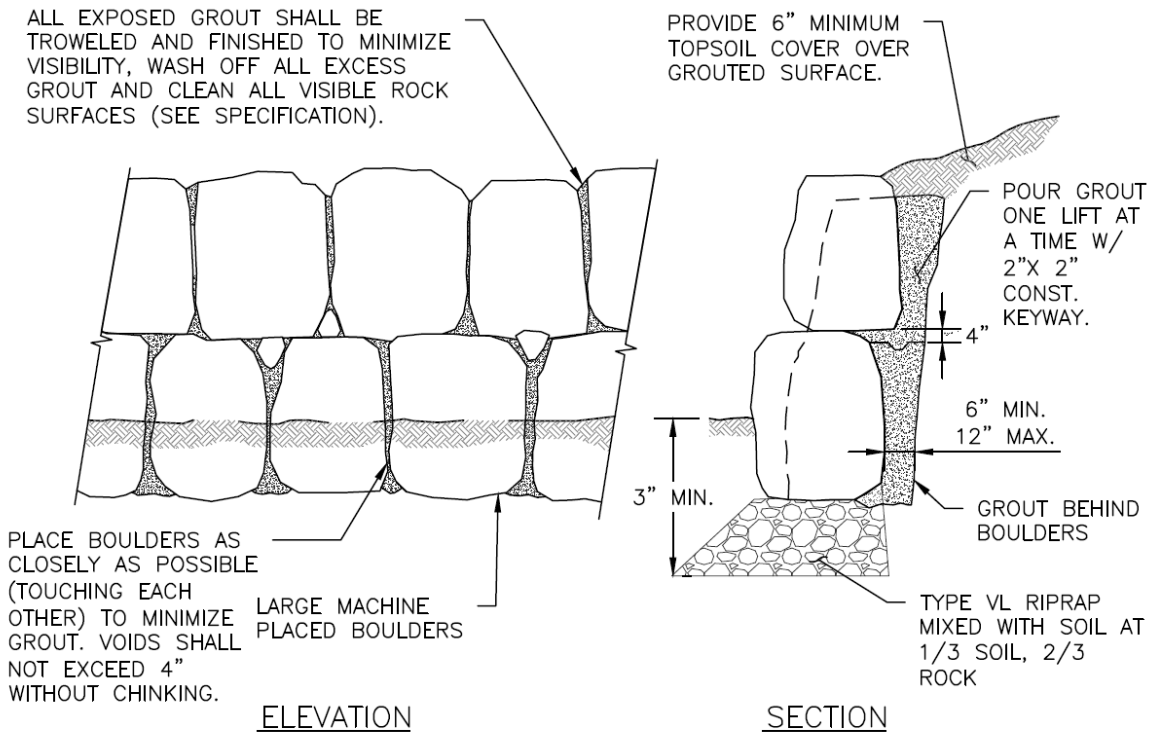
## VOID-FILLED RIPRAP PLACEMENT AND GRADATION NOTES:

1. WHERE "VOID-FILLED RIPRAP" IS DESIGNATED ON THE CONTRACT DRAWINGS, RIPRAP SHALL BE MIXED WITH THE MATERIALS AND ASSOCIATED PROPORTIONS LISTED IN TABLE 1 OR TABLE 2 TO FILL THE VOIDS OF THE RIPRAP.
2. THE MIX PROPORTIONS PROVIDED IN TABLE 1 AND TABLE 2 ARE APPROXIMATE AND ARE SUBJECT TO ADJUSTMENT BY THE ENGINEER.
3. THE RIPRAP AND VOID-FILLED MATERIALS SHALL BE STOCKPILED SEPERATELY AND THOROUGHLY MIXED PRIOR TO PLACEMENT AND SHALL BE INSTALLED AND COMPACTED SO THAT A DENSE, INTERLOCKED LAYER OF RIPRAP AND VOID-FILL MATERIAL IS PROVIDED WITH RIPRAP VOIDS COMPLETELY FILLED. THE LOOSE MATERIAL SHALL BE PLACED IN A SINGLE LIFT OF SUFFICIENT HEIGHT SUCH THAT FINAL GRADE WILL BE ACHIEVED UPON COMPACTED. IF THE COMPACTED MATERIAL IS BELOW FINAL GRADE, PLACEMENT OF ONLY THE SMALLER VOID-FILL MATERIALS TO ACHIEVE FINAL GRADE IS NOT PERMITTED. IN SUCH CASES IT IS NECESSARY TO ADD MORE STANDARD SIZED VOID-FILLED RIPRAP AND REMIX THE ENTIRE THICKNESS OF ROCK TO ACHIEVE THE DESIGN SECTION. SEGREGATION OF MATERIALS SHALL BE AVOIDED AND IN NO CASE SHALL THE COMBINED MATERIAL CONSIST PRIMARILY OF THE VOID-FILL MATERIALS. THE DENSITY AND INTERLOCKING NATURE OF RIPRAP IN THE MIXED MATERIAL SHALL ESSENTIALLY BE THE SAME AS IF THE RIPRAP WAS PLACED WITHOUT FILLING THE VOIDS.
4. COMPACTION OF THE VOID-FILLED RIPRAP SHALL BE PERFORMED BY WHEEL ROLLING WITH HEAVY RUBBER-TIRED EQUIPMENT (E.G. FRONT END LOADER). THE MOISTURE CONTENT OF THE MIXTURE SHALL BE AT OPTIMUM CONDITIONS PRIOR TO COMPACTION AND WATER SHALL BE ADDED, AS NECESSARY, AT THE DIRECTION OF THE ENGINEER.
5. WHERE INDICATED ON THE DRAWINGS, A SURFACE LAYER OF MOIST TOPSOIL SHALL BE PLACED OVER THE VOID-FILLED RIPRAP. THE TOPSOIL SURFACE LAYER SHALL BE COMPACTED TO APPROXIMATELY 85% OF MAXIMUM DENSITY AND WITHIN TWO PERCENTAGE POINTS OF OPTIMUM MOISTURE IN ACCORDANCE WITH ASTM D698. TOPSOIL SHALL BE ADDED TO ANY AREAS THAT SETTLE.
6. ALL VOID-FILLED RIPRAP THAT IS BURIED WITH TOPSOIL SHALL BE REVIEWED AND APPROVED BY THE ENGINEER PRIOR TO ANY TOPSOIL PLACEMENT.

**Figure 8-35. Void-filled riprap placement and gradation (part 3 of 3)**



**GROUTED BOULDER EDGE DETAIL**



**GROUTED BOULDER STACKED WALL EDGE**

**Figure 8-36. Sample grouted boulder section**

## 9.0 References

American Association of State Highway and transportation Officials, 1999. *Guide for the Development of Bicycle Facilities*

American Society of Civil Engineers (ASCE). 1975. *Sedimentation Engineering*. American Society of Civil Engineers Manuals and Reports on Engineering Practice No. 54. New York: ASCE.

American Society of Civil Engineers and Water Environment Federation (ASCE and WEF). 1992. *Design and Construction of Urban Stormwater Management Systems*. American Society of Civil Engineers Manuals and Reports of Engineering Practice No. 77 and Water Environment Federation Manual of Practice FD-20. New York: American Society of Civil Engineers.

Arcement, G.J. Jr., and Schneider, V.R., 1989, *Guide for Selecting Manning's Roughness Coefficients for Natural Channel and Flood Plains*, US Geological Survey Water-Supply Paper 2339.

Barnes, H.H. Jr. 1967. *Roughness Characteristics of Natural Channels*. Geological Survey Water-Supply Paper 1849. Washington, D.C.: U.S. Government Printing Office.

Biedenbarn, D.S., C.M. Elliot, and C.C. Watson. 1997. *The WES Stream Investigation and Streambank Stabilization Handbook*. Vicksburg, MS: U.S. Army Corps of Engineers, Waterways Experiment Station.

Bledsoe, B. 2013. *Overview of Stream Restoration Paradigms, Approaches, and Tools*. Powerpoint Presentation from Stream Restoration Workshop.

Bohan, J.P. 1970 *Erosion and Riprap Requirements at Culverts and Storm Drain Outlets*. WES Research Report H-70-2. Vicksburg, MS: U.S. Army Corps of Engineers, Waterways Experiment Station.

Calhoun, C.C., J.R. Compton, and W.E. Strohm. 1971. *Performance of Plastic Filter Cloth as Replacement for Granular Filter Materials*, Highway Research Record No. 373, pp. 74–85. Washington, D.C.: Highway Research Board.

Chow, V.T. 1959. *Open-Channel Hydraulics*. New York: McGraw-Hill Book Company.

Daugherty, R.L. and J.B. Franzini. 1977. *Fluid Mechanics with Engineering Applications*. New York: McGraw Hill.

Denver Regional Council of Governments (DRCOG). 1983 *Urban Runoff Quality in the Denver Region*. Denver, CO: Denver Regional Council of Governments.

Dunne and Leopold. 1943. *Water in Environmental Planning*. New York: WH Freeman and Company.

Fischenich, C. 2001. *Stability Thresholds for Stream Restoration Materials*. Vicksburg, MS: U.S. Army Corps of Engineers, Ecosystem Management & Restoration Research Program (EMRRP).

Fletcher, B.P. and Grace, J. L.. 1972. *Practical Guidance for Estimating and Controlling Erosion at Culvert Outlets*, WES Miscellaneous Paper H-72-5. Vicksburg, MS: U.S. Army Corps of Engineers, Waterways Experiment Station.

Fortier, S. and F.C. Scobey. 1926. Permissible Canal Velocities. *Transactions of the American Society of Civil Engineers*, Volume 89, pp. 940-956.

- Guo, J. 1999. Roll Waves in High Gradient Channels. *Journal of Water International* 24(1)65-69.
- Hipschman, R.A. 1970. Erosion Protection for the Outlet of Small and Medium Culverts. Master Thesis, Civil Engineering Department, South Dakota State University.
- Jarrett, R., 1985, *Determination of Roughness Coefficients for Stream in Colorado*, US Geological Survey, Water-Resources Investigations Report 85-4004.
- King, H.W. and E.F. Brater. 1963. *Handbook of Hydraulics for the Solution of Hydrostatic and Fluid-Flow Problems*. New York: McGraw-Hill.
- Lane, E.W. 1952. *Progress Report on Results of Studies on Design of Stable Channels*. Hyd-352. Denver, CO: Department of Interior, Bureau of Reclamation.
- Lane, E.W. 1953. Progress Report on Studies on the Design of Stable Channels by the Bureau of Reclamation. *Proceedings of the American Society of Civil Engineers*. Volume 79. Separate No. 280, pp. 1-31. 1953.
- Lane, E.W. 1955a. Design of Stable Channels. *Transactions of the American Society of Civil Engineers*, Volume 120, pp. 1234–1260.
- Lane, E.W. 1955b. The Importance of Fluvial Morphology in Hydraulic Engineering. *Proceedings of the American Society of Civil Engineers*.
- Leopold, L.B. and T. Maddock Jr. 1953. *The Hydraulic Geometry of Stream Channels and Some Physiographic Implications*. Washington, DC: U.S. Geological Survey.
- Leopold, L.B. 1994. *A View of the River*. Cambridge, MA: Harvard University Press.
- Maricopa County. 2000. *Drainage Design Manual for Maricopa County*. Phoenix, AZ: Maricopa County, Arizona.
- Murphy, T.E. 1971. *Control of Scour at Hydraulic Structures*, WES Miscellaneous Paper H-71-5. Vicksburg, MS: U.S. Army Corps of Engineers, Waterways Experiment Station.
- Newbury and Gaboury. 1993. *Stream Analysis and Fish Habitat Design: A Field Manual*. Newberry Hydraulics Ltd. and the Manitoba Habitat Heritage Corporation.
- Posey, C.J. 1960. *Flood Erosion Protection for Highway Fills*. Bulletin No. 13. Ames, IA: Iowa Highway Research Board.
- Rhoads, B.L. 1995. Stream Power: A Unifying Theme for Urban Fluvial Geomorphology. In *Stormwater runoff and Receiving Systems*, E.E. Herricks, ed. Boca Raton, FL: CRC Press.
- Riley, A.L. 1998. *Restoring Streams in Cities: A Guide for Planners, Policymakers, and Citizens*. Washington, D.C.: Island Press. Washington.
- Rosgen, D. 1996. *Applied River Morphology*. Pagosa Springs, CO: Wildland Hydrology.
- Schiechtl, H. 1980. *Bioengineering for Land Reclamation and Conservation*. Edmonton, Alberta: University of Alberta Press.
- Simons, D.B. 1957. *Theory and Design of Stable Channels in Alluvial Materials*. Ph.D. dissertation,

Colorado State University. Fort Collins, CO.

Simons, D.B. and F. Senturk. 1992. *Sediment Transport Technology*. Littleton, CO: Water Publications.

Smith, C. D. 1975. Cobble Lined Structures. *Canadian Journal of Civil Engineering*, Volume 2.

Smith, C.D. 1974. *Hydraulic Structures*. Saskatoon, SK: University of Saskatchewan Printing Services.

Society of Ecological Restoration, Science and Policy Working Group. 2004. *SER International Primer and Ecological Restoration*.

Stevens, M.A., D.B. Simons, and F.J. Watts. 1971. *Riprapped Basins for Culvert Outfalls*. Highway Research Record No. 373. Washington, D.C.: Highway Research Service.

Stevens, M.A., D.B. Simons, and G.L. Lewis. 1976. Safety Factors for Riprap Protection. *Journal of the Hydraulics Division* 102 (5) 637–655.

U.S. Army Corps of Engineers (USACE). 1994. *Hydraulic Design of Flood Control Channels*. USACE Design Manual EM 1110–2–1601.

U.S. Army Corps of Engineers. 1991. *HEC-2, Water Surface Profiles, User's Manual*. Davis, CA: Army Corps of Engineers Hydrologic Engineering Center.

U.S. Army Corps of Engineers. 1995. *HEC-RAS, River Analysis System, User's Manual*. Davis, CA: Army Corps of Engineers Hydrologic Engineering Center.

U.S. Army Corps of Engineers. Copeland et.al. 2001. *Hydraulic Design of Stream Restoration Projects*. Coastal and Hydraulic Laboratory. ERDC/CHL TR-01-28.

U.S. Army Corps of Engineers. P.J. Soar and C.R. Thorne. 2001. *Channel Restoration Design for Meandering Rivers*. Coastal and Hydraulic Laboratory. ERDC/CHL CR-01-1

U.S. Bureau of Reclamation (USBR). 1984. *Computing Degradation and Local Scour*. Washington, DC: Bureau of Reclamation.

U.S. Department Of Agriculture (USDA). 2007. *National Handbook Part 654: Stream Restoration Design*.

U.S. Department Of Agriculture. 2007. Technical Supplement 14I: Streambank Soil Bioengineering.

U.S. Department Of Agriculture. 1994. *Stream Channel Reference Site: an Illustrated Guide to Field Technique*.

U.S. Department Of Agriculture. 1987. *Agriculture Handbook Number 667: Stability Design of Grass-Lined Open Channels*.

USDA Natural Resources Conservation Service, September 2014, *Guidance for Stream Restoration, Technical Notes, Engineering – No. 27.3*.

U.S. Department of Agriculture, Soil Conservation Service, revised June 1954, *Handbook of Channel Design for Soil and Water Conservation*, Stillwater Outdoor Hydraulic Laboratory.

U.S. Environmental Protection Agency (USEPA). 1983. *Results of the Nationwide Urban Runoff Program: Final Report*. Washington D.C.: U.S. Environmental Protection Agency.

U.S. Federal Interagency Stream Restoration Working Group (USFISRWG). 1998. *Stream Corridor Restoration: Principles, Processes, and Practices*. Washington, DC: U.S. Federal Interagency Stream Restoration Working Group.

Urban Drainage and Flood Control District. 1982. Communications between Dr. Michael A. Stevens and UDFCD staff.

Urban Drainage and Flood Control District. 1984. *Guidelines for Development and Maintenance of Natural Vegetation*. Denver, CO: Urban Drainage and Flood Control District.

Urban Drainage and Flood Control District. 1986. *Comparison of Measured Sedimentation With Predicted Sediment Loads*. Technical Memorandum in response to District Agreement No. 85-02.078 from WRC Engineering, Inc., to the Urban Drainage and Flood Control District. Denver, CO: Urban Drainage and Flood Control District.

Vallentine, H. R. and B.A. Cornish. 1962. *Culverts with Outlet Scour Control*. University of New South Report No. 62. Sydney, Australia: Wales, Water Research Laboratory.

Watson, C.C., D.S. Biedenharn, and S.H. Scott, 1999. *Channel Rehabilitation: Process, Design, and Implementation*. Washington, D.C.: Environmental Protection Agency.

Watson, C.C., D.S. Biedenharn, B.P. Bledsoe. 2002. *Use of Incised Channel Evolution Models in Understanding Rehabilitation Alternatives*. Journal of the American Water Resources Association, American Water Resources Association.

Wulliman, J. and D. Johns. 2011. *Demonstration Projects Illustrating Void-Filled Riprap Applications in Stream Restoration*.

Yang, C.T, 1996. *Sediment Transport: Theory and Practice*. New York: The McGraw-Hill.